

Tentative Parcel Map

Washoe County Code (WCC) Chapter 110, Article 606, Tentative Parcel Map, prescribes the requirements for and waiver of, parcel maps. A parcel map shall be required for all subdivisions, merger, and re-subdivision of existing lots, and common-interest communities consisting of four (4) or fewer units. The Parcel Map Review Committee shall approve, conditionally approve, or deny the tentative parcel map within sixty (60) days of the date that the application is determined to be complete. See WCC 110.606, for further information.

Development Application Submittal Requirements

This sheet must accompany the original application and be signed by the Professional Land Surveyor.

1. **Fees:** See Master Fee Schedule. **Bring payment with your application to Community Services Department (CSD). Make check payable to Washoe County.** There may also be a fee due to the Engineering Department for Technical Plan Check.
2. **Development Application:** A completed Washoe County Development Application form.
3. **Owner Affidavit:** The Owner Affidavit must be signed and notarized by all owners of the property subject to the application request.
4. **Proof of Property Tax Payment:** The applicant must provide a written statement from the Washoe County Treasurer's Office indicating all property taxes for the current quarter of the fiscal year on the land have been paid.
5. **Application Materials:** The completed Tentative Parcel Map Application materials.
6. **Title Report:** A preliminary title report, with an effective date of no more than one hundred twenty (120) days of the submittal date, by a title company which provides the following information:
 - Name and address of property owners.
 - Legal description of property.
 - Description of all easements and/or deed restrictions.
 - Description of all liens against property.
 - Any covenants, conditions and restrictions (CC&Rs) that apply.

Submit Title Report with "Original Packet" only. You may be requested to provide additional copies, but do not include Title Report in other copies of the packet.
7. **Development Plan Specifications:** (If the requirement is "Not Applicable," please check the box preceding the requirement.)
 - a. Map to be drawn using engineering scales (e.g. scale 1" = 100', 1" = 200', or 1" = 500' unless a prior approval is granted by the County Surveyor) showing all streets and ingress/egress to the property and must meet NRS standards as specified in NRS 278.466.
 - b. Property boundary lines, distances and bearings.
 - c. Contours at five (5) foot intervals or two (2) foot intervals where, in the opinion of the County Engineer, topography is a major factor in the development.
 - d. The cross sections of all right-of-ways, streets, alleys or private access ways within the proposed development, proposed name and approximate grade of each, and approximate radius of all curves and diameter of each cul-de-sac.
 - e. The width and approximate location of all existing or proposed easements, whether public or private, for roads, drainage, sewers, irrigation, or public utility purposes.
 - f. If any portion of the land within the boundary of the development is subject to inundation or storm water overflow, as shown on the adopted Federal Emergency Management Agency's Flood Boundary and Floodway Maps, that fact and the land so affected shall be clearly

shown on the map by a prominent note on each sheet, as well as width and direction of flow of each water course within the boundaries of the development.

- g. The location and outline to scale of each existing building or structure that is not to be moved in the development.
 - h. Existing roads, trails or rights-of-way within the development shall be designated on the map.
 - i. Vicinity map showing the proposed development in relation to the surrounding area.
 - j. Date, north arrow, scale, and number of each sheet in relation to the total number of sheets.
 - k. Location of snow storage areas sufficient to handle snow removed from public and private streets, if applicable.
 - l. All known areas of potential hazard including, but not limited to, earth slide areas, avalanche areas or otherwise hazardous slopes, shall be clearly designated on the map. Additionally, active fault lines (post-Holocene) shall be delineated on the map.
8. **Street Names:** A completed "Request to Reserve New Street Name(s)" form (included in application packet). Please print all street names on the Tentative Map. Note whether they are existing or proposed.
9. **Packets:** Four (4) packets and a flash drive – any digital documents need to have a resolution of 300 dpi. One (1) packet must be labeled "Original" and contain a signed and notarized Owner Affidavit. Each packet shall include an 8.5" x 11" reduction of any large format sheets included in the application. These materials must be readable. Labeling on these reproductions should be no smaller than 8 point on the 8½ x 11" display. Each packet shall include: one (1) 8.5" x 11" reduction of any applicable site plan, development plan, and/or application map. Large format sheets should be included in a slide pocket(s). Any specialized reports identified above shall be included as attachments or appendices and be annotated as such.

- Notes:
- (i) Application and map submittals must comply with all specific criteria as established in the Washoe County Development Code and/or the Nevada Revised Statutes.
 - (ii) Based on the specific nature of the development request, Washoe County reserves the right to specify additional submittal packets, additional information and/or specialized studies to clarify the potential impacts and potential conditions of development to minimize or mitigate impacts resulting from the project. No application shall be processed until the information necessary to review and evaluate the proposed project is deemed complete by the Director of Planning and Building.
 - (iii) All oversized maps and plans must be folded to a 9" x 12" size.

I hereby certify, to the best of my knowledge,, all information contained in this application is correct and meets all Washoe County Development Code requirements.



Professional Land Surveyor

Washoe County Development Application

Your entire application is a public record. If you have a concern about releasing personal information, please contact Planning and Building staff at 775.328.6100.

Project Information		Staff Assigned Case No.: _____	
Project Name:			
Project Description:			
Project Address:			
Project Area (acres or square feet):			
Project Location (with point of reference to major cross streets AND area locator):			
Assessor's Parcel No.(s):	Parcel Acreage:	Assessor's Parcel No.(s):	Parcel Acreage:
Indicate any previous Washoe County approvals associated with this application: Case No.(s).			
Applicant Information (attach additional sheets if necessary)			
Property Owner:		Professional Consultant:	
Name:		Name:	
Address:		Address:	
Zip:		Zip:	
Phone: Fax:		Phone: Fax:	
Email:		Email:	
Cell: Other:		Cell: Other:	
Contact Person:		Contact Person:	
Applicant/Developer:		Other Persons to be Contacted:	
Name:		Name:	
Address:		Address:	
Zip:		Zip:	
Phone: Fax:		Phone: Fax:	
Email:		Email:	
Cell: Other:		Cell: Other:	
Contact Person:		Contact Person:	
For Office Use Only			
Date Received: Initial:		Planning Area:	
County Commission District:		Master Plan Designation(s):	
CAB(s):		Regulatory Zoning(s):	

Tentative Parcel Map Application Supplemental Information

(All required information may be separately attached)

1. What is the location (address or distance and direction from nearest intersection)?

--

- a. Please list the following:

APN of Parcel	Land Use Designation	Existing Acres

2. Please describe the existing conditions, structures, and uses located at the site:

--

3. What are the proposed lot standards?

	Parcel 1	Parcel 2	Parcel 3	Parcel 4
Proposed Minimum Lot Area				
Proposed Minimum Lot Width				

4. For parcel with split zoning what is the acreage/square footage of each zoning in the new parcels?

	Parcel 1	Parcel 2	Parcel 3	Parcel 4
Proposed Zoning Area				
Proposed Zoning Area				

5. Was the parcel or lot that is proposed for division created (recorded) within the last 5 years? (If yes, public review of the parcel map will be required. See Planning and Building staff for additional materials that are required to be submitted.)

<input type="checkbox"/> Yes	<input type="checkbox"/> No
------------------------------	-----------------------------

6. Utilities:

a. Sewer Service	
b. Electrical Service/Generator	
c. Water Service	

7. Please describe the source of the water facilities necessary to serve the proposed tentative parcel map:

- a. Water System Type:

<input type="checkbox"/> Individual wells		
<input type="checkbox"/> Private water	Provider:	
<input type="checkbox"/> Public water	Provider:	

b. Available:

<input type="checkbox"/> Now	<input type="checkbox"/> 1-3 years	<input type="checkbox"/> 3-5 years	<input type="checkbox"/> 5+ years
------------------------------	------------------------------------	------------------------------------	-----------------------------------

c. Washoe County Capital Improvements Program project?

<input type="checkbox"/> Yes	<input type="checkbox"/> No
------------------------------	-----------------------------

8. What sewer services are necessary to accommodate the proposed tentative parcel map?

a. Sewage System Type:

<input type="checkbox"/> Individual septic		
<input type="checkbox"/> Public system	Provider:	

b. Available:

<input type="checkbox"/> Now	<input type="checkbox"/> 1-3 years	<input type="checkbox"/> 3-5 years	<input type="checkbox"/> 5+ years
------------------------------	------------------------------------	------------------------------------	-----------------------------------

c. Washoe County Capital Improvements Program project?

<input type="checkbox"/> Yes	<input type="checkbox"/> No
------------------------------	-----------------------------

9. For most uses, the Washoe County Code, Chapter 110, Article 422, Water and Sewer Resource Requirements, requires the dedication of water rights to Washoe County when creating new parcels. Please indicate the type and quantity of water rights you have available should dedication be required:

a. Permit #		acre-feet per year	
b. Certificate #		acre-feet per year	
c. Surface Claim #		acre-feet per year	
d. Other, #		acre-feet per year	

a. Title of those rights (as filed with the State Engineer in the Division of Water Resources of the Department of Conservation and Natural Resources):

--

10. Does the property contain wetlands? (If yes, please attach a preliminary delineation map and describe the impact the proposal will have on the wetlands. Impacts to the wetlands may require a permit issued from the U.S. Army Corps of Engineers.)

<input type="checkbox"/> Yes	<input type="checkbox"/> No	If yes, include a separate set of attachments and maps.
------------------------------	-----------------------------	---

11. Does property contain slopes or hillsides in excess of 15 percent and/or significant ridgelines? (If yes, and this is the second parcel map dividing this property, Article 424, Hillside Development of the Washoe County Development Code will apply.)

<input type="checkbox"/> Yes	<input type="checkbox"/> No	If yes, include a separate set of attachments and maps.
------------------------------	-----------------------------	---

12. Does property contain geologic hazards such as active faults; hillside or mountainous areas; is it subject to avalanches, landslides, or flash floods; is it near a water body, stream, Significant Hydrologic Resource as defined in Article 418, or riparian area such as the Truckee River, and/or an area of groundwater recharge

<input type="checkbox"/> Yes	<input type="checkbox"/> No	If yes, include a separate set of attachments and maps.
------------------------------	-----------------------------	---

13. Does the tentative parcel map involve common open space as defined in Article 408 of the Washoe County Development Code? (If so, please identify all proposed non-residential uses and all the open space parcels.)?

<input type="checkbox"/> Yes	<input type="checkbox"/> No	If yes, include a separate set of attachments and maps.
------------------------------	-----------------------------	---

14. If private roads are proposed, will the community be gated? If so, is a public trail system easement provided through the subdivision?

--

15. Are there any applicable policies of the adopted area plan in which the project is located that require compliance? If so, which policies and how does the project comply.

<input type="checkbox"/> Yes	<input type="checkbox"/> No	If yes, include a separate set of attachments and maps.
------------------------------	-----------------------------	---

16. Are there any applicable area plan modifiers in the Development Code in which the project is located that require compliance? If so, which modifiers and how does the project comply?

--

17. Is the project subject to Article 418, Significant Hydrologic Resources? If yes, please address Special Review Considerations within Section 110.418.30 in a separate attachment.

<input type="checkbox"/> Yes	<input type="checkbox"/> No	If yes, include a separate set of attachments and maps.
------------------------------	-----------------------------	---

Grading

Please complete the following additional questions if the project anticipates grading that involves: (1) Disturbed area exceeding twenty-five thousand (25,000) square feet not covered by streets, buildings and landscaping; (2) More than one thousand (1,000) cubic yards of earth to be imported and placed as fill in a special flood hazard area; (3) More than five thousand (5,000) cubic yards of earth to be imported and placed as fill; (4) More than one thousand (1,000) cubic yards to be excavated, whether or not the earth will be exported from the property; or (5) If a permanent earthen structure will be established over four and one-half (4.5) feet high. If your project exceeds any of the above criteria, you shall either provide a preliminary grading and roadway design plan for review OR if these criteria are exceeded with the final construction drawings and not disclosed at the Tentative Parcel Map Application, you shall be required to apply for a special use permit for grading and you will be delayed up to three months, if approved.

18. How many cubic yards of material are you proposing to excavate on site?

--

19. How many cubic yards of material are you exporting or importing? If exporting of material is anticipated, where will the material be sent? If the disposal site is within unincorporated Washoe County, what measures will be taken for erosion control and revegetation at the site? If none, how are you balancing the work on-site?

20. Can the disturbed area be seen from off-site? If yes, from which directions, and which properties or roadways? What measures will be taken to mitigate their impacts?

21. What is the slope (Horizontal/Vertical) of the cut and fill areas proposed to be? What methods will be used to prevent erosion until the revegetation is established?

22. Are you planning any berms and, if so, how tall is the berm at its highest? How will it be stabilized and/or revegetated?

23. Are retaining walls going to be required? If so, how high will the walls be, will there be multiple walls with intervening terracing, and what is the wall construction (i.e. rockery, concrete, timber, manufactured block)? How will the visual impacts be mitigated?

24. Will the grading proposed require removal of any trees? If so, what species, how many, and of what size?

25. What type of revegetation seed mix are you planning to use and how many pounds per acre do you intend to broadcast? Will you use mulch and, if so, what type?

26. How are you providing temporary irrigation to the disturbed area?

27. Have you reviewed the revegetation plan with the Washoe Storey Conservation District? If yes, have you incorporated their suggestions?

28. Surveyor:

Name	
Address	
Phone	
Cell	
E-mail	
Fax	
Nevada PLS #	

Property Owner Affidavit

Applicant Name: Tara Ruth Feickert

The receipt of this application at the time of submittal does not guarantee the application complies with all requirements of the Washoe County Development Code, the Washoe County Master Plan or the applicable area plan, the applicable regulatory zoning, or that the application is deemed complete and will be processed.

STATE OF NEVADA)
COUNTY OF WASHOE)

I, Tara Ruth Feickert
(please print name)

being duly sworn, depose and say that I am the owner* of the property or properties involved in this application as listed below and that the foregoing statements and answers herein contained and the information herewith submitted are in all respects complete, true, and correct to the best of my knowledge and belief. I understand that no assurance or guarantee can be given by members of Planning and Building.

(A separate Affidavit must be provided by each property owner named in the title report.)

Assessor Parcel Number(s): 077-560-05

Printed Name Tara Ruth Feickert

Signed [Signature]

Address 1209 Mallard Crest Dr
Sparks NV 89441

Subscribed and sworn to before me this 6th day of June 2022

[Signature]
Notary Public in and for said county and state

My commission expires: 5/6/2023

(Notary Stamp)

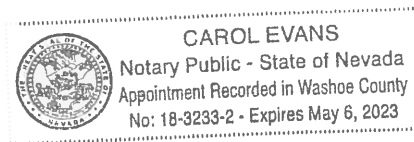

*Owner refers to the following: (Please mark appropriate box.)

- Owner
- Corporate Officer/Partner (Provide copy of record document indicating authority to sign.)
- Power of Attorney (Provide copy of Power of Attorney.)
- Owner Agent (Provide notarized letter from property owner giving legal authority to agent.)
- Property Agent (Provide copy of record document indicating authority to sign.)
- Letter from Government Agency with Stewardship

DIRECTOR OF PLANNING AND BUILDING CERTIFICATE

THE FINAL PARCEL MAP CASE NO. _____, MEETS ALL APPLICABLE STATUTES, ORDINANCES AND CODE PROVISIONS; IS IN SUBSTANTIAL CONFORMANCE WITH THE TENTATIVE MAP AND ITS CONDITIONS, WHICH ARE INCORPORATED HEREIN BY THIS REFERENCE, AND THOSE CONDITIONS HAVE BEEN SATISFIED FOR RECORDATION OF THIS MAP. THE OFFER(S) OF DEDICATION IS (ARE) REJECTED AT THIS TIME, BUT WILL REMAIN OPEN IN ACCORDANCE WITH NEVADA REVISED STATUTES CHAPTER 278. THIS FINAL MAP IS APPROVED AND ACCEPTED THIS _____ DAY OF _____, 2022, BY THE DIRECTOR OF PLANNING AND BUILDING OF WASHOE COUNTY, NEVADA, IN ACCORDANCE WITH NEVADA REVISED STATUTES 278.471 THROUGH 278.4725.

MOJRA HAUENSTEIN, DIRECTOR, PLANNING AND BUILDING DIVISION

DISTRICT BOARD OF HEALTH CERTIFICATE

THIS MAP IS APPROVED BY THE WASHOE COUNTY DISTRICT BOARD OF HEALTH. THIS APPROVAL CONCERNS SEWAGE DISPOSAL, WATER POLLUTION, WATER QUALITY, AND WATER SUPPLY FACILITIES. THIS MAP HAS BEEN FOUND TO MEET ALL APPLICABLE REQUIREMENTS AND PROVISIONS OF THE ENVIRONMENTAL HEALTH SERVICES DIVISION OF THE WASHOE COUNTY HEALTH DISTRICT.

FOR THE DISTRICT BOARD OF HEALTH DATE

TAX CERTIFICATE

THE UNDERSIGNED HEREBY CERTIFIES THAT ALL PROPERTY TAXES ON THE LAND FOR THE FISCAL YEAR HAVE BEEN PAID AND THAT THE FULL AMOUNT OF ANY DEFERRED PROPERTY TAXES FOR THE CONVERSION OF THE PROPERTY FROM AGRICULTURAL USE HAS BEEN PAID PURSUANT TO N.R.S. 361A.265.

APN 077-560-05
WASHOE COUNTY TREASURER

TREASURER DATE

WATER AND SEWER RESOURCE CERTIFICATE

THE PROJECT/DEVELOPMENT DEPICTED ON THIS MAP IS IN CONFORMANCE WITH THE PROVISIONS OF ARTICLE 442 OF WASHOE COUNTY CHAPTER 110 (DEVELOPMENT CODE).

WASHOE COUNTY COMMUNITY SERVICES DEPARTMENT DATE

NAME: _____

TITLE: _____

UTILITY COMPANIES CERTIFICATE

THE UTILITY EASEMENTS SHOWN ON THIS PLAT TO BE GRANTED OR TO REMAIN HAVE BEEN CHECKED, ACCEPTED AND APPROVED BY THE UNDERSIGNED PUBLIC UTILITY COMPANIES, CABLE TV COMPANIES AND TRUCKEE MEADOWS WATER AUTHORITY.

CHARTER COMMUNICATIONS DATE

NAME: _____

TITLE: _____

NEVADA BELL TELEPHONE COMPANY DATE
D/B/A AT&T NEVADA

NAME: _____

TITLE: _____

SIERRA PACIFIC POWER COMPANY DATE
D/B/A NV ENERGY

NAME: _____

TITLE: _____

TRUCKEE MEADOWS WATER AUTHORITY DATE

NAME: _____

TITLE: _____



VICINITY MAP
(NOT TO SCALE)

SURVEYOR'S STATEMENT

I, GENE FEICKERT JR., A PROFESSIONAL LAND SURVEYOR LICENSED IN THE STATE OF NEVADA, CERTIFY THAT:

1. THIS PLAT REPRESENTS THE RESULTS OF A SURVEY CONDUCTED UNDER MY DIRECT SUPERVISION AT THE INSTANCE OF MYSELF AND TARA FEICKERT.
2. THE LANDS SURVEYED LIE WITHIN A PORTION OF SECTION 3, T22N, R21E, M.D.M., WASHOE COUNTY, NEVADA, AND THE SURVEY WAS COMPLETED ON MARCH 2, 2022.
3. THIS PLAT COMPLIES WITH THE APPLICABLE STATE STATUTES AND ANY LOCAL ORDINANCES IN EFFECT ON THE DATE THAT THE GOVERNING BODY GAVE ITS FINAL APPROVAL.
4. THE MONUMENTS DEPICTED ON THE PLAT ARE OF THE CHARACTER SHOWN, OCCUPY THE POSITIONS INDICATED AND ARE OF SUFFICIENT NUMBER AND DURABILITY.

DATE: _____

GENE FEICKERT JR. P.L.S.
L.S. NO. 6608
EXPIRES: DECEMBER 31, 2009

TITLE COMPANY CERTIFICATE

THE UNDERSIGNED HEREBY CERTIFIES THAT THIS PARCEL MAP HAS BEEN EXAMINED AND THAT GENE FEICKERT, JR. AND TARA FEICKERT ARE THE LAST TITLE HOLDERS OF RECORD FOR ALL THE LANDS DELINEATED HEREON AND THAT NO ONE HOLDS OF RECORD A SECURITY INTEREST IN THE LANDS AND THAT THERE ARE NO LIENS OF RECORD AGAINST THE OWNERS FOR DELINQUENT STATE, COUNTY, MUNICIPAL, FEDERAL OR LOCAL TAXES COLLECTED AS TAXES OR SPECIAL ASSESSMENTS, EXCEPT: _____, AS OF _____

FIRST CENTENNIAL TITLE COMPANY OF NEVADA.

DATE

NAME: _____

TITLE: _____

COUNTY SURVEYOR'S CERTIFICATE

I HEREBY CERTIFY THAT I HAVE EXAMINED THIS PLAT AND PERFORMED A TECHNICAL MAP CHECK OF THE GEOMETRIC DATA SHOWN HEREON AND THAT I AM SATISFIED THAT THE MAP IS TECHNICALLY CORRECT.

WAYNE HANDROCK, PLS
WASHOE COUNTY SURVEYOR

OWNER'S CERTIFICATE

THIS IS TO CERTIFY THAT THE UNDERSIGNED, GENE FEICKERT, JR. AND TARA FEICKERT, ARE THE OWNERS OF THE TRACT OF LAND REPRESENTED ON THIS PLAT AND HAVE CONSENTED TO THE PREPARATION AND RECORDATION OF THIS PLAT, AND THAT THE SAME IS EXECUTED IN COMPLIANCE WITH AND SUBJECT TO THE PROVISIONS OF N.R.S. CHAPTER 278. THE PUBLIC UTILITY EASEMENTS AS SHOWN OR NOTED HEREON ARE HEREBY GRANTED TOGETHER WITH THE RIGHT OF ACCESS TO ALL PUBLIC UTILITY COMPANIES, CABLE TELEVISION COMPANIES, AND TRUCKEE MEADOWS WATER AUTHORITY, THEIR SUCCESSORS AND ASSIGNS.

GENE FEICKERT, JR.

GENE FEICKERT, JR. DATE

TARA FEICKERT

TARA FEICKERT DATE

NOTARY PUBLIC CERTIFICATE

STATE OF _____ }
COUNTY OF _____ } SS

THIS INSTRUMENT WAS ACKNOWLEDGED BEFORE ME ON _____

BY GENE FEICKERT, JR. WHO PERSONALLY APPEARED BEFORE ME, A NOTARY PUBLIC, WHO ACKNOWLEDGED THAT HE EXECUTED THE ABOVE INSTRUMENT.

NOTARY PUBLIC
(MY COMMISSION EXPIRES _____)

NOTARY PUBLIC CERTIFICATE

STATE OF _____ }
COUNTY OF _____ } SS

THIS INSTRUMENT WAS ACKNOWLEDGED BEFORE ME ON _____

BY TARA FEICKERT WHO PERSONALLY APPEARED BEFORE ME, A NOTARY PUBLIC, WHO ACKNOWLEDGED THAT HE EXECUTED THE ABOVE INSTRUMENT.

NOTARY PUBLIC
(MY COMMISSION EXPIRES _____)

<p>FILE NUMBER _____</p> <p>FILED FOR RECORD AT THE REQUEST OF _____</p> <p>ON THIS ____ DAY OF _____</p> <p>20__ AT __MIN PAST O'CLOCK __M.</p> <p>OFFICIAL RECORDS OF WASHOE COUNTY, NEVADA.</p> <p>COUNTY RECORDER _____</p> <p>BY: _____ DEPUTY</p> <p>FEE: _____</p>	<p>TENTATIVE PARCEL MAP FOR GENE JAMES FEICKERT, JR. AND TARA RUTH FEICKERT</p> <p>BEING A DIVISION OF A PORTION OF PARCEL 3-2-1-4 OF RECORD OF SURVEY MAP NO. 1010</p> <p>LOCATED WITHIN A PORTION OF SECTION 3, T22N, R21E, M.D.M. COUNTY OF WASHOE, STATE OF NEVADA SHEET 1 OF 2</p> <hr/> <p>PREPARED BY F3 & Associates, Inc. LAND SURVEYING 145 ISIDOR CT., SUITE B, • SPARKS • NV • 89441</p>
---	--

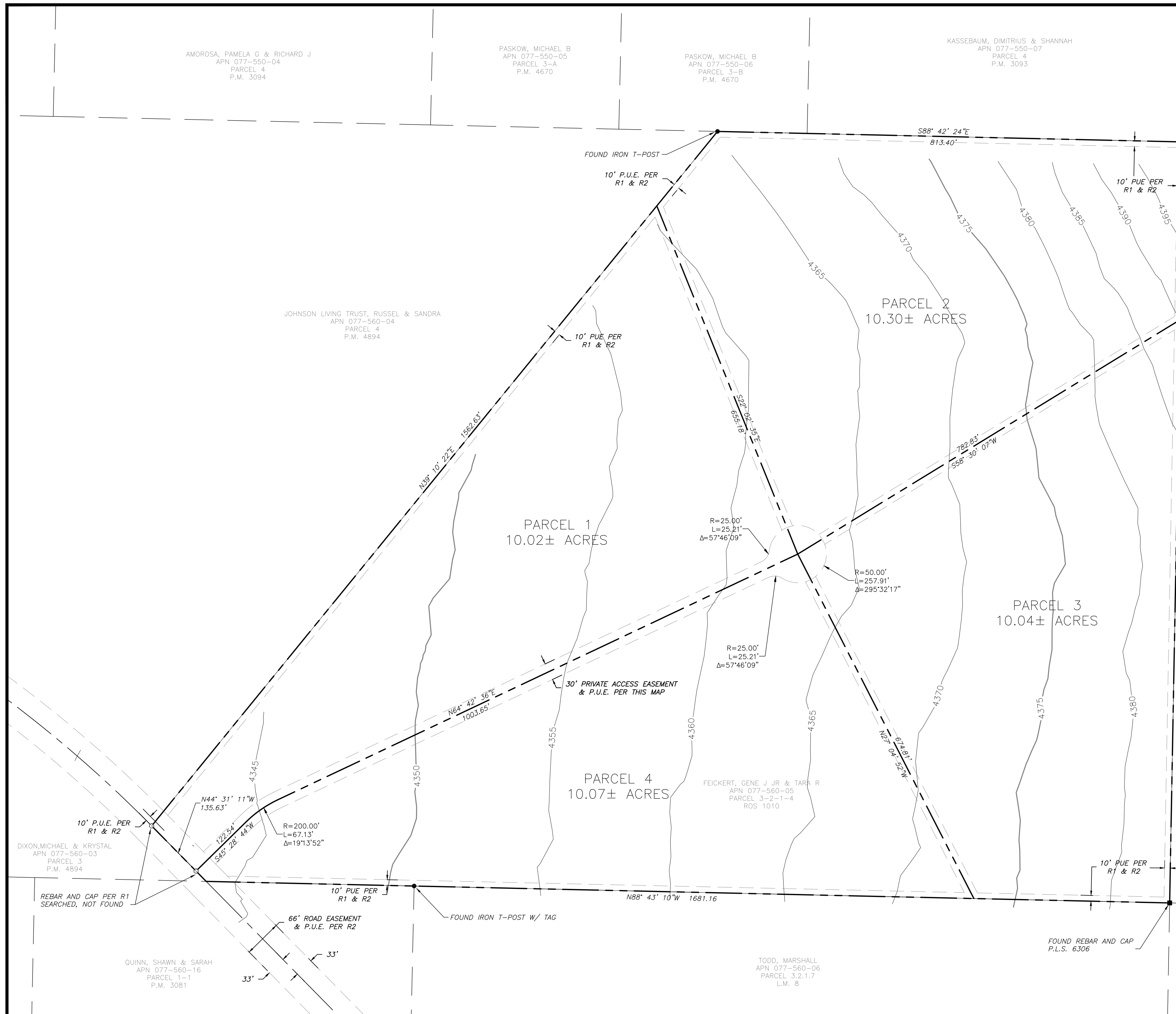

LEGEND AND ABBREVIATIONS

	PROPERTY LINE
	ROAD CENTERLINE
	EASEMENT LINE
	ADJOINING PROPERTY LINE
	MAJOR CONTOURS (25' INTERVAL)
	MINOR CONTOURS (5' INTERVAL)

L.M.	LAND MAP
P.M.	PARCEL MAP
P.U.E.	PUBLIC UTILITY EASEMENT

- REFERENCES**
- RECORD OF SURVEY MAP NO. 1010, FILE NO. 434699, OFFICIAL RECORDS, WASHOE COUNTY, NEVADA.
 - MAP OF DIVISION INTO LARGE PARCELS NO. 14, FILE NO. 434701, OFFICIAL RECORDS, WASHOE COUNTY, NEVADA.
 - MAP OF DIVISION INTO LARGE PARCELS NO. 151, FILE NO. 1883894, OFFICIAL RECORDS, WASHOE COUNTY, NEVADA.
 - MAP OF DIVISION INTO LARGE PARCELS NO. 243, FILE NO. 4502432, OFFICIAL RECORDS, WASHOE COUNTY, NEVADA.
 - PARCEL MAP 3081, FILE NO. 2021513, OFFICIAL RECORDS, WASHOE COUNTY, NEVADA.
 - PARCEL MAP 3093, FILE NO. 2029426, OFFICIAL RECORDS, WASHOE COUNTY, NEVADA.
 - PARCEL MAP 3094, FILE NO. 2029427, OFFICIAL RECORDS, WASHOE COUNTY, NEVADA.
 - PARCEL MAP 4670, FILE NO. 3448324, OFFICIAL RECORDS, WASHOE COUNTY, NEVADA.
 - PARCEL MAP 4894, FILE NO. 3632739, OFFICIAL RECORDS, WASHOE COUNTY, NEVADA.

BASIS OF BEARINGS
 U.S.C & G.S. STATIONS -
 JUNCTION HOUSE TO MONTE = N. 52°09'01" E.

AREA SUMMARY

PARCEL 1	= 10.02± ACRES
PARCEL 2	= 10.30± ACRES
PARCEL 3	= 10.04± ACRES
PARCEL 4	= 10.07± ACRES
TOTAL AREA	= 40.43± ACRES

GENERAL NOTES

- ACCORDING TO FEMA FLOOD INSURANCE RATE MAP NO. 32031C2700G, REVISED MARCH 16, 2009, THE SURVEYED PROPERTY (APN 077-560-05) IS LOCATED ENTIRELY WITHIN UNSHADED ZONE X (AREAS DETERMINED TO BE OUTSIDE THE 0.2% ANNUAL CHANCE FLOODPLAIN).
- ALL PROPERTIES, REGARDLESS IF THEY ARE LOCATED WITHIN OR OUTSIDE OF A FEMA DESIGNATED FLOOD ZONE, MAY BE SUBJECT TO FLOODING. EACH PROPERTY OWNER IS REQUIRED TO MAINTAIN ALL DRAINAGE EASEMENTS AND NATURAL DRAINAGES AND NOT PERFORM OR ALLOW UNPERMITTED AND/OR UNAPPROVED MODIFICATIONS TO THE PROPERTY THAT MAY HAVE DETRIMENTAL IMPACTS TO THE SURROUNDING PROPERTIES.
- NATURAL DRAINAGE WILL NOT BE IMPEDED DURING THE DEVELOPMENT OR IMPROVEMENT OF THESE PARCELS.
- PUBLIC UTILITY EASEMENTS ARE HEREBY GRANTED 10' IN WIDTH ALONG AND ADJACENT TO ALL INTERIOR PROPERTY LINES PER R2.
- PUBLIC UTILITY EASEMENTS SHALL INCLUDE USE BY CABLE TELEVISION AND TRUCKEE MEADOWS WATER AUTHORITY.
- ALL PREVIOUSLY ESTABLISHED EASEMENTS ARE TO REMAIN.

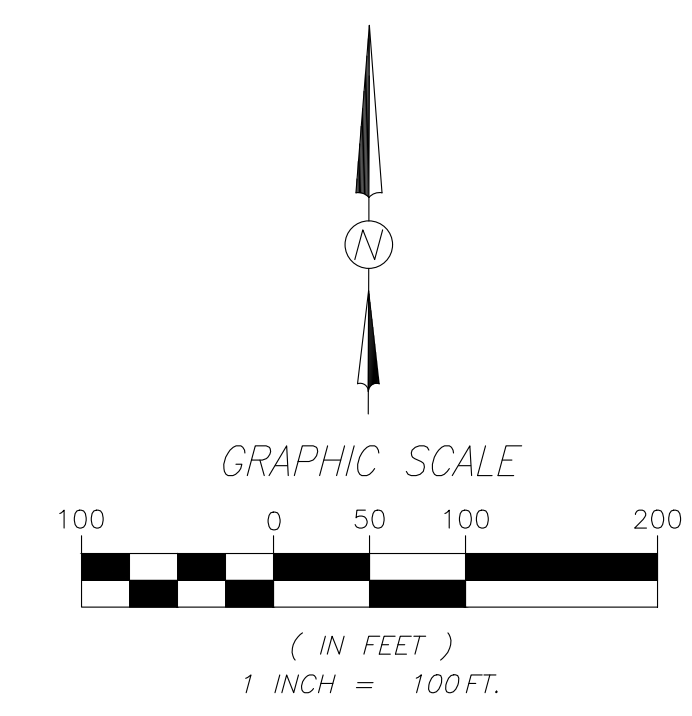
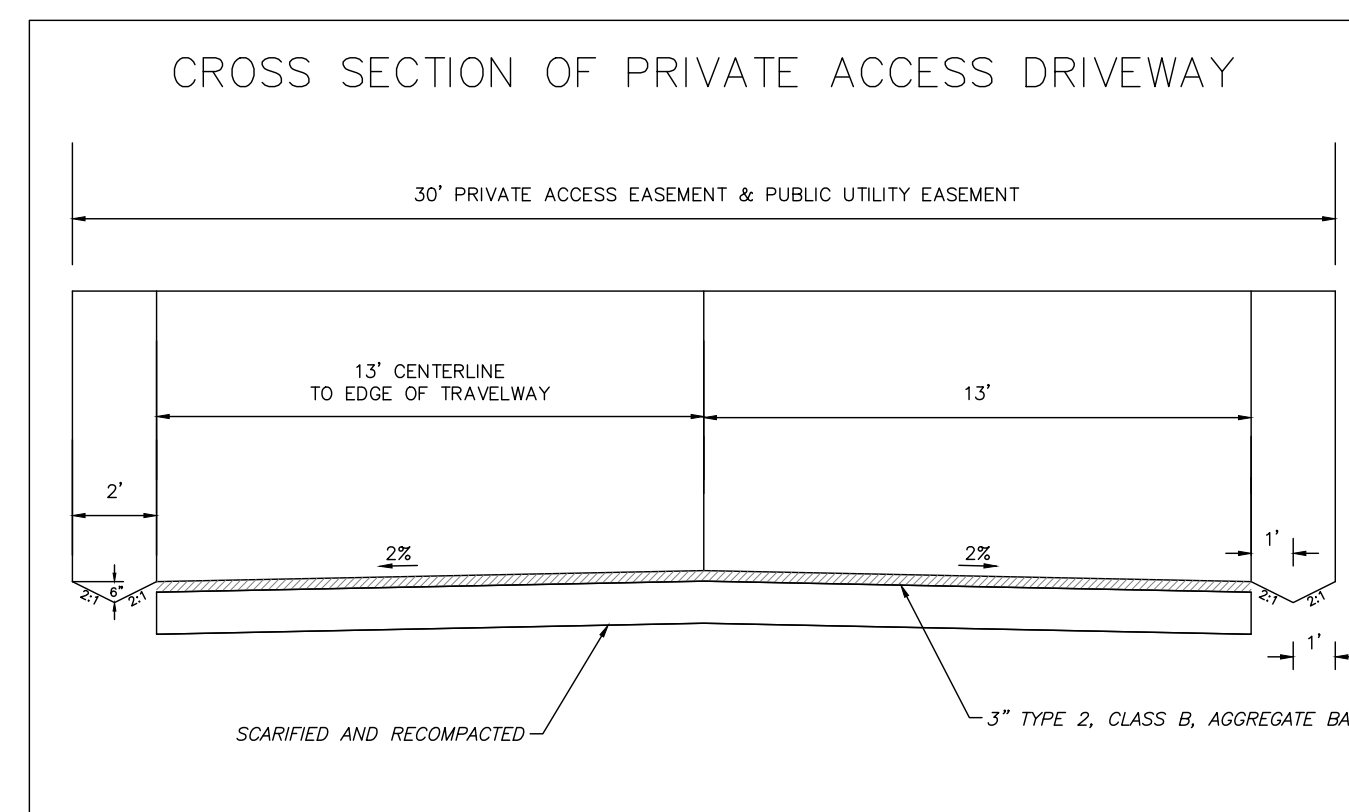

TENTATIVE PARCEL MAP
 FOR
GENE JAMES FEICKERT, JR. AND TARA RUTH FEICKERT
 BEING A DIVISION OF A PORTION OF
 PARCEL 3-2-1-4 OF RECORD OF SURVEY MAP NO. 1010
 LOCATED WITHIN A PORTION OF SECTION 3,
 T22N, R21E, M.D.M.
 COUNTY OF WASHOE, STATE OF NEVADA
 SHEET 2 OF 2

PREPARED BY
F3 & Associates, Inc.
 LAND SURVEYING
 145 ISIDOR CT., SUITE B, SPARKS • NV • 89441

DEVELOPMENT AGREEMENT
PURSUANT TO WASHOE COUNTY CODE SECTION 110

THIS AGREEMENT (“Agreement”) is made by and between, on the one hand, Gene James Feickert, Jr. and Tara Ruth Feickert, husband and wife, their agents and successors including developers and eventual subdivided parcel owners (collectively the “Landowner”), and, on the other hand, the County of Washoe, a political subdivision of the State of Nevada (“County”).

WITNESSETH:

WHEREAS, the County is authorized, pursuant to Nevada Revised Statutes (“NRS”) § 278.0201, *et seq.*, and Washoe County Development Code (“Code”) § 110.814.00, *et seq.*, to enter into binding development agreements with persons having legal or equitable interests in real property for the purpose of establishing and strengthening long-range plans for property development and providing for developer funding of certain public facilities to serve new development;

WHEREAS, Landowner represents that he and she have complete and sole fee title ownership of the subject real property, the legal description of which is set forth on Exhibit “A” attached hereto and shown in the next identified exhibit;

WHEREAS, the Parties desire to enter into this Agreement in accordance with NRS and Code, as applicable, to promote the health, safety, and general welfare of the County’s inhabitants; to help provide some public services, uses, and infrastructure, for which Landowner voluntarily offers to pay; to secure to Landowner certain land development safeguards and rights; and to achieve the goals and purposes for which the referenced development agreement laws were enacted;

WHEREAS, it is the Parties’ desire that this Agreement satisfy certain of the infrastructure and development provisions of the County’s Warm Springs Area Plan, which was approved by the Washoe County Board of Commissioners on January 12, 2012 and thereafter amended.

WHEREAS, it is the Parties’ further desire that this Agreement satisfy certain of the infrastructure and development provisions of the County’s specific plan for part of the general Warm Springs area in which this Property is located, the specific plan being known as the Warm Springs Specific Plan, which was approved by the Washoe County Board of Commissioners on September 22, 1992, as amended and including the third printing done May 2, 2019;

NOW, THEREFORE, the Parties agree as follows:

1. GENERAL

1.1 Property. The Landowner is the owner of real property located in Washoe County, Nevada known as Assessor's Parcel Number 077-560-05, consisting of approximately 40 acres in Warm Springs area (the "Property") as more particularly described in Exhibit "A", attached hereto.

1.2 Large Acreage Residential Improvements. There are no improvements currently made to the Property; it is undeveloped land. The Parties agree that the Property shall be divided and improvements constructed strictly for single, large-acreage, residential purposes, namely the division of the 40-acre parcel into four, ten-acre lots (the "Project"). (See plot map, attached hereto as Exhibit "B.") The Project will be constructed and the work of improvements performed in accordance with the Washoe County Comprehensive Plan, the Warm Springs Area Plan, the Warm Springs Specific Plan, the Warm Springs Specific Plan Development Standards Handbook Framework (collectively the "Warm Springs Plans"), the Code, and the NRS all in effect on the date of the County's tentative map approval and as reflected in this Agreement, including its attached exhibits. Landowner shall subdivide to a density allowed by the foregoing Warm Springs Plans, laws, rules, and regulations, as shown on any tentative or final maps. However, Landowner and their successors reserve the option to further subdivide the Property and its parcels in the future, pursuant to then-existing law, if and when the Warm Springs Plans and the Washoe County Health Department permit it.

1.3 Previous Maps. Landowner has not recorded any tentative or final map for any portion of the project.

2. AGREEMENT CONCERNING DEVELOPMENT OF LAND.

2.1 Compliance with NRS 278.0201, the Code, and this Agreement constitute an agreement concerning the development of land under NRS 278.0201 and Article 814 of the Code. The Landowner is the owner of fee title to the Property, and therefore has a legal interest in the Property. In compliance with NRS 278.0201(1), the following covenants, terms and conditions are set forth:

2.1.1 The land which is subject to this Agreement is Assessor's Parcel Number 077-560-05, consisting of approximately 40 acres, more particularly described in Exhibit "A": Legal Description.

2.1.2 The duration of this Agreement shall be from the date of signing by the Board of County Commissioners, for an initial period of one year, provided that all the terms of this Agreement shall remain binding and enforceable regarding construction or development commenced, and any related permits, on any portion

of the Property subject to a tentative map, a recorded final map, or any sue permit in existence at the time of expiration of this Agreement.

2.1.3 The permitted uses on the Property and the density or intensity of its use, are as provided in the Warm Springs Plans and the Code. The Property is currently designated “Medium Density Rural,” on the Warm Springs Specific Plan Land Use Plan, as depicted in Exhibit “C” hereto. This designation, the Code states,

is intended to preserve areas where agriculture, grazing and/or open space predominate. Single-family, detached residences in this area are generally on five (5)-acre lots and have limited public services and facilities available. Multi-family residences are not appropriate, but single-family homes may be clustered to retain open space and agricultural uses. The maximum number of dwelling units that may be located in this regulatory zone is one (1) unit per five (5) acres. The minimum lot area in this regulatory zone is four (4) acres.

Section 110.106.15(d). Similarly, The Warm Springs Specific Plan permits development “at an overall density of one dwelling unit per 2.5 acres on individual domestic well,” (p. 22), which complies with the Property’s land use designation. *See also* Warm Springs Area Plan, p. 16 (“The overall average residential density in the Warm Springs SPA will not exceed one dwelling unit per two and one-half acres.”).

2.1.4 The maximum height and size of the proposed buildings will comply with the Warm Springs Plans and the Code.

2.1.5 The provisions for the dedication of any portion of the Property for public uses, if any, will be provided in a forthcoming tentative map and the Code. There are no environmentally sensitive lands or historic structures on the Property.

2.1.6 Terms and conditions relating to construction and financing of necessary public improvements and facilities, if any, are in accordance with and as provided for in the Warm Springs Plans and the Code, and will also be in accordance with any subdivision improvement agreements for future, final maps.

2.1.7 Phasing and deadline dates for project grading and development with information on required bonding or other acceptable guarantees of performance and completion (Article 110.610 Washoe County Development Code) for each development phase or state will be addressed with the submittal of each final map.

2.1.8 The final map, to be a minimum of four lots, shall be presented to the Planning Commission on or before the date of expiration of this Agreement. All

successive final maps, if the Landowner chooses to record in a series, must include a minimum of four lots. Unless otherwise provided herein, the deadlines for any final maps shall be governed by NRS 278.360.

2.1.9 Development standards for the Project will be set forth in the conditions and requirements of any forthcoming tentative map, any forthcoming action order issued by the Board of County Commission, and future, final maps.

2.2 Code and Changes to the Law. The Parties agree that changes in federal, state, or county law concerning public health, safety, or welfare will apply to any final map or other permit.

2.3 Public Notice. Any and all public notices required to be given in connection with this Agreement shall be given in accordance with NRS Chapter 278 and Section 110.814.25 of the Code.

2.4 Assumption of Risk. The Landowner acknowledges and agrees that the Landowner is proceeding voluntarily and at its own risk in entering into this Agreement and without advice, promises, or guarantees of any kind from the County, other than as expressly set forth herein. The Landowner waives any claims for damages against the county that might arise out of, or relate to, a subsequent court determination that this Agreement or any provision in it is invalid and/or unenforceable, including any claim based on NRS 278.0233(1) regarding the requirements, limitations, or conditions imposed pursuant to this Agreement.

2.5 Default and Termination of Agreement. This Agreement shall become null and void, in the event of noncompliance with any term or deadline set forth in this Agreement if the breaching party fails to fully cure such noncompliance after reasonable written notice and opportunity to cure, provided that all the terms of this Agreement shall remain binding and enforceable regarding construction or development commenced, and any related permits, on any portion of the Property subject to a tentative map, a recorded final map, or any use permit in existence at the time of termination of this Agreement.

3. MISCELLANEOUS PROVISIONS.

3.1 Time is of the Essence. Time is of the essence of this Agreement.

3.2 Waivers. No waiver of any breach of any covenant or provision herein contained shall be deemed a waiver of any preceding or succeeding breach thereof, or of any other covenant or provision herein contained. No extension of time for performance of any obligation or act shall be deemed an extension of time for performance of any other obligation or act except those of the waiving party, which shall be extended by a period of time equal to the period of the delay.

3.3 Assignment of the Agreement. This Agreement shall be binding upon and inure to the benefit of all future successors in interest of the Property as described in Exhibit “A” (Legal Description), and the successor shall assume the duties and obligations under this Agreement.

3.4 Entire Agreement. This Agreement is the final expression of, and contains the entire agreement between, the parties with respect to the subject matter hereof and supersedes all prior understandings with respect thereto.

3.5 Governing Law. The parties hereto acknowledge that this Agreement has been negotiated and entered into in the State of Nevada. The parties hereto expressly agree that this Agreement shall be governed by, interpreted under, and construed and enforced in accordance with the laws of the State of Nevada and venue for any action shall be solely in state district court for Washoe County, Nevada.

3.6 Dates of Week. If any date for performance herein falls on a Saturday, Sunday or holiday, pursuant to the laws of the State, the time for such performance shall be extended to 5:00 p.m. on the next business day.

3.7 Notices. Unless otherwise provided in this Agreement, all notices, demands and correspondence required or provided for under this Agreement shall be in writing and delivered in person or sent by overnight courier or mailed by certified mail postage prepaid, return receipt requested. Notices shall be addressed as follows:

To County: WASHOE COUNTY
Department of Community Development
Current Planning Division
PO Box 11130
Reno, NV 89520-0027

To Owner: Gene James Feickert, Jr. and Tara Ruth Feickert
1209 Mallard Crest Drive
Sparks, NV 89441

3.8 Written Amendments. Amendments to this Agreement shall be defined as changes which are not in substantial compliance with this Agreement. Amendments, if any, shall be approved as provide in NRS 278.0205. Changes hereto which are in substantial compliance with this Agreement may be requested by Landowner and approved or denied by the Director of Planning and Building. The Director of Planning and Building shall also decide whether or not a proposed change is in substantial compliance with this Agreement or any forthcoming tentative maps. The Landowner may appeal an adverse decision by the Director of Planning and Building to the Board of County Commissioners by written notice filed with the Director of Planning and Building, if filed within thirty (30) days of receipt

of the notice of the adverse decision unless an appeal to the Board of Adjustment is required to occur first. No oral statements or representations subsequent to the execution hereof by either party are binding on the other party, and neither party shall have the right to rely on such oral statements or representations.

3.9 Future Cooperation. Each party shall, at the request of the other, at any time, execute and deliver to the requesting party all such further instruments as may be reasonably necessary or appropriate in order to effectuate the purpose and intent of this Agreement.

3.10 Third Party Beneficiary Rights. This Agreement is not intended to create any third-party beneficiary rights in any person not a party hereto.

3.11 Interpretation. The parties hereby acknowledge and agree that each has been given the opportunity to review this Agreement with legal counsel independently. The parties have equal bargaining power and intend the plain meaning of the provisions herein. In the event of an ambiguity in or dispute regarding the interpretation of the Agreement, the interpretation of this Agreement shall not be resolved by any rule of interpretation providing for interpretation against the party who causes the uncertainty to exist, or against the draftsmen.

3.12 Counterparts. This instrument may be executed in two or more counterparts, which when taken together, shall constitute one and the same instrument. Any signature page of this instrument may be detached from any counterpart without impairing the legal effect of any signatures thereon, and may be attached to another counterpart identical in form thereto, but having attached to it one or more additional pages.

[Signatures appear on following page]

IN WITNESS WHEREOF, the parties hereto have executed this Agreement as of the Date above last written below.

LANDOWNER:

COUNTY:

Gene James Feickert, Jr.

**COUNTY OF WASHOE, a political
subdivision of the State of Nevada, BY
ITS BOARD OF WASHOE COUNTY
COMMISSIONERS**

By: _____

By: _____

Date: _____

Date: _____

Name: Gene James Feickert, Jr.

Name: Vaughn Hartung

Title: Signing Individually

Title: County Commission Chair

Tara Ruth Feickert

ATTEST:

By: _____

Jan Galassini, County Clerk

Date: _____

Name: Tara Ruth Feickert

Title: Signing Individually

[Signature page to Development Agreement]

STATE OF NEVADA)
) SS.
COUNTY OF WASHOE)

This instrument was acknowledged before me on _____,
2022, by Gene James Feickert, Jr.

My Commission Expires: _____

STATE OF NEVADA)
) SS.
COUNTY OF WASHOE)

This instrument was acknowledged before me on _____,
2022, by Tara Ruth Feickert.

My Commission Expires: _____

STATE OF NEVADA)
) SS.
COUNTY OF WASHOE)

This instrument was acknowledged before me on _____,
2021, by Vaughn Hartung, Chairman of the Washoe County Commissioners

My Commission Expires: _____

[Rough Plot Map]

EXHIBIT "A"

LEGAL DESCRIPTION OF SUBJECT PROPERTY

All that portion of Parcel 3-2-1-4 as shown on the Record of Survey Map No. 1010, filed in the office of the Washoe County Recorder, Washoe County, Nevada, on November 10, 1976 under File No. 434699 and Division of Land Map No. 14, recorded November 10, 1976 under File No. 434701, more particularly described as follows:

A portion of Section 3, Township 22 North, Range 21 East, Mount Diablo Base and Meridian in the County of Washoe, State of Nevada, being more particularly described as follows:

Commencing at the Northwest corner of Section 3;

thence South $01^{\circ}16'23''$ West, 2,625.44 feet; thence South $88^{\circ}42'24''$ East, 1,825.16 feet to the TRUE POINT OF BEGINNING; thence South $88^{\circ}42'24''$ East, 813.40 feet; thence South $01^{\circ}03'12''$ West, 1,327.56 feet; thence North $88^{\circ}43'10''$ West, 1,681.16 feet to the centerline intersection of Whiskey Springs Road Easement, 66.00 feet in width as shown on the Record of Survey Map File No. 434699 of Official Records of Washoe County; thence along said centerline North $44^{\circ}31'11''$ West, 135.63 feet; thence departing from said centerline North $39^{\circ}10'22''$ East, 1,562.63 feet to the TRUE POINT OF BEGINNING.

The above legal description was taken from prior Document No. 5251249.
Assessor's Parcel No.: 077-560-05

Exhibit A

EXHIBIT "B"

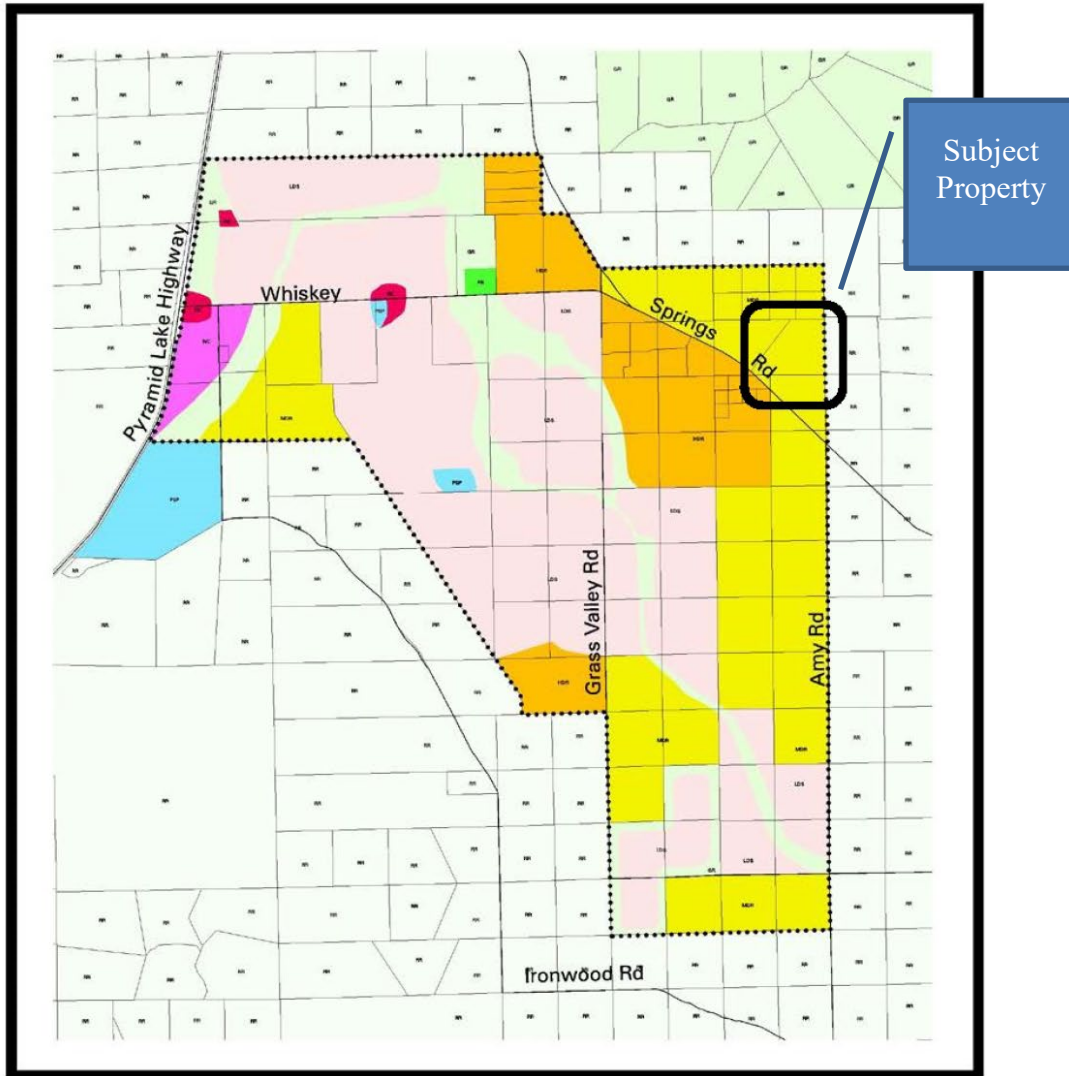

WARM SPRINGS SPECIFIC PLAN LAND USE PLAN

<ul style="list-style-type: none"> LOW DENSITY RURAL MEDIUM DENSITY RURAL HIGH DENSITY RURAL LOW DENSITY SUBURBAN MEDIUM DENSITY SUBURBAN HIGH DENSITY SUBURBAN 	<ul style="list-style-type: none"> LOW DENSITY URBAN MEDIUM DENSITY URBAN HIGH DENSITY URBAN GENERAL COMMERCIAL NEIGHBORHOOD COMMERCIAL/ OFFICE TOURIST COMMERCIAL 	<ul style="list-style-type: none"> INDUSTRIAL PUBLIC AND SEMI-PUBLIC FACILITIES PARKS AND RECREATION OPEN SPACE RURAL RESIDENTIAL / GENERAL RURAL SPECIFIC PLAN
---	--	---

SOURCE: DEPARTMENT OF COMMUNITY DEVELOPMENT
g:\arcinfo\planarea\wss\spss\wsspe_plu00.gra

DATE: JULY 1995

NOTE: THE SCALE AND CONFIGURATION OF ALL INFORMATION
SHOWN HEREON ARE APPROXIMATE ONLY AND ARE NOT WARRANTED
ALL RIGHTS RESERVED. NO LIABILITY FOR REPRODUCTION IS
NOT PERMITTED WITHOUT PRIOR WRITTEN PERMISSION FROM
THE WASHOE COUNTY DEPARTMENT OF COMMUNITY DEVELOPMENT.
THE HORSESHOE YEAR FOR THIS PLAN IS 2015, ADOPTED BY
THE BOARD OF COUNTY COMMISSIONERS ON SEPTEMBER 22, 2015.

0 1000 2000
SCALE IN FEET

**Department of
Community
Development**

**WASHOE COUNTY
NEVADA**

POST OFFICE BOX 11130
RENO, NEVADA 89520
(775) 328-3600

[Rough Plot Map]

EXHIBIT "C"

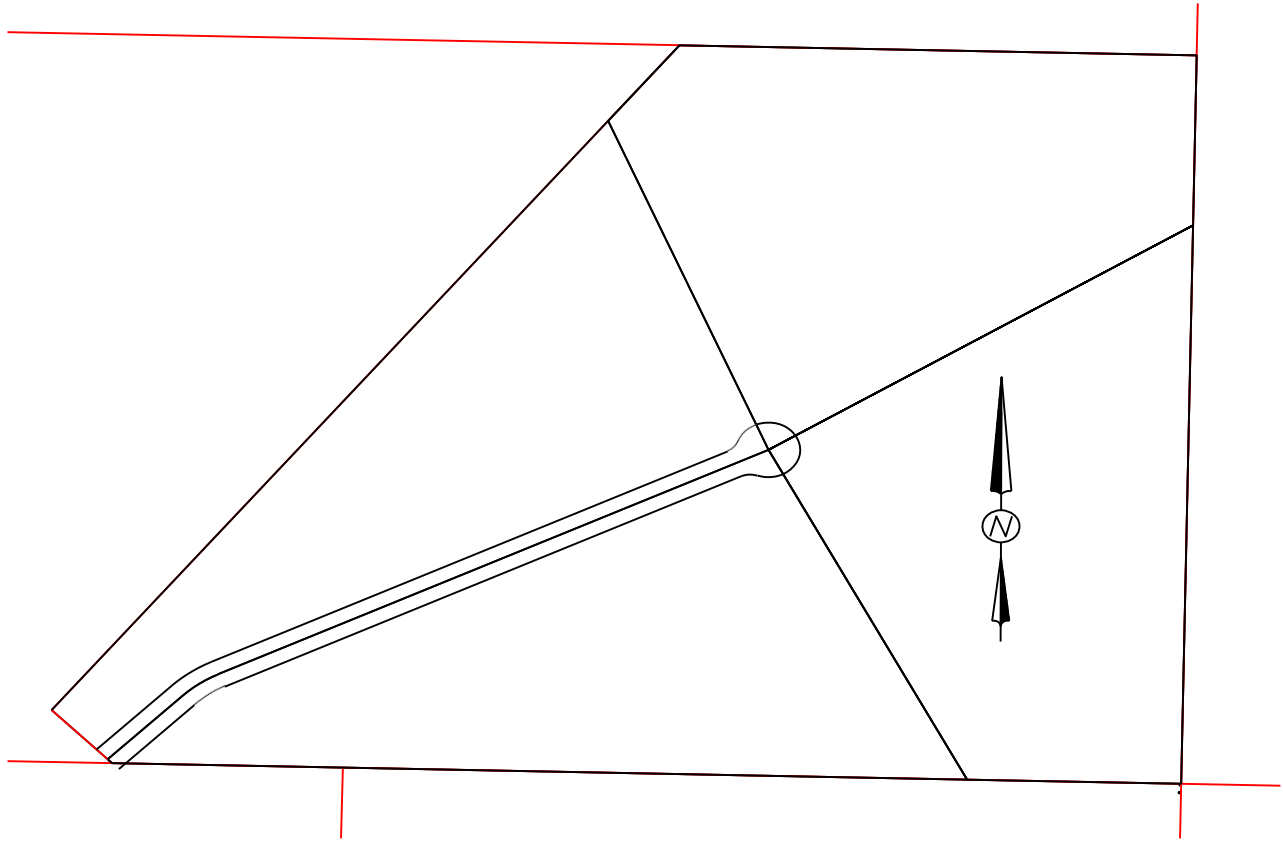

[Rough Plot Map]



First Centennial Title Company of Nevada

1450 Ridgeview Dr, Ste 100, Reno, NV 89519

Phone: (775)689-8510 • Fax:



COMMITMENT FOR TITLE INSURANCE

Today's Date:

June 6, 2022

Order No.: 21022899A-RT

Escrow Officer: Reno Title Only

Proposed Buyer/Borrower: Gene James Feickert, Jr. and Tara Ruth Feickert

Property Address: 5870 Whiskey Springs Road, Reno, NV 89510

Lender:

Loan Amount: \$0.00

First Centennial Title of Nevada

A handwritten signature in cursive script that reads "Anne Ambrose".

Anne Ambrose, Authorized Signatory



COMMITMENT FOR TITLE INSURANCE

NOTICE

IMPORTANT - READ CAREFULLY: THIS COMMITMENT IS AN OFFER TO ISSUE ONE OR MORE TITLE INSURANCE POLICIES. ALL CLAIMS OR REMEDIES SOUGHT AGAINST THE COMPANY INVOLVING THE CONTENT OF THIS COMMITMENT OR THE POLICY MUST BE BASED SOLELY IN CONTRACT.

THIS COMMITMENT IS NOT AN ABSTRACT OF TITLE, REPORT OF THE CONDITION OF TITLE, LEGAL OPINION, OPINION OF TITLE, OR OTHER REPRESENTATION OF THE STATUS OF TITLE. THE PROCEDURES USED BY THE COMPANY TO DETERMINE INSURABILITY OF THE TITLE, INCLUDING ANY SEARCH AND EXAMINATION, ARE PROPRIETARY TO THE COMPANY, WERE PERFORMED SOLELY FOR THE BENEFIT OF THE COMPANY, AND CREATE NO EXTRACONTRACTUAL LIABILITY TO ANY PERSON, INCLUDING A PROPOSED INSURED.

THE COMPANY'S OBLIGATION UNDER THIS COMMITMENT IS TO ISSUE A POLICY TO A PROPOSED INSURED IDENTIFIED IN SCHEDULE A IN ACCORDANCE WITH THE TERMS AND PROVISIONS OF THIS COMMITMENT. THE COMPANY HAS NO LIABILITY OR OBLIGATION INVOLVING THE CONTENT OF THIS COMMITMENT TO ANY OTHER PERSON.

COMMITMENT TO ISSUE POLICY

Subject to the Notice; Schedule B, Part I - Requirements; Schedule B, Part II - Exceptions; and the Commitment Conditions, Real Advantage Title Insurance Company, a(n) California corporation (the "Company"), commits to issue the Policy according to the terms and provisions of this Commitment. This Commitment is effective as of the Commitment Date shown in Schedule A for each Policy described in Schedule A, only when the Company has entered in Schedule A both the specified dollar amount as the Proposed Policy Amount and the name of the Proposed Insured.

If all of the Schedule B, Part I - Requirements have not been met within n/a after the Commitment Date, this Commitment terminates and the Company's liability and obligation end.

COMMITMENT CONDITIONS

1. DEFINITIONS

- (a) "Knowledge" or "Known": Actual or imputed knowledge, but not constructive notice imparted by the Public Records.
- (b) "Land": The land described in Schedule A and affixed improvements that by law constitute real property. The term "Land" does not include any property beyond the lines of the area described in Schedule A, nor any right, title, interest, estate, or easement in abutting streets, roads, avenues, alleys, lanes, ways, or waterways, but this does not modify or limit the extent that a right of access to and from the Land is to be insured by the Policy.

This page is only a part of a 2016 ALTA® Commitment for Title Insurance issued by Real Advantage Title Insurance Company. This Commitment is not valid without the Notice; the Commitment to Issue Policy; the Commitment Conditions; Schedule A; Schedule B, Part I - Requirements; and Schedule B, Part II - Exceptions; and a counter-signature by the Company or its issuing agent that may be in electronic form.

Copyright 2006 - 2016 American Land Title Association. All rights reserved.

The use of this Form (or any derivative thereof) is restricted to ALTA licensees and ALTA members in good standing as of the date of use. All other uses are prohibited. Reprinted under license from the American Land Title Association.



- (c) "Mortgage": A mortgage, deed of trust, or other security instrument, including one evidenced by electronic means authorized by law.
 - (d) "Policy": Each contract of title insurance, in a form adopted by the American Land Title Association, issued or to be issued by the Company pursuant to this Commitment.
 - (e) "Proposed Insured": Each person identified in Schedule A as the Proposed Insured of each Policy to be issued pursuant to this Commitment.
 - (f) "Proposed Policy Amount": Each dollar amount specified in Schedule A as the Proposed Policy Amount of each Policy to be issued pursuant to this Commitment.
 - (g) "Public Records": Records established under state statutes at the Commitment Date for the purpose of imparting constructive notice of matters relating to real property to purchasers for value and without Knowledge.
 - (h) "Title": The estate or interest described in Schedule A.
2. If all of the Schedule B, Part I - Requirements have not been met within the time period specified in the Commitment to Issue Policy, this Commitment terminates and the Company's liability and obligation end.
3. The Company's liability and obligation is limited by and this Commitment is not valid without:
- (a) the Notice;
 - (b) the Commitment to Issue Policy;
 - (c) the Commitment Conditions;
 - (d) Schedule A;
 - (e) Schedule B, Part I—Requirements; [and]
 - (f) Schedule B, Part II—Exceptions[; and
 - (g) a counter-signature by the Company or its issuing agent that may be in electronic form].

4. COMPANY'S RIGHT TO AMEND

The Company may amend this Commitment at any time. If the Company amends this Commitment to add a defect, lien, encumbrance, adverse claim, or other matter recorded in the Public Records prior to the Commitment Date, any liability of the Company is limited by Commitment Condition 5. The Company shall not be liable for any other amendment to this Commitment.

5. LIMITATIONS OF LIABILITY

- (a) The Company's liability under Commitment Condition 4 is limited to the Proposed Insured's actual expense incurred in the interval between the Company's delivery to the Proposed Insured of the Commitment and the delivery of the amended Commitment, resulting from the Proposed Insured's good faith reliance to:
 - (i) comply with the Schedule B, Part I - Requirements;
 - (ii) eliminate, with the Company's written consent, any Schedule B, Part II - Exceptions; or
 - (iii) acquire the Title or create the Mortgage covered by this Commitment.
- (b) The Company shall not be liable under Commitment Condition 5(a) if the Proposed Insured requested the amendment or had Knowledge of the matter and did not notify the Company about it in writing.
- (c) The Company will only have liability under Commitment Condition 4 if the Proposed Insured would not have incurred the expense had the Commitment included the added matter when the Commitment was first delivered to the Proposed Insured.
- (d) The Company's liability shall not exceed the lesser of the Proposed Insured's actual expense incurred in good faith and described in Commitment Conditions 5(a)(i) through 5(a)(iii) or the Proposed Policy Amount.
- (e) The Company shall not be liable for the content of the Transaction Identification Data, if any.
- (f) In no event shall the Company be obligated to issue the Policy referred to in this Commitment unless all of the Schedule B, Part I - Requirements have been met to the satisfaction of the Company.
- (g) In any event, the Company's liability is limited by the terms and provisions of the Policy.

This page is only a part of a 2016 ALTA® Commitment for Title Insurance issued by Real Advantage Title Insurance Company. This Commitment is not valid without the Notice; the Commitment to Issue Policy; the Commitment Conditions; Schedule A; Schedule B, Part I - Requirements; and Schedule B, Part II - Exceptions; and a counter-signature by the Company or its issuing agent that may be in electronic form.

Copyright 2006 - 2016 American Land Title Association. All rights reserved.

The use of this Form (or any derivative thereof) is restricted to ALTA licensees and ALTA members in good standing as of the date of use. All other uses are prohibited. Reprinted under license from the American Land Title Association.



6. LIABILITY OF THE COMPANY MUST BE BASED ON THIS COMMITMENT

- (a) Only a Proposed Insured identified in Schedule A, and no other person, may make a claim under this Commitment.
- (b) Any claim must be based in contract and must be restricted solely to the terms and provisions of this Commitment.
- (c) Until the Policy is issued, this Commitment, as last revised, is the exclusive and entire agreement between the parties with respect to the subject matter of this Commitment and supersedes all prior commitment negotiations, representations, and proposals of any kind, whether written or oral, express or implied, relating to the subject matter of this Commitment.
- (d) The deletion or modification of any Schedule B, Part II - Exception does not constitute an agreement or obligation to provide coverage beyond the terms and provisions of this Commitment or the Policy.
- (e) Any amendment or endorsement to this Commitment must be in writing [and authenticated by a person authorized by the Company].
- (f) When the Policy is issued, all liability and obligation under this Commitment will end and the Company's only liability will be under the Policy.

7. IF THIS COMMITMENT HAS BEEN ISSUED BY AN ISSUING AGENT

The issuing agent is the Company's agent only for the limited purpose of issuing title insurance commitments and policies. The issuing agent is not the Company's agent for the purpose of providing closing or settlement services.

8. PRO-FORMA POLICY

The Company may provide, at the request of a Proposed Insured, a pro-forma policy illustrating the coverage that the Company may provide. A pro-forma policy neither reflects the status of Title at the time that the pro-forma policy is delivered to a Proposed Insured, nor is it a commitment to insure.

This page is only a part of a 2016 ALTA® Commitment for Title Insurance issued by Real Advantage Title Insurance Company. This Commitment is not valid without the Notice; the Commitment to Issue Policy; the Commitment Conditions; Schedule A; Schedule B, Part I - Requirements; and Schedule B, Part II - Exceptions; and a counter-signature by the Company or its issuing agent that may be in electronic form.

Copyright 2006 - 2016 American Land Title Association. All rights reserved.

The use of this Form (or any derivative thereof) is restricted to ALTA licensees and ALTA members in good standing as of the date of use. All other uses are prohibited. Reprinted under license from the American Land Title Association.





COMMITMENT FOR TITLE INSURANCE

Transaction Identification Data for reference only:

Issuing Agent: First Centennial Title Company of Nevada
Issuing Office: 1450 Ridgeview Dr, Ste 100, Reno, NV 89519
Issuing Office's ALTA® Registry ID: 1022833
Loan ID No.:
Commitment No.: 21022899A-RT-1
Issuing Office File No.: 21022899A-RT
Property Address: 5870 Whiskey Springs Road, Reno, NV 89510

SCHEDULE A

1. Commitment Date: May 25, 2022 at 08:00 AM
2. Policy to be issued:
 - a. ALTA Owners Policy (06/17/06)
Proposed Insured: Gene James Feickert, Jr. and Tara Ruth Feickert
Proposed Policy Amount: \$0.00
 - b.
Proposed Insured:
Proposed Policy Amount: \$0.00
3. The estate or interest in the Land described or referred to in this Commitment is Fee Simple.
4. The Title is, at the Commitment Date, vested in:

Gene James Feickert, Jr. and Tara Ruth Feickert, husband and wife, as joint tenants with right of survivorship
5. The Land is described as follows:

SEE SCHEDULE C ATTACHED HERETO

This page is only a part of a 2016 ALTA® Commitment for Title Insurance issued by Real Advantage Title Insurance Company. This Commitment is not valid without the Notice; the Commitment to Issue Policy; the Commitment Conditions; Schedule A; Schedule B, Part I - Requirements; and Schedule B, Part II - Exceptions; and a counter-signature by the Company or its issuing agent that may be in electronic form.

Copyright 2006 - 2016 American Land Title Association. All rights reserved.

The use of this Form (or any derivative thereof) is restricted to ALTA licensees and ALTA members in good standing as of the date of use. All other uses are prohibited. Reprinted under license from the American Land Title Association.



SCHEDULE A
(Continued)

First Centennial Title of Nevada



Anne Ambrose, Authorized Signatory

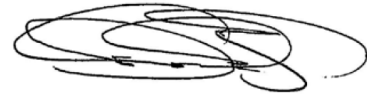

By: John Wiley, Executive Vice President

This page is only a part of a 2016 ALTA® Commitment for Title Insurance issued by Real Advantage Title Insurance Company. This Commitment is not valid without the Notice; the Commitment to Issue Policy; the Commitment Conditions; Schedule A; Schedule B, Part I - Requirements; and Schedule B, Part II - Exceptions; and a counter-signature by the Company or its issuing agent that may be in electronic form.

Copyright 2006 - 2016 American Land Title Association. All rights reserved.

The use of this Form (or any derivative thereof) is restricted to ALTA licensees and ALTA members in good standing as of the date of use. All other uses are prohibited. Reprinted under license from the American Land Title Association.





COMMITMENT FOR TITLE INSURANCE

SCHEDULE B, PART I Requirements

All of the following Requirements must be met:

1. The Proposed Insured must notify the Company in writing of the name of any party not referred to in this Commitment who will obtain an interest in the Land or who will make a loan on the Land. The Company may then make additional Requirements or Exceptions.
2. Pay the agreed amount for the estate or interest to be insured.
3. Pay the premiums, fees, and charges for the Policy to the Company.
4. Documents satisfactory to the Company that convey the Title or create the Mortgage to be insured, or both, must be properly authorized, executed, delivered, and recorded in the Public Records.
5. Any rights, interest or claim of parties in possession of the land not disclosed by the public records. A Rent Roll / List of Lessees will be required prior to the close of escrow.
6. The requirement that an Owner's Declaration/Affidavit be completed and supplied for review prior to the issuance of any policy of title insurance.
7. Prior to the issuance of an ALTA Extended form policy of title insurance, an ALTA/NSPS Survey may be required.
8. An inspection will be required prior to the close of escrow. Please notify the Title Department 24 hours prior to closing.

This page is only a part of a 2016 ALTA® Commitment for Title Insurance issued by Real Advantage Title Insurance Company. This Commitment is not valid without the Notice; the Commitment to Issue Policy; the Commitment Conditions; Schedule A; Schedule B, Part I - Requirements; and Schedule B, Part II - Exceptions; and a counter-signature by the Company or its issuing agent that may be in electronic form.

Copyright 2006 - 2016 American Land Title Association. All rights reserved.

The use of this Form (or any derivative thereof) is restricted to ALTA licensees and ALTA members in good standing as of the date of use. All other uses are prohibited. Reprinted under license from the American Land Title Association.



SCHEDULE B

(Continued)

NOTE:

If this Report is issued in contemplation of a Policy of Title Insurance which affords mechanics lien priority coverage (i.e. ALTA Policy); the following information must be supplied for review and approval prior to the closing and issuance of said Policy:

- a. Signed Indemnity Agreement
- b. Financial Statements
- c. Construction Loan Agreement
- d. Building Construction Contract between borrower and contractor
- e. Cost breakdown of construction
- f. Appraisal
- g. Copy of Voucher or Disbursement Control Statement (if project is complete)
- h. Copies of Waivers and/or Lien Releases from any party that supplied work or materials.

NOTE:

A property inspection will be made prior to recording the Deed of Trust to be insured. If such inspection discloses any evidence of commencement of a work of improvement, the coverage for mechanic's lien insurance will be deleted from the policy, unless all the necessary documents for indemnification have been submitted to the Company, and such indemnification has been formally approved by the Company, and its Underwriter, prior to the close of escrow.

NOTE:

If the intended transaction involves a Construction Loan wherein the Proposed Lender is requesting ALTA Extended Coverage, including Mechanic's Lien Coverage, the ALTA 32 and ALTA 33 Endorsement procedure will be required to be approved for use by the Lender.

NOTE:

Pending disbursement of the loan secured by the mortgage described herein, the Company insures only to the extent of the amount actually disbursed but increases as each disbursement is made in good faith and without knowledge of any defects in, or objections to the title, up to the face amount of the policy. Notwithstanding anything contained herein to the contrary, this policy does not guarantee the completion of the improvements, nor the sufficiency of funds for the completion thereof.

NOTE: General and Special Taxes for proration purposes for the fiscal year 2021-2022 including any secured personal property and any district assessments, are PAID IN FULL.

Total Amount Taxed: \$1,409.10
Credit: \$688.21
Total Amount Paid: \$720.89
Assessor's Parcel No.: 077-560-05

Please contact the Washoe County Treasurer's Office at (775) 328-2510 to obtain current amounts due prior to the close of escrow.

This page is only a part of a 2016 ALTA® Commitment for Title Insurance issued by Real Advantage Title Insurance Company. This Commitment is not valid without the Notice; the Commitment to Issue Policy; the Commitment Conditions; Schedule A; Schedule B, Part I - Requirements; and Schedule B, Part II - Exceptions; and a counter-signature by the Company or its issuing agent that may be in electronic form.

Copyright 2006 - 2016 American Land Title Association. All rights reserved.

The use of this Form (or any derivative thereof) is restricted to ALTA licensees and ALTA members in good standing as of the date of use. All other uses are prohibited. Reprinted under license from the American Land Title Association.



SCHEDULE B

(Continued)

NOTE:

According to the public records there have been no conveyances of the property described in this Report within a period of 24] months prior to the date of this Report, except as follows:

A Grant, Bargain, Sale Deed, dated 11/19/2021, recorded 11/23/2021, as Document No. 5251249, Official Records, Washoe County, Nevada.

Grantor: Essex Group, LLC, a Florida Limited Liability Company

Grantee: Gene James Feickert, Jr. and Tara Ruth Feickert, husband and wife,
as joint tenants with right of survivorship

NOTE: This report is preparatory to the issuance of a Policy of Title Insurance, in the amount of land only, no Endorsement will be issued.

Property Address: 5870 Whiskey Springs Road, Reno, NV.

NOTE: This is to give you notice that Orange Coast Title Company owns a membership interest in First Centennial Title Company and Orange Coast Title Company also owns Real Advantage Title Insurance Company. This underwriter may be chosen by First Centennial Title Company and this referral may provide Orange Coast Title Company a financial or other benefit.

You are NOT required to use the listed provider as a condition for settlement of your loan or purchase, sale or refinance of the subject property and you have the opportunity to select any of the First Centennial Title Company title insurance underwriters for your transaction. THERE ARE FREQUENTLY OTHER SETTLEMENT SERVICE PROVIDERS AVAILABLE WITH SIMILAR SERVICES. YOU ARE FREE TO SHOP AROUND TO DETERMINE THAT YOU ARE RECEIVING THE BEST SERVICES AND THE BEST RATE FOR THESE SERVICES.

NOTE: FIRST CENTENNIAL TITLE COMPANY OF NEVADA RESERVES THE RIGHT TO AMEND THIS REPORT AND TO REQUEST FURTHER REQUIREMENTS, AFTER REVIEW OF THE REQUESTED DOCUMENTATION, AT ANY TIME PRIOR TO THE CLOSE OF THE TRANSACTION.

This page is only a part of a 2016 ALTA® Commitment for Title Insurance issued by Real Advantage Title Insurance Company. This Commitment is not valid without the Notice; the Commitment to Issue Policy; the Commitment Conditions; Schedule A; Schedule B, Part I - Requirements; and Schedule B, Part II - Exceptions; and a counter-signature by the Company or its issuing agent that may be in electronic form.

Copyright 2006 - 2016 American Land Title Association. All rights reserved.

The use of this Form (or any derivative thereof) is restricted to ALTA licensees and ALTA members in good standing as of the date of use. All other uses are prohibited. Reprinted under license from the American Land Title Association.



SCHEDULE B

(Continued)

SCHEDULE B, PART II

Exceptions

THIS COMMITMENT DOES NOT REPUBLISH ANY COVENANT, CONDITION, RESTRICTION, OR LIMITATION CONTAINED IN ANY DOCUMENT REFERRED TO IN THIS COMMITMENT TO THE EXTENT THAT THE SPECIFIC COVENANT, CONDITION, RESTRICTION, OR LIMITATION VIOLATES STATE OR FEDERAL LAW BASED ON RACE, COLOR, RELIGION, SEX, SEXUAL ORIENTATION, GENDER IDENTITY, HANDICAP, FAMILIAL STATUS, OR NATIONAL ORIGIN.

The Policy will not insure against loss or damage resulting from the terms and provisions of any lease or easement identified in Schedule A, and will include the following Exceptions unless cleared to the satisfaction of the Company:

1. Any defect, lien, encumbrance, adverse claim, or other matter that appears for the first time in the Public Records or is created, attaches, or is disclosed between the Commitment Date and the date on which all of the Schedule B, Part I - Requirements are met.
2. (a) Taxes or assessments which are not shown as existing liens by the records of any taxing authority that levies taxes or assessments on real property or by the Public Records.
(b) Proceedings by a public agency which may result in taxes or assessments, or notices of such proceedings, whether or not shown by the records of such agency or by the Public Records.
3. Any facts, rights, interests, or claims which are not shown by the Public Records but that could be ascertained by an inspection of the Land or which may be asserted by persons in possession of the Land.
4. Easements, liens or encumbrances, or claims thereof, not shown by the Public Records.
5. Any encroachment, encumbrance, violation, variation, or adverse circumstances affecting the Title that would be disclosed by an accurate and complete land survey of the Land and not shown by the Public Records.
6. (a) Unpatented mining claims; (b) reservations or exceptions in Patents or in Acts authorizing the issuance thereof; (c) water rights, or claims or title to water, whether or not the matters excepted under (a), (b) or (c) are shown by the Public Records.
7. Any lien or right to a lien for services, labor or material not shown by the Public Records.

Exceptions 1-7 will be omitted on extended coverage policies

8. General and Special Taxes for the fiscal year 2022-2023, including any secured personal property taxes and any district assessments, a lien, not yet due and payable.
Assessors Parcel No.: 077-560-05
9. Any additional tax that may be levied against said land due to the supplemental tax roll, by reason of a change in ownership or completion of new construction thereon.

This page is only a part of a 2016 ALTA® Commitment for Title Insurance issued by Real Advantage Title Insurance Company. This Commitment is not valid without the Notice; the Commitment to Issue Policy; the Commitment Conditions; Schedule A; Schedule B, Part I - Requirements; and Schedule B, Part II - Exceptions; and a counter-signature by the Company or its issuing agent that may be in electronic form.

Copyright 2006 - 2016 American Land Title Association. All rights reserved.

The use of this Form (or any derivative thereof) is restricted to ALTA licensees and ALTA members in good standing as of the date of use. All other uses are prohibited. Reprinted under license from the American Land Title Association.



SCHEDULE B

(Continued)

10. Except all water, claims or rights to water, in or under said land.
11. Any liens that may be created for Delinquent Sewer Charges by reason of said premises lying within the City of Reno/Sparks, the County of Washoe (Sewer). Contact the following for Sewer/Water, and/or Tax Assessment information: City of Reno Sewer at (775) 334-2095; City of Sparks Sewer at (775) 353-2360; County of Washoe Sewer at (775) 954-4601; Washoe County Treasurer at (775) 328-2510. Delinquent amounts may be added to and collected through the secured real property tax roll of the Washoe County Assessor's Office and included in the tax installments referenced above.

Any liens as created by the Central Truckee Meadows Remediation District, the Golden Valley Aquifer Recharge Program, or the North Spanish Springs Floodplain Detention Facility. Please fax demands to Washoe County Utilities at (775) 328-3699.

Any liens which may be or may become due the Sun Valley General Improvement District by reason of said land being within the boundaries of said District, and any use of the services provided thereby. Please contact the following number for specific amounts – (775)673-2220.

Any liens which may be or may become due the Incline Village General Improvement District by reason of said land being within the boundaries of said District, and any use of the services provided thereby. Please contact the following number for specific amounts – (775)832-1203.
12. Any unpaid charges for delinquent garbage fees, plus any interest and/or penalties, which would create a lien and attach to said premises, pursuant to Nevada Revised Statutes Section 444.520.
13. Easements, dedications, reservations, provisions, relinquishments, recitals, building set back lines, certificates, and any other matters as provided for or delineated on [Record of Survey Map No. 1010](#), recorded November 10, 1976, as Document No. 434699.
14. Easements, dedications, reservations, provisions, relinquishments, recitals, building set back lines, certificates, and any other matters as provided for or delineated on [Division of Land Map No. 14](#), recorded November 10, 1976, as Document No. 434701.
15. An easement as granted to Palomino Valley General Improvement District, for roadway, public utilities, and incidental purposes, as set forth in an instrument recorded 11/12/1976, in Book 1024, Page 191, as [Document No. 434927](#), Official Records.
16. An easement as granted to Sierra Pacific Power Company and Bell Telephone Company of Nevada, to construct, operate and maintain electric power and communication lines and incidental purposes, by instrument recorded 01/05/1978, in Book 1179, Page 166, as [Document No. 507264](#), Official Records, 10 feet in width, along and adjacent to all parcel lines excepting only those parcel lines within roadway easements.
17. The terms, covenants, conditions and provisions as contained in an instrument, entitled "Development Agreement", recorded October 12, 2007, as [Document No. 3584016](#), of Official Records.

This page is only a part of a 2016 ALTA® Commitment for Title Insurance issued by Real Advantage Title Insurance Company. This Commitment is not valid without the Notice; the Commitment to Issue Policy; the Commitment Conditions; Schedule A; Schedule B, Part I - Requirements; and Schedule B, Part II - Exceptions; and a counter-signature by the Company or its issuing agent that may be in electronic form.

Copyright 2006 - 2016 American Land Title Association. All rights reserved.

The use of this Form (or any derivative thereof) is restricted to ALTA licensees and ALTA members in good standing as of the date of use. All other uses are prohibited. Reprinted under license from the American Land Title Association.





COMMITMENT FOR TITLE INSURANCE

SCHEDULE C

The Land is described as follows:

All that portion of Parcel 3-2-1-4 as shown on the Record of Survey Map No. 1010, filed in the office of the Washoe County Recorder, Washoe County, Nevada, on November 10, 1976 under File No. 434699 and Division of Land Map No. 14, recorded November 10, 1976 under File No. 434701, more particularly described as follows:

A portion of Section 3, Township 22 North, Range 21 East, Mount Diablo Base and Meridian in the County of Washoe, State of Nevada, being more particularly described as follows:

Commencing at the Northwest corner of Section 3;

thence South 01°16'23" West, 2,625.44 feet; thence South 88°42'24" East, 1,825.16 feet to the TRUE POINT OF BEGINNING; thence South 88°42'24" East, 813.40 feet; thence South 01°03'12" West, 1,327.56 feet; thence North 88°43'10" West, 1,681.16 feet to the centerline intersection of Whiskey Springs Road Easement, 66.00 feet in width as shown on the Record of Survey Map File No. 434699 of Official Records of Washoe County; thence along said centerline North 44°31'11" West, 135.63 feet; thence departing from said centerline North 39°10'22" East, 1,562.63 feet to the TRUE POINT OF BEGINNING.

The above legal description was taken from prior Document No. 2979631.

Assessors Parcel No.: 077-560-05

This page is only a part of a 2016 ALTA® Commitment for Title Insurance issued by Real Advantage Title Insurance Company. This Commitment is not valid without the Notice; the Commitment to Issue Policy; the Commitment Conditions; Schedule A; Schedule B, Part I - Requirements; and Schedule B, Part II - Exceptions; and a counter-signature by the Company or its issuing agent that may be in electronic form.

Copyright 2006 - 2016 American Land Title Association. All rights reserved.

The use of this Form (or any derivative thereof) is restricted to ALTA licensees and ALTA members in good standing as of the date of use. All other uses are prohibited. Reprinted under license from the American Land Title Association.



JLM TITLE, LLC, a Nevada Limited Liability Company, dba FIRST CENTENNIAL TITLE COMPANY
PRIVACY POLICY

Re: 5870 Whiskey Springs Road, Reno, NV 89510

We Are Committed to Safeguarding Customer Information

In order to better serve your needs now and in the future, we may ask you to provide us with certain information. We understand that you may be concerned about what we will do with such information – particularly any personal or financial information. We agree that you have a right to know how we will utilize the personal information that you provide to us. Therefore, we have adopted this Privacy Policy to govern the use and handling of your personal information.

Applicability

This Privacy Policy governs our use of the information which you provide to us. It does not govern the manner in which we may use information we have obtained from any other source, such as information obtained from a public record or from another person or entity.

Types of Information

Depending upon which of our services you are utilizing, the types of nonpublic personal information that we may collect include:

- Information we receive from you on applications, forms and in other communications to us, whether in writing, in person, by telephone or any other means.
- Information we receive from providers of services to us, such as appraisers, appraisal management companies, real estate agents and brokers and insurance agencies (this may include the appraised value, purchase price and other details about the property that is the subject of your transaction with us).
- Information about your transactions with us, our Affiliated Companies, or others; and
- Information we receive from a consumer reporting agency.

Use of Information

We request information from you for our own legitimate business purposes and not for benefit of any nonaffiliated party. Therefore, we will not release your information to nonaffiliated parties except: (1) as necessary for us to provide the product or service you have requested of us; or (2) as permitted by law. We may, however, store such information indefinitely, including the period after which any customer relationship has ceased. Such information may be used for any internal purpose, such as quality control efforts or customer analysis.

Former Customers

Even if you are no longer our customer, our Privacy Policy will continue to apply to you.

Confidentiality and Security

We will use our best efforts to ensure that no unauthorized parties have access to any of your information. We restrict access to nonpublic personal information about you to those individuals and entities who need to know that information to provide products or services to you. We will use our best efforts to train and oversee our employees and agents to ensure that your information will be handled responsibly and in accordance with this Privacy Policy. We currently maintain physical, electronic, and procedural safeguards that comply with federal regulations to guard your nonpublic personal information.

Other Important Information

We reserve the right to modify or supplement this Privacy Policy at any time. If our Privacy Policy changes, we will provide the new Privacy Policy and the ability to opt out (as required by law) before the new policy becomes effective.

INITIALS

STATE OF NEVADA
WASHOE COUNTY
ASSESSOR'S OFFICE
Joshua G. Wilson, Assessor
1001 East North Street
Reno, Nevada 89512
(775) 328-2231



Feet:
0 75 150 225 300
1 inch = 300 feet

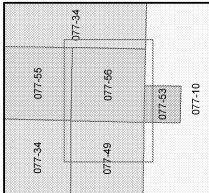
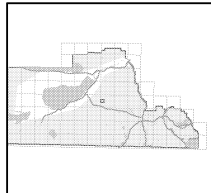

created by: CFB 02/10/2011
last updated:

area previously shown on map(s)

NOTE: This map was prepared for the use of the Washoe County Assessor for assessment and illustrative purposes only. It does not represent a survey of the premises. No liability is assumed for any error or inaccuracy of the data administered hereon.

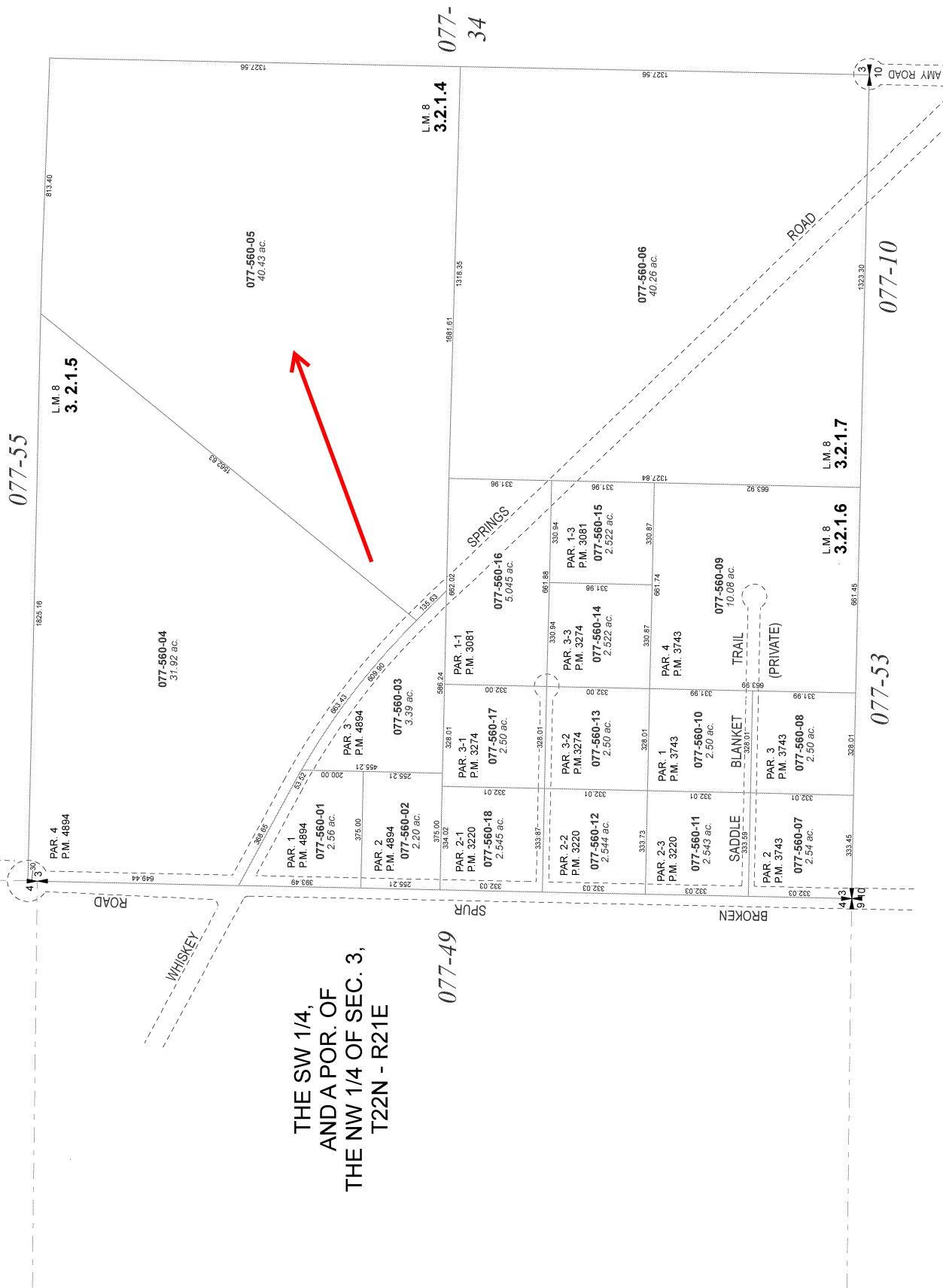

THE SW 1/4,
AND A POR. OF
THE NW 1/4 OF SEC. 3,
T22N - R21E

DOC # 5291398

04/04/2022 12:35:05 PM

Requested By
GENE FEICHERT

Washoe County Recorder

Kalie M. Work - Recorder

Fee: \$43.00 RPTT: \$246.00

Page 1 of 3

The undersigned hereby affirms that there is no Social Security number contained in this document

NO APN – Water Rights Only

RECORDING REQUESTED BY:

Gene James Feickert, Jr and Tara Ruth
1209 Mallard Crest Dr
Sparks, NV 89441

AFTER RECORDATION RETURN TO:

Gene James Feickert, Jr and Tara Ruth
1209 Mallard Crest Dr
Sparks, NV 89441

SPACE ABOVE THIS LINE FOR RECORDER'S USE

WATER RIGHTS GRANT, BARGAIN AND SALE DEED

THIS WATER RIGHTS GRANT, BARGAIN AND SALE DEED is made and entered into this 17th day of March, 2022, to convey the below-mentioned water rights from **Philip E. Condon and Heather C. Condon** (hereinafter referred to as "GRANTOR") to **Gene James Feickert, Jr. and Tara Ruth Feickert, husband and wife, as joint tenants with right of survivorship** (hereinafter referred to as "GRANTEE").

WITNESSETH:

That said GRANTOR, for good and valuable consideration, the receipt of which is hereby acknowledged, does hereby grant, bargain, sell, and convey to the GRANTEE, and to their successors, heirs, and assigns forever, all of GRANTOR's right, title, and interest in and to those certain waters and water rights situate in Washoe County, State of Nevada, as described as follows, to wit:

WATER RIGHTS:

NDWR Permit No. 77496 / Certificate No. 19204, 0.0714 c.f.s., 10.0 acre feet annually

TOGETHER WITH all and singular the tenements, hereditaments, and appurtenances thereunto belonging or in anywise appertaining, and any reversions, remainders, rents, issues or profits thereof.

TO HAVE AND TO HOLD, all and singular, the said water rights and the appurtenances, unto the said GRANTEE, and to their successors and assigns forever.

IN WITNESS WHEREOF the GRANTOR has hereunto executed this WATER RIGHTS GRANT, BARGAIN AND SALE DEED the day and year first written above.

DATED this 17th day of MARCH, 2022.

GRANTOR:



Philip E. Condon



Heather C. Condon

STATE OF Idaho)
 : ss.
COUNTY OF Washington)

On this 17th day of March, 2022, before me, the undersigned, a Notary Public in and for said state, personally appeared PHILIP E. CONDON personally known or proved to me to be the person whose name is subscribed to the within instrument and acknowledged to me that he executed the same in his authorized capacity, and that by his signature on the instrument the entity upon behalf of which the person acted, executed the instrument.

WITNESS my hand and official seal.

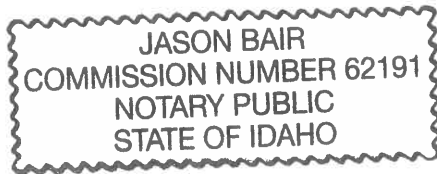



NOTARY PUBLIC
Commission expires 08/28/25

STATE OF Idaho)
 : ss.
COUNTY OF Washington)

On this 17th day of March, 2022, before me, the undersigned, a Notary Public in and for said state, personally appeared HEATHER C. CONDON personally known or proved to me to be the person whose name is subscribed to the within instrument and acknowledged to me that she executed the same in her authorized capacity, and that by her signature on the instrument the entity upon behalf of which the person acted, executed the instrument.

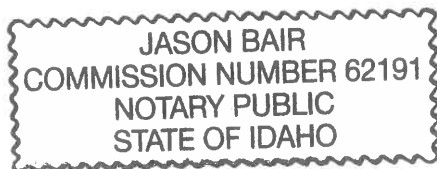
WITNESS my hand and official seal.



NOTARY PUBLIC
Commission expires: 08/28/25

PURCHASE AGREEMENT FOR WATER RIGHTS

We, Philip E. Condon and Heather C. Condon, agree to sell 10.00 acre feet of Warm Springs Valley (Basin 084) groundwater rights under Permit No. 77496 to Gene James Feickert, Jr and Tara Ruth Feickert, Husband and Wife for a purchase price of \$60,000.00 (Sixty-Thousand Dollars).

Buyer shall be responsible for all recording and filing fees to transfer all water rights.

Seller: Philip E. Condon

Signed:  Date: 3/22/2022

Seller: Heather C. Condon

Signed:  Date: 3/22/2022

Buyer: Gene James Feickert, Jr

Signed:  Date: 4/4/22

Buyer: Tara Ruth Feickert

Signed:  Date: 4/4/22

APN: 077-560-05
R.P.T.T.: \$1,230.00
Escrow No.: 21022899-CD
When Recorded Return To:
Gene James Feickert, Jr. and Tara Ruth
Feickert
1209 Mallard Crest Dr
Sparks, NV 89441

Mail Tax Statements to:
Gene James Feickert, Jr. and Tara Ruth
Feickert
1209 Mallard Crest Dr
Sparks, NV 89441

DOC #5251249

11/23/2021 10:57:45 AM
Electronic Recording Requested By
FIRST CENTENNIAL - RENO (MAIN OF
Washoe County Recorder
Kalie M. Work
Fee: \$43.00 RPTT: \$1230.00
Page 1 of 3

SPACE ABOVE FOR RECORDER'S USE

GRANT, BARGAIN, SALE DEED

FOR VALUABLE CONSIDERATION, receipt of which is hereby acknowledged,

Essex Group, LLC a Florida Limited Liability Company

do(es) hereby Grant, Bargain, Sell and Convey to

Gene James Feickert, Jr. and Tara Ruth Feickert, husband and wife, as joint tenants with right of survivorship

all that real property situated in the City of Reno, County of Washoe, State of Nevada, described as follows:

SEE LEGAL DESCRIPTION ATTACHED HERETO AND MADE A PART HEREOF AS EXHIBIT "A"

Together with all and singular tenements, hereditaments and appurtenances thereunto belonging or in anywise appertaining.

Page 2 of the Grant, Bargain, Sale Deed (signature page).

Escrow No.: 21022899-CD

Dated this 19 day of November, 2021.

Essex Group, LLC a Florida Limited Liability Company

BY: Gary Scott Merrill
Gary Scott Merrill
President

STATE OF ~~NEVADA~~ Florida

COUNTY OF Palm Beach

This instrument was acknowledged before me on this 19th day of November, 2021, by Gary Scott Merrill, as President of Essex Group, LLC a Florida Limited Liability Company.

[Signature]
Notary Public

