



Planning Commission Staff Report

Meeting Date: January 3, 2023

Agenda Item: 8C

SPECIAL USE PERMIT CASE NUMBER:	WSUP22-0035 (North Valley Solar)
BRIEF SUMMARY OF REQUEST:	Request for a special use permit to establish a 5.5 MW photo voltaic facility to support an approved adjacent geothermal facility and a special use permit for the associated grading with approximately 4.65 acres of disturbance.
STAFF PLANNER:	Kat Oakley, Planner Phone Number: 775.328.3628 E-mail: koakley@washoecounty.gov

CASE DESCRIPTION

For hearing, discussion, and possible action to approve a special use permit for: (a) energy production, renewable use type for a photovoltaic facility with a capacity of 5.5 MW, which surpasses the 5 MW threshold for a project of regional significance; and thus, will require conformance review by the Truckee Meadows Regional Planning Commission; (b) associated grading resulting in a disturbed area of 4.65 acres including 4,200 cubic yards of fill; and (c) requests to vary setbacks, landscaping, and parking requirements.

Applicant:	Orni 36, LLC
Property Owner:	Kosmos Company
Location:	Approximately 10 miles north of Pyramid Lake
APN:	071-070-12 & 071-070-13
Parcel Size:	163 acres & 160 acres
Master Plan:	Rural
Regulatory Zone:	General Rural
Area Plan:	High Desert
Development Code:	Authorized in Article 810, Special Use Permits
Commission District:	5 – Commissioner Herman

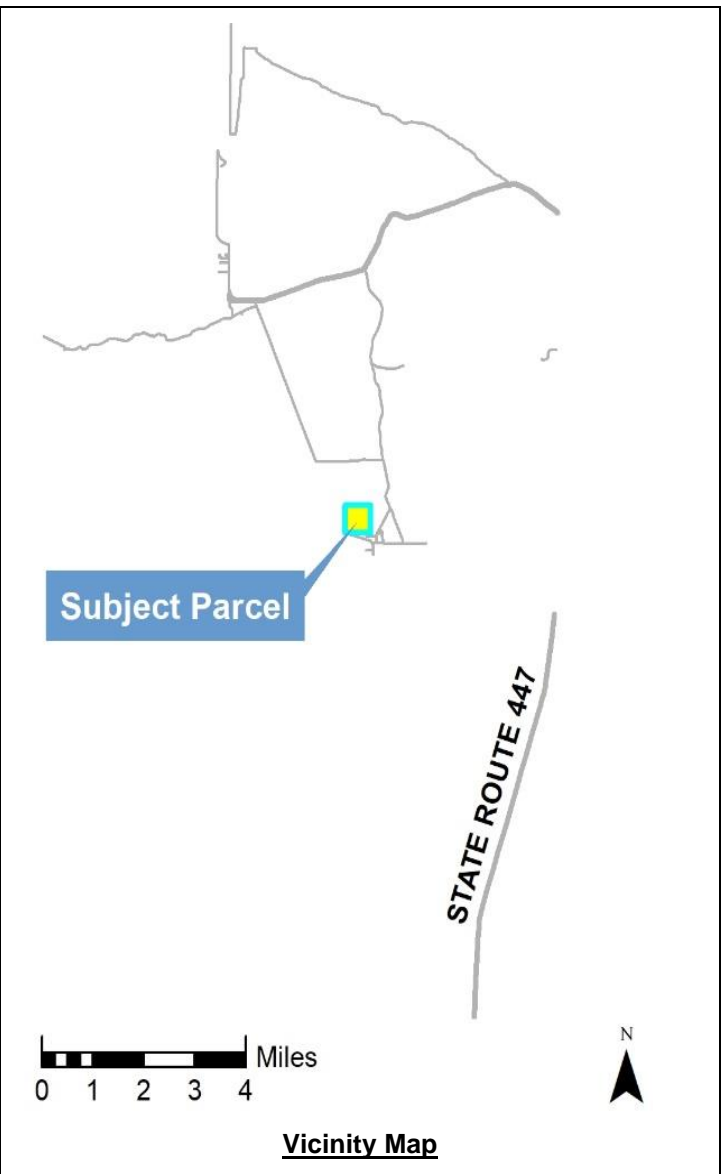

Vicinity Map

STAFF RECOMMENDATION

APPROVE

APPROVE WITH CONDITIONS

DENY

POSSIBLE MOTION

I move that, after giving reasoned consideration to the information contained in the staff report and information received during the public hearing, the Washoe County Planning Commission approve Special Use Permit Case Number WSUP22-0035 for Orni 36, LLC, with the conditions included as Exhibit A to this matter, having made all five findings in accordance with Washoe County Code Section 110.810.30 and the additional findings per 110.810.35 and to vary the development code standards found in Washoe County Code sections 110.410.25(e), 110.412.50, 110.406.05.1 as explained in pages 6-8 of this staff report :

(Motion with Findings on Page 12)

Staff Report Contents

Special Use Permit 4

Site Plan.....5

Project Evaluation..... 6

Area Plan Evaluation 9

Reviewing Agencies 10

Recommendation 122

Motion 122

Appeal Process 13

.....

Exhibits Contents

Conditions of Approval..... Exhibit A

Agency Comments Exhibit B

Public Notice Exhibit C

Project Application..... Exhibit D

Additional Application Materials Exhibit E

Special Use Permit

The purpose of a special use permit is to allow a method of review to identify any potential harmful impacts on adjacent properties or surrounding areas for uses that may be appropriate within a regulatory zone; and to provide for a procedure whereby such uses might be permitted by further restricting or conditioning them so as to mitigate or eliminate possible adverse impacts. If the Planning Commission grants an approval of the special use permit, that approval is subject to conditions of approval. Conditions of approval are requirements that need to be completed during different stages of the proposed project. Those stages are typically:

- Prior to permit issuance (i.e., a grading permit, a building permit, etc.)
- Prior to obtaining a final inspection and/or a certificate of occupancy on a structure
- Prior to the issuance of a business license or other permits/licenses
- Some conditions of approval are referred to as “operational conditions.” These conditions must be continually complied with for the life of the business or project.

The conditions of approval for Special Use Permit Case Number WSUP22-0035 are attached to this staff report and will be included with the action order.

The subject property has a regulatory zone designation of General Rural (GR). The proposed use of a photovoltaic facility, which is classified as energy production, renewable, is permitted in GR with a special use permit per WCC 110.302.05.4. Therefore, the applicant is seeking approval of this SUP from the Planning Commission. Grading associated with the photovoltaic facility will also result in a disturbed area greater than four acres which exceeds the thresholds for major grading per Article 438 of the Washoe County Development Code.

Additionally, Article 810, Special Use Permits, allows the Planning Commission to vary development code standards in conjunction with the approval process per WCC 110.810.20(e). The Planning Commission will be ruling on the request(s) to vary standards below:

Variance(s) Requested	Relevant Code
No paved parking	110.410.25(e)
No landscaping for parking areas	110.412.50
10-foot rear/front yard setback as opposed to 30-foot rear/front yard setback	Table 110.406.05.1

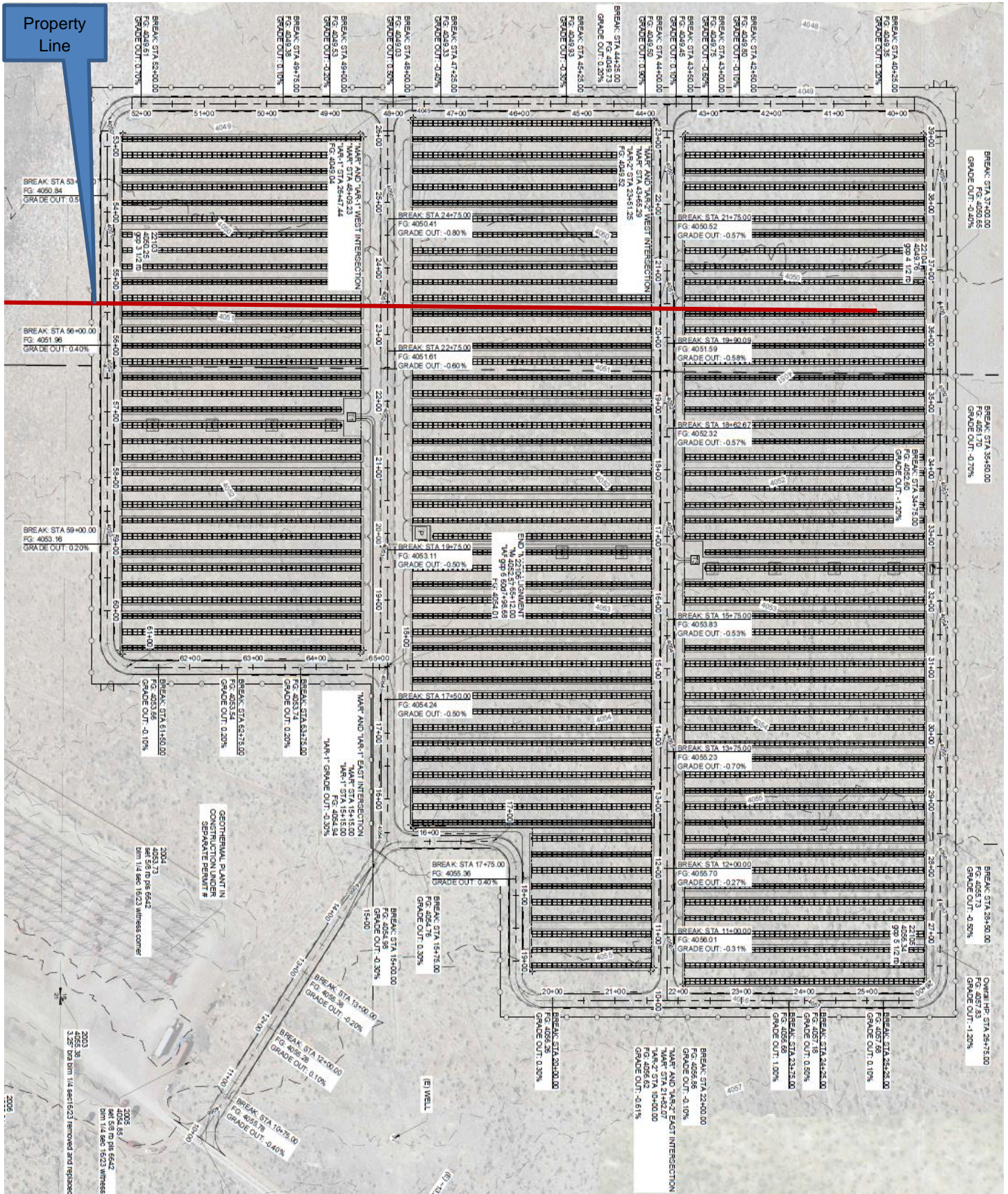

Site Plan

Project Evaluation

The applicant is requesting to establish a 5.5-MW solar photovoltaic generation facility across approximately 50.18 acres and two parcels 10 miles north of Pyramid Lake. The proposed facility is adjacent to the approved and under construction Ormat Geothermal Facility (WSUP20-0013) and will support the operations of the geothermal plant. The proposed project is intended to be constructed in a single phase in 2023. The applicant is requesting to waive all applicable landscaping standards and all standards associated with paved parking. This project meets the standard for a project of regional significance because it will generate more than 5 MW of electricity.

To enable the development of this solar facility, the applicant is also requesting a major grading permit for 4.65 acres of disturbance and 4,200cy of fill.

Setbacks in the General Rural (GR) regulatory zone are 30 feet from the front and rear property lines and 50 feet from the side property lines. As shown on the site plan above, a property line runs through the middle of the project with solar panels proposed within the setbacks. This shared property line is a rear and front line for each property respectively and thus subject to 30-foot setbacks on both sides. The applicant is requesting to vary this standard to allow for a 10-foot setback on each side.

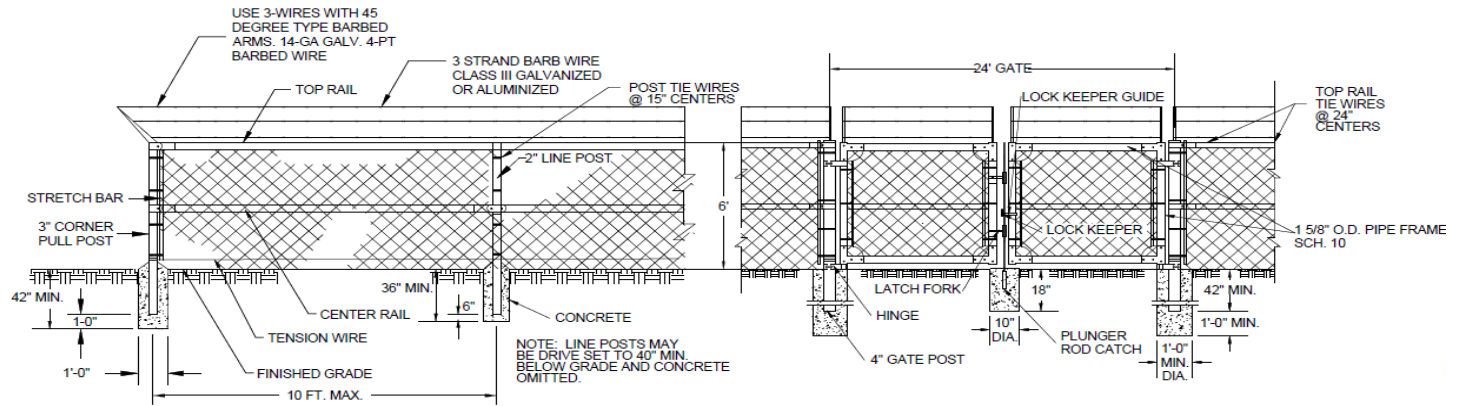

Fence Details

Site development includes 13,041 photovoltaic panels installed in strings, grading for ancillary areas and roads, and a 6-foot-tall chain link fence topped with barbed wire that surrounds the site. The fence shall be less than 8 feet in height in conformance with WCC 110.406.50(b).

Article 406 – Building Placement Standards

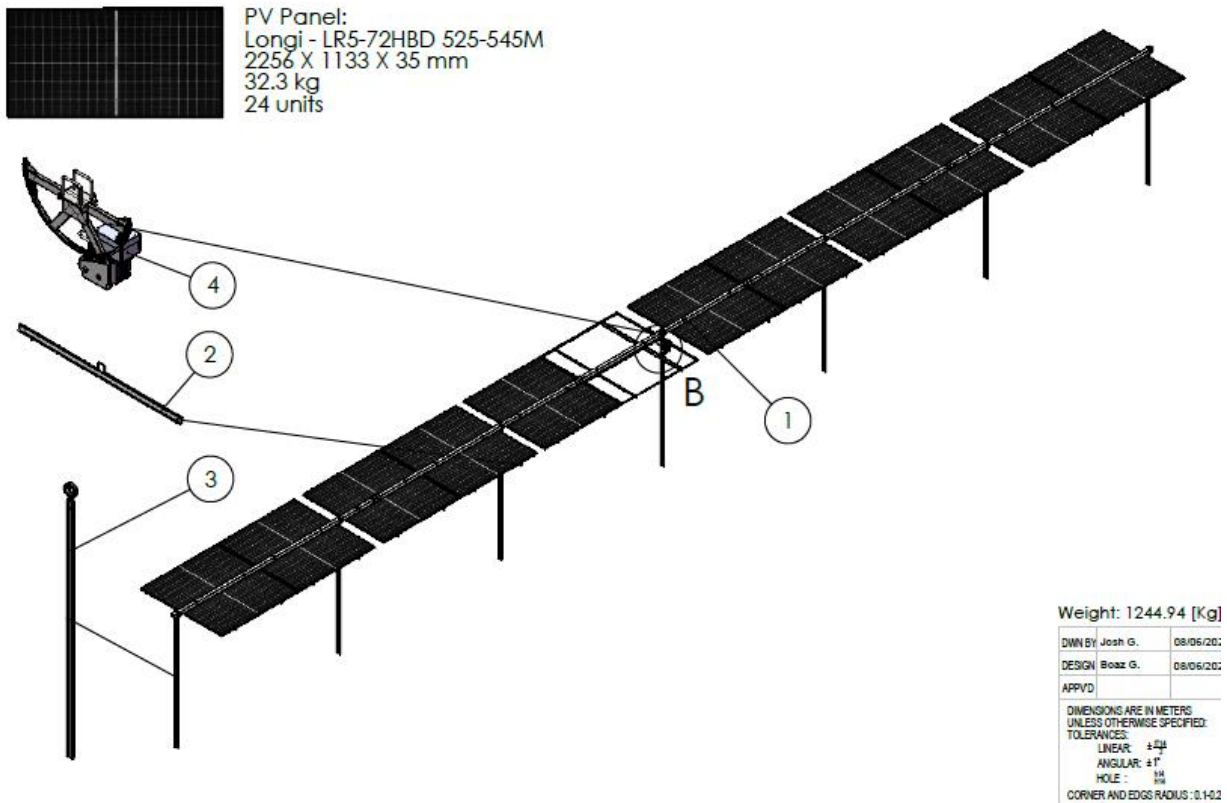

Panel Details

This photovoltaic project is proposed over two adjacent parcels, with solar panels proposed on both. The applicant has requested to vary the setback along the shared property line, reducing it from 30 to 10 feet on either side. Per the application, the reduction is necessary to accommodate the placement of the photovoltaic facility near the geothermal plant it is intended to support while maintaining proper panel orientation and minimizing earthwork. Minimizing earthwork and thus maintaining more natural vegetation on site is consistent with several goals of the High Desert Area Plan, including goals to preserve existing desert ecology and control noxious weeds. Solar developments have previously been approved over multiple parcels and staff does not believe that reducing the setback will cause any detriment. Both subject parcels share the same owner at this time and are leased by the applicant for the purpose of this solar project. Since a separation will still be maintained between the parcels and a smaller setback helps limit site disturbance, staff is supportive of varying the standard.

Article 410 – Parking and Loading

The proposed renewable energy production use type requires (1) parking space per employee during peak employment shift per WCC Table 110.410.10.4; (1) handicapped accessible space per Table 110.410.15.1; and (1) 25ft by 15ft loading space for every 20,000sf of gross floor area per 110.410.30(b).

The applicant anticipates that there will be a maximum of 1 employee on site at the facility during operations. This facility shall provide 1 total parking space in front of the power generation facilities, which must be a handicapped accessible space with applicable signage. However, if this facility qualifies for a Federal ADA machine space exemption, the handicapped parking requirement may be waived.

The applicant is also requesting to waive all parking requirements tied to paving in WCC 110.410.25 on the basis that paving is not appropriate for or consistent with this particular rural setting. This request encompasses WCC 110.410.25 (c-f). Staff agrees that the wheel stops, striping and marking, paving, and landscaping requirements do not fit the surrounding high desert environment. Therefore, staff has provided conditions in Exhibit A waiving the parking requirements found in 110.410.25(c-f).

The standards of WCC 110.410.25(a-b, h-i) will still be applicable to any proposed parking and cover parking stall sizing and access to the parking area. Full review of these standards will occur when the required parking space and any additional parking is shown at the building permit stage.

The applicant has not proposed a structure for employee operations and management. If they propose one in the future, the number of 25ft by 15ft loading spaces required for the building per 110.410.30(b) will be determined at the building permit stage of the process.

Article 412 – Landscaping

The project as proposed provides no formal landscaping. WCC 110.412.10(d) provides an exemption to the landscaping requirements for Energy Production, Renewable use types when located more than 1 mile from any residence, which exempts this project from all landscaping requirements outside of WCC 110.412.50, which addresses landscaping around parking and loading areas. The applicant is asking the Planning Commission to waive the provisions of WCC 110.412.50.

The applicant states that they are requesting to vary this standard because formal landscaping would negatively impact the character of the area, which is generally flat and characterized by low-lying native vegetation. Staff agrees and has proposed conditions of approval in Exhibit A waiving the formal landscaping standards outlined in WCC 110.412.50(a-g).

However, waiving the formal landscaping standards shall not exempt the applicant from the revegetation and stabilization requirements of WCC 110.438.70 and 110.438.77.

Article 414 – Lighting and Sound

No lighting is shown in the application. Any lighting fixtures proposed in the future will need to comply with the standards of Article 414.

Article 438 – Grading

The applicant is proposing approximately 4.65 acres (202,500 sf) of grading with little to no cut and 4,200 cubic yards of fill. This exceeds the major grading threshold; and thus, requires a special use permit per WCC 110.438.35. The proposed fill is Type II class B aggregate to construct IFC compliant access roads. Per High Desert policy 2.2, the applicant will be required to provide a noxious weed plan, which is enshrined in the conditions of Exhibit A. Furthermore, Washoe County Regional Parks and Open Space condition 7.a requires all imported material to be “certified weed free” (Exhibit A). The solar panels themselves are affixed to piles that are set in the ground and thus represent a small portion of the proposed grading.

All proposed slopes are 3:1 or less, in conformance with WCC 110.438.45(a). The largest difference between finished and natural grade is 1 foot—under the 10-foot limit—and fill slopes within the setbacks differ from natural grade less than 48 inches. No retaining walls or significant cuts are proposed. The grading complies with all applicable grading standards.

The applicant states that only incidental reseeding will be required, as disturbed areas shall be limited to small areas where the piles are set in the ground and access roadways which shall remain unvegetated. Per comments from the Truckee Meadows Fire District, the applicant will need to provide a vegetation management plan in accordance with Wildland Urban Interface Code (WUI) Appendix B.

Article 505 – Signs

No signs are proposed as part of this application. Any signs proposed in the future will need to comply with the standards of Article 505.

Article 810 – Special Use Permits

The proposed application qualifies as a development of Natural Resources SUP. Therefore, the following additional findings are required in accordance with WCC 110.810.35:

- a) The proposed development is not unduly detrimental to surrounding properties, land uses, and the environment in general;
- b) The proposed development will not unduly block scenic views or degrade surrounding scenic resources; and
- c) The proposed development will reclaim the site at the conclusion of the operation.

Article 812 – Projects of Regional Significance

This project meets the standard for a project of regional significance because it will generate more than 5 MW of electricity in compliance with the 2019 Truckee Meadows Regional Plan Appendix 2, subsection 2.

Area Plan Evaluation

The subject parcel is located within the High Desert Area Plan. The following are the pertinent policies from the Area Plan:

Relevant Area Plan Policies Reviewed

Policy	Brief Policy Description	Complies	Response
HD 2.2	Noxious weed plan required	Yes	Condition 1.k included in Exhibit A.
HD 2.8	All landscape designs will emphasize use of native and low water requirement vegetation	N/A	No landscaping is required per Conditions 1.f & 1.g in Exhibit A.
HD 2.10	Impacts of development will be mitigated	Yes	Staff has provided conditions of approval governing grading requirements, drainage maintenance and reclamation in Exhibit A
HD 2.13	Special Use Permit/ Admin. Permit finding that community character can be adequately conserved	Yes	Staff is able to make the finding that the proposed project will adequately preserve the community character as conditioned in Exhibit A.
HD 6.2	Fill slopes not to exceed 3:1 slope, hillside grading will establish a naturalistic appearance	Yes	Not applicable, this requirement is fulfilled under WCC 110.438.45
HD 6.4	Require eighty percent (80%) reestablishment of vegetation prior to release of the bonds.	Yes	Staff has provided conditions of approval requiring these standards in Exhibit A
HD 10.3	Special Use Permit finding of no significant degradation of air quality	Yes	Washoe County Air Quality Management Reviews the proposed application and provided conditions in Exhibit A.
HD 11.1	Development proposals to include a detailed soils and geotechnical study	Yes	Staff has provided conditions of approval requiring these standards in Exhibit A
HD 11.2	Development proposals will follow recommendations of geotechnical studies	Yes	Staff has provided conditions of approval requiring these standards in Exhibit A
HD 12.1	Master Plan Amendments, tentative maps, public initiated capital improvements, and projects impacting 10+ acres to consult with Nevada Department of Wildlife	Yes	Nevada Department of Wildlife indicated no concerns with the proposed development.
HD 12.2	Any development that has the potential to negatively impact an established wildlife migration route or critical habitat, federally classified Threatened and Endangered Species and their	Yes	Nevada Department of Wildlife indicated no concerns with the proposed development.

	associated habitat must demonstrate how that project will protect the integrity of the migration route or habitat.		
HD 15.3	Washoe County will work to ensure that the action of one property owner does not adversely impact the properties and rights of other property owners, as measured by increased flood peaks, volume of runoff, erosion, sedimentation, etc.	Yes	Staff has provided conditions of approval mitigating these impacts in Exhibit A.
HD 16.4	Water rights shall be dedicated to Washoe County.	Yes	Washoe County Water Rights reviewed the proposed application and provided conditions in Exhibit A.
HD 16.5	Landscaping using drought tolerant plant encouraged	N/A	No landscaping is required per Conditions 1.f & 1.g in Exhibit A.
HD 18.2	Use of curb and gutter will be minimized	Yes	The proposed application does not include any curb and gutter.

Reviewing Agencies

The following agencies/individuals received a copy of the project application for review and evaluation.

Agencies	Sent to Review	Responded	Provided Conditions	Contact
BLM - Winnemucca Dist. Office	X			
NDOW (Wildlife)	X			
NV Water Resources	X	X	X	Steve Shell, sshell@water.nv.gov
Washoe County Building & Safety	X			
Washoe County Engineering & Capital Projects	X	X	X	Robert Wimer, rwimer@washoecounty.gov
Washoe County Land Development (All Apps)	X			
Washoe County Parks & Open Space	X	X	X	Faye-Marie Pekar, fpekar@washoecounty.gov
Washoe County Sewer	X			
Washoe County Traffic	X			
Washoe County Water Rights Manager (All Apps)	X	X	X	Timber Weiss, tweiss@washoecounty.gov
WCHD Air Quality	X	X	X	Genine Rosa, grosa@washoecounty.gov
WCHD EMS	X	X		Sabrina Brasuell, sbrasuell@washoecounty.gov
WCHD Environmental Health	X	X	X	James English, jenglish@washoecounty.gov
TMFPD	X	X	X	Brittany Lemon, blemon@tmfpd.us
Regional Transportation Commission2	X			
Truckee Meadows Regional Planning	X	X		Nate Kusha, nkusha@tmrpa.org
Washoe-Storey Conservation District2	X			
Nevada State Historic Preservation	X			
Pyramid Lake Paiute Tribe	X			
NV Energy	X			

All conditions required by the contacted agencies can be found in Exhibit A, Conditions of Approval.

Staff Comment on Required Findings

WCC Section 110.810.30, Article 810, *Special Use Permits*, requires that all of the following findings be made to the satisfaction of the Washoe County Planning Commission before granting approval of the request. Staff has completed an analysis of the special use permit application and has determined that the proposal is in compliance with the required findings as follows.

- (a) **Consistency.** That the proposed use is consistent with the action programs, policies, standards and maps of the Master Plan and the High Desert Area Plan.

Staff Comment: The proposed use is consistent with the action programs, policies standards and maps of the Master Plan and the High Desert Area Plan as outlined above and conditioned in Exhibit A.

- (b) **Improvements.** That adequate utilities, roadway improvements, sanitation, water supply, drainage, and other necessary facilities have been provided, the proposed improvements are properly related to existing and proposed roadways, and an adequate public facilities determination has been made in accordance with Division Seven.

Staff Comment: The proposed photovoltaic facility has been reviewed by Washoe County Engineering, who provided conditions of approval mitigating the impacts of grading and drainage. The Nevada Division of Water Resources provided conditions regarding water rights and use. No reviewing agency indicated concerns with infrastructure or improvements.

- (c) **Site Suitability.** That the site is physically suitable for an energy production, renewable use and major grading, and for the intensity of such a development.

Staff Comment: The proposed site is relatively flat and suitable for an energy production use type. The area is labeled as unconstrained per the High Desert Area Plan Development Suitability Map. Washoe County Engineering reviewed this application and indicated no concerns about site suitability.

- (d) **Issuance Not Detrimental.** That issuance of the permit will not be significantly detrimental to the public health, safety or welfare; injurious to the property or improvements of adjacent properties; or detrimental to the character of the surrounding area.

Staff Comment: Staff has provided conditions of approval to mitigate impacts of the proposed use on public health, safety, and welfare. The conditions in Exhibit A also allow variations from Washoe County development standards that help preserve the character of the surrounding area. Furthermore, the site's location adjacent to a geothermal plant will help minimize the addition of off-site infrastructure to support that plant.

- (e) **Effect on a Military Installation.** Issuance of the permit will not have a detrimental effect on the location, purpose or mission of the military installation.

Staff Comment: There are no military installations within the noticing area of the proposed facility.

Additional findings per 110.810.35:

- (a) **Environment.** That the proposed development is not unduly detrimental to surrounding properties, land uses and the environment in general;

Staff Comment: The proposed application was forwarded to the Nevada Division of Wildlife (NDOW) for comment. They did not indicate any concerns. Washoe County staff reviewed the impacts of this development relative to mapped wildlife corridors, drainage, and development suitability maps in the Conservation Element and High Desert Area Plan and found that the project site is suitable for development and contains no high-sensitivity wildlife ranges or corridors.

- (b) **Impact on Scenic Resources.** That the proposed development will not unduly block scenic views or degrade any surrounding scenic resources; and

Staff Comment: The proposed facility will abide by the 35ft height maximum for General Rural regulatory zoned parcels, the panels themselves proposed to rise a maximum of 8.5 feet above grade. This will not unduly block scenic views or degrade surrounding scenic resources.

- (c) Reclamation. That the proposed development will reclaim the site and all affected areas at the conclusion of the operation.

Staff Comment: Staff has provided conditions of approval in Exhibit A requiring a reclamation plan and reclamation bond for the proposed facility.

Recommendation

After a thorough analysis and review, Special Use Permit Case Number WSUP22-0035 is being recommended for approval with conditions. Staff offers the following motion for the Commission's consideration.

Motion

I move that, after giving reasoned consideration to the information contained in the staff report and information received during the public hearing, the Washoe County Planning Commission approve Special Use Permit Case Number WSUP22-0035 for Orni 36, LLC, with the conditions included as Exhibit A to this matter, having made all five findings in accordance with Washoe County Code Section 110.810.30 and having made the additional findings per 110.810.35, which are listed below. I further move to vary the development code standards found in Washoe County Code sections 110.410.25(e), 110.412.50, 110.406.05.1 as explained in pages 6-8 of this staff report.

Washoe County Code 110.810.30:

- (a) Consistency. That the proposed use is consistent with the action programs, policies, standards and maps of the Master Plan and the High Desert Area Plan;
- (b) Improvements. That adequate utilities, roadway improvements, sanitation, water supply, drainage, and other necessary facilities have been provided, the proposed improvements are properly related to existing and proposed roadways, and an adequate public facilities determination has been made in accordance with Division Seven;
- (c) Site Suitability. That the site is physically suitable for an energy production, renewable use and major grading, and for the intensity of such a development;
- (d) Issuance Not Detrimental. That issuance of the permit will not be significantly detrimental to the public health, safety or welfare; injurious to the property or improvements of adjacent properties; or detrimental to the character of the surrounding area;
- (e) Effect on a Military Installation. Issuance of the permit will not have a detrimental effect on the location, purpose or mission of the military installation.

WCC 110.810.35:

- (a) Environment. That the proposed development is not unduly detrimental to surrounding properties, land uses and the environment in general;
- (b) Impact on Scenic Resources. That the proposed development will not unduly block scenic views or degrade any surrounding scenic resources; and
- (c) Reclamation. That the proposed development will reclaim the site and all affected areas at the conclusion of the operation.

Appeal Process

Planning Commission action will be effective 10 calendar days after the written decision is filed with the Secretary to the Planning Commission and mailed to the applicant, unless the action is appealed to the Washoe County Board of County Commissioners, in which case the outcome of the appeal shall be determined by the Washoe County Board of County Commissioners. Any appeal must be filed in writing with the Planning and Building Division within 10 calendar days from the date the written decision is filed with the Secretary to the Planning Commission and mailed to the applicant.

Applicant: Orni 36, LLC, efreese@ormat.com

Property Owner: Kosmos Company, chris.kosmos@kosmosllc.com

Representatives: Wood Rodgers, Inc, shuggins@woodrodgers.com



Conditions of Approval

Special Use Permit Case Number WSUP22-0035

The project approved under Special Use Permit Case Number WSUP22-0035 shall be carried out in accordance with the conditions of approval granted by the Planning Board on January 3, 2023. Conditions of approval are requirements placed on a permit or development by each reviewing agency. These conditions of approval may require submittal of documents, applications, fees, inspections, amendments to plans, and more. These conditions do not relieve the applicant of the obligation to obtain any other approvals and licenses from relevant authorities required under any other act.

Unless otherwise specified, all conditions related to the approval of this special use permit shall be met or financial assurance must be provided to satisfy the conditions of approval prior to issuance of a grading or building permit. The agency responsible for determining compliance with a specific condition shall determine whether the condition must be fully completed or whether the applicant shall be offered the option of providing financial assurance. All agreements, easements, or other documentation required by these conditions shall have a copy filed with the County Engineer and the Planning and Building Division.

Compliance with the conditions of approval related to this special use permit is the responsibility of the applicant, his/her successor in interest, and all owners, assignees, and occupants of the property and their successors in interest. Failure to comply with any of the conditions imposed in the approval of the special use permit may result in the institution of revocation procedures.

Washoe County reserves the right to review and revise the conditions of approval related to this Special Use Permit should it be determined that a subsequent license or permit issued by Washoe County violates the intent of this approval.

For the purpose of conditions imposed by Washoe County, “may” is permissive and “shall” or “must” is mandatory.

Conditions of approval are usually complied with at different stages of the proposed project. Those stages are typically:

- Prior to permit issuance (i.e., grading permits, building permits, etc.).
- Prior to obtaining a final inspection and/or a certificate of occupancy.
- Prior to the issuance of a business license or other permits/licenses.
- Some “conditions of approval” are referred to as “operational conditions.” These conditions must be continually complied with for the life of the project or business.

The Washoe County Commission oversees many of the reviewing agencies/departments with the exception of the following agencies.

- **The DISTRICT BOARD OF HEALTH, through the Washoe County Health District, has jurisdiction over all public health matters in the Health District. Any conditions set by the Health District must be appealed to the District Board of Health.**

FOLLOWING ARE CONDITIONS OF APPROVAL REQUIRED BY THE REVIEWING AGENCIES. EACH CONDITION MUST BE MET TO THE SATISFACTION OF THE ISSUING AGENCY.

Washoe County Planning and Building Division

1. The following conditions are requirements of Planning and Building, which shall be responsible for determining compliance with these conditions.

Contact Name – Kat Oakley, Planner, 775.328.3628, koakley@washoecounty.gov

- a. **The applicant shall attach a copy of the action order approving this project to all permits and applications (including building permits) applied for as part of this special use permit.**
- b. The applicant shall demonstrate substantial conformance to the plans approved as part of this special use permit.
- c. The applicant shall submit construction plans, with all information necessary for comprehensive review by Washoe County, and initial building permits shall be issued within two years from the date of approval by Washoe County. The applicant shall complete construction within the time specified by the building permits.
- d. A note shall be placed on all construction drawings and grading plans stating:

NOTE

Should any cairn or grave of a Native American be discovered during site development, work shall temporarily be halted at the specific site and the Sheriff's Office as well as the State Historic Preservation Office of the Department of Conservation and Natural Resources shall be immediately notified per NRS 383.170.

- e. The business license will be obtained to for the new use.
- f. The facility shall be exempted from the parking standard requirements found in WCC 110.410.25(c-f) except for the required ADA parking spot, unless exempted under the federal machine space exemption, in order to maintain the High Desert character under High Desert Policy 2.13
- g. The facility shall be exempted from the formal landscaping standards found in WCC 110.412.50(a-g) in order to maintain the High Desert character under High Desert Policy 2.13.
- h. The applicant shall provide detailed soils and geo-technical studies as part of the required grading permit plans per High Desert Policy 11.1. These plans shall comply with WCC 110.438.45-100.
- i. In conformance with Washoe County Code Section 110.810.35(c), a reclamation plan shall be prepared prior to the issuance of building or grading permits. This shall ensure that the solar panels and associated infrastructure are properly decommissioned, and the site is restored at the end of the solar facility's useful life. The plan shall be developed in consultation with the Nevada Department of Wildlife and/or the Nevada Department of Environmental Protection. At a minimum, the plan will include:
 - i. existing site conditions;
 - ii. the area of impact (to include all portions of the subject site);
 - iii. reclamation goals and methods;
 - iv. measures to prevent the spread of noxious weeds;
 - v. analysis of reclamation costs;
 - vi. reclamation success criteria; and appropriate monitoring provisions.

- j. Prior to the issuance of building/grading permits, the applicant shall post a financial assurance for reclamation for eighty percent (80%) of the total reclamation costs as identified in the reclamation plan per condition 1i.
- i. At a minimum, revegetation of the site must result in eighty percent (80%) re-establishment of vegetation prior to the release of the bonds in accordance with High Desert Policy 6.4.
- k. In conformance with the High Desert Area Plan Policy 2.2, prior to the issuance of building or grading permits, the applicant shall prepare a noxious weed management plan in consultation with the Washoe County Health Department, the University of Nevada Cooperative Extension, and/or the Washoe Storey Conservation District.
- l. Construction hours are 7am to 7pm Monday through Saturday.
- m. The following **Operational Conditions** shall be required for the life of the business:
 - i. This special use permit shall remain in effect until or unless it is revoked or is inactive for one year.
 - ii. Failure to comply with any of the conditions of approval shall render this approval out of conformance and subject to revocation.
 - iii. The applicant and any successors shall direct any potential purchaser/operator of the site and/or the special use permit to meet with Planning and Building to review conditions of approval prior to the final sale of the site and/or the special use permit. Any subsequent purchaser/operator of the site and/or the special use permit shall notify Planning and Building of the name, address, telephone number, and contact person of the new purchaser/operator within 30 days of the final sale.
 - iv. This special use permit shall remain in effect as long as the business is in operation and maintains a valid business license.

Washoe County Engineering and Capital Projects

- 2. The following conditions are requirements of the Engineering Division, which shall be responsible for determining compliance with these conditions.

Contact Name – Robert Wimer, PE, 775.328.2059, rwimer@washoecounty.gov

- a. A complete set of construction improvement drawings, including an on-site grading plan, shall be submitted when applying for a building/grading permit. Grading shall comply with best management practices (BMP's) and shall include detailed plans for grading, site drainage, erosion control (including BMP locations and installation details), slope stabilization, and mosquito abatement. Placement or removal of any excavated materials shall be indicated on the grading plan. Silts shall be controlled on-site and not allowed onto adjacent property.
- b. For construction areas larger than 1 acre, the developer shall obtain from the Nevada Division of Environmental Protection a Stormwater Discharge Permit or Waiver for construction and submit a copy to the Engineering Division prior to issuance of a grading permit.
- c. The developer shall complete and submit the Construction Permit Submittal Checklist and pay the Construction Stormwater Inspection Fee prior to obtaining a grading permit. The County Engineer shall determine compliance with this condition.
- d. A grading bond of \$2,000/acre of disturbed area shall be provided to the Engineering Division prior to any grading.

- e. Cross-sections indicating cuts and fills shall be submitted when applying for a grading permit. Estimated total volumes shall be indicated.
- f. All disturbed areas left undeveloped for more than 30 days shall be treated with a dust palliative. Disturbed areas left undeveloped for more than 45 days shall be revegetated. Methods and seed mix must be approved by the County Engineer with technical assistance from the Washoe-Storey Conservation District. The applicant shall submit a revegetation plan to the Washoe-Storey Conservation District for review.
- g. The following note shall be added to the construction drawings; "All properties, regardless if they are located within or outside of a FEMA designated flood zone, may be subject to flooding. The property owner is required to maintain all drainage easements and natural drainages and not perform or allow unpermitted and unapproved modifications to the property that may have detrimental impacts to surrounding properties."

Washoe County Health District

- 3. The following condition is a requirement of the Health District, which shall be responsible for determining compliance with this condition. The District Board of Health has jurisdiction over all public health matters in the Health District. Any conditions set by the Health District must be appealed to the District Board of Health.

**Contact Name – James English, EHS Supervisor, 775.328.2434,
jenglish@washoecounty.gov**

- a. The Washoe County Health District (WCHD) will review the project in full through the construction plan review process.
 - b. If the special use permit is approved, all future plans and permits must be routed through the WCHD for review and approval.
- 4. The following condition is a requirement of the Health District, which shall be responsible for determining compliance with this condition. The District Board of Health has jurisdiction over all public health matters in the Health District. Any conditions set by the Health District must be appealed to the District Board of Health.

**Contact Name – Genine Rosa, Senior Air Quality Specialist, 775.784.7204,
grosa@washoecounty.gov**

- a. Any dust generating activity, regardless of size of disturbance, will be subject to the Washoe County District Board of Health Regulation Governing the Air Quality Management Division, 040.030 Dust Control. Except when engaged in commercial agricultural operations, no person may disturb the topsoil by removing, altering, or overlaying the ground cover through scraping, burning, excavating, storing of fill, application of palliative, or any other method on any real property unless reasonable precautions are taken to prevent generation of dust during both the active development phases and thereafter if the property is to remain unoccupied, unused, vacant, or undeveloped. If disturbance will be greater than 1 acre, then a Dust Control Permit will be required prior to breaking ground.

Truckee Meadows Fire Protection District

- 5. The following condition is a requirement of the Truckee Meadows Fire Protection District, which shall be responsible for determining compliance with this condition.

Contact Name – Brittany Lemon, Fire Captain, 775.326.6079, blemon@tmfpd.us

- a. This project shall meet and comply with all requirements of currently adopted TMFPD fire codes, ordinances, and standards at the time of construction to include infrastructure for fire apparatus access roads and water supply. <https://tmfpd.us/fire-code/>
- b. A vegetation management plan in accordance with the adopted Wildland Urban Interface code (WUI) Appendix B is required for this project.

Nevada Division of Water Resources

6. The following conditions are requirements of the Nevada Division of Water Resources, who shall be responsible for determining compliance with these conditions.

Contact: Contact: Steve Shell, Water Resource Specialist, 775.684.3826, sshell@water.nv.gov

- a. The project proposes to use private wells as a source of water. A water permit issued by the Division of Water Resources is required.

Washoe County Regional Parks and Open Space

7. The following conditions are requirements of Regional Parks and Open Space, which shall be responsible for determining compliance with these conditions.

Contact Name – Faye-Marie Pekar, Parks Planner, 775.328.6100, fpekar@washoecounty.gov

- a. All earthen material imported as part of this project is required to be “certified weed free” in order to prevent the spread of noxious weeds within the county.
- b. Prior to the issuance of building/grading permits, the applicant shall update the existing revegetation plan for the overall project (WSUP20-013 Ormat Geothermal) to include the new proposed disturbance area from the current proposal (WSUP22-0035).
Revegetation is required for all temporary disturbance areas. Revegetation plan shall be prepared by a biologist or other qualified professional, to Washoe County Parks for review and approval. At a minimum, the plan will include: existing site conditions; the area of impact; restoration goals; selection of native/perennial adapted plants or seed mixes; revegetation methods; measures to prevent the spread of noxious weeds; revegetation success criteria; and appropriate monitoring provisions.

*** End of Conditions ***



Date: November 28, 2022

To: Kat Oakley, Planner

From: Robert Wimer, P.E., Licensed Engineer

Re: Special Use Permit for **North Valleys Geothermal Solar Project WSUP22-0035**
APN 071-070-12, 071-070-13

GENERAL PROJECT DISCUSSION

Washoe County Engineering staff has reviewed the above referenced application. The Special Use Permit is for the construction of a 5.5 MW photovoltaic solar field and is located on approximately 263 acres approximately 10 miles north of Pyramid Lake. The Engineering and Capital Projects Division recommends approval with the following comments and conditions of approval which supplement applicable County Code and are based upon our review of the site and the application prepared by Wood Rodgers, Inc. The County Engineer shall determine compliance with the following conditions of approval.

For questions related to sections below, please see the contact name provided.

GENERAL CONDITIONS

Contact Information: Robert Wimer, P.E. (775) 328-2059

1. A complete set of construction improvement drawings, including an on-site grading plan, shall be submitted when applying for a building/grading permit. Grading shall comply with best management practices (BMP's) and shall include detailed plans for grading, site drainage, erosion control (including BMP locations and installation details), slope stabilization, and mosquito abatement. Placement or removal of any excavated materials shall be indicated on the grading plan. Silts shall be controlled on-site and not allowed onto adjacent property.
2. For construction areas larger than 1 acre, the developer shall obtain from the Nevada Division of Environmental Protection a Stormwater Discharge Permit or Waiver for construction and submit a copy to the Engineering Division prior to issuance of a grading permit.
3. The developer shall complete and submit the Construction Permit Submittal Checklist and pay the Construction Stormwater Inspection Fee prior to obtaining a grading permit. The County Engineer shall determine compliance with this condition.

WSUP22-0035
NORTH VALLEY SOLAR
EXHIBIT B

4. A grading bond of \$2,000/acre of disturbed area shall be provided to the Engineering Division prior to any grading.
5. Cross-sections indicating cuts and fills shall be submitted when applying for a grading permit. Estimated total volumes shall be indicated.
6. All disturbed areas left undeveloped for more than 30 days shall be treated with a dust palliative. Disturbed areas left undeveloped for more than 45 days shall be revegetated. Methods and seed mix must be approved by the County Engineer with technical assistance from the Washoe-Storey Conservation District. The applicant shall submit a revegetation plan to the Washoe-Storey Conservation District for review.

DRAINAGE (COUNTY CODE 110.416, 110.420, and 110.421)

Contact Information: Robert Wimer, P.E. (775) 328-2059

1. The following note shall be added to the construction drawings; "All properties, regardless if they are located within or outside of a FEMA designated flood zone, may be subject to flooding. The property owner is required to maintain all drainage easements and natural drainages and not perform or allow unpermitted and unapproved modifications to the property that may have detrimental impacts to surrounding properties."

TRAFFIC AND ROADWAY (COUNTY CODE 110.436)

Contact Information: Mitch Fink, (775) 328-2050

1. No traffic related conditions.

Oakley, Katherine

From: Lemon, Brittany
Sent: Monday, November 28, 2022 11:09 AM
To: Oakley, Katherine
Cc: Way, Dale
Subject: WSUP22-0035 (North Valleys Geothermal Solar Project) Conditions of Approval

Hi Kat,

“This project shall meet and comply with all requirements of currently adopted TMFPD fire codes, ordinances, and standards at the time of construction to include infrastructure for fire apparatus access roads and water supply.”
<https://tmfpd.us/fire-code/>.

A vegetation management plan in accordance with the adopted Wildland Urban Interface Code (WUI) Appendix B is required for this project.

Thank you,

Brittany Lemon

Fire Captain - Fire Prevention | Truckee Meadows Fire & Rescue

blemon@tmfpd.us | Office: 775.326.6079 | Cell: 775.379.0584

3663 Barron Way, Reno, NV 89511



"Committed to excellence, service, and the protection of life and property in our community"

Oakley, Katherine

From: Steve Shell <sshell@water.nv.gov>
Sent: Thursday, November 17, 2022 2:04 PM
To: Oakley, Katherine
Subject: FW: November Agency Review Memo I
Attachments: November Agency Review Memo I.pdf

[NOTICE: This message originated outside of Washoe County -- **DO NOT CLICK** on links or open **attachments** unless you are sure the content is safe.]

Regarding #2:
The project proposes to use private wells as a source of water.
A water permit issued by the Division of Water Resources is required.

As of June 1, 2021, the Office of the State Engineer is open to the public. Please call 684-2800 upon arrival and a representative will come down to escort you to our office.

Steve Shell
Nevada Division of Water Resources
775-684-2836

From: Roman, Brandon <BRoman@washoecounty.gov>
Sent: Tuesday, November 15, 2022 3:35 PM
To: Steve Shell <sshell@water.nv.gov>
Subject: November Agency Review Memo I

WARNING - This email originated from outside the State of Nevada. Exercise caution when opening attachments or clicking links, especially from unknown senders.

Good afternoon,

Please find the attached **Agency Review Memo I** with cases received in **November** by Washoe County Community Services Department, Planning and Building Division.

You've been asked to review the applications for the items indicated below. The item descriptions and links to the applications are provided in the memo. **Comments are due by November 28, 2022.**

Please remember to send any agency review responses/comments directly to the Planner for the case, rather than replying to me.

~~~~~

Ladera Ranch - **Item 1**

Regards,



**WASHOE COUNTY**  
**COMMUNITY SERVICES**  
**INTEGRITY COMMUNICATION SERVICE**

1001 E. 9<sup>th</sup> St.  
Reno, NV 89512  
Reno, Nevada 89520-0027  
Phone: (775) 328-3600  
Fax: (775) 328-3699

November 16, 2022

TO: Kat Oakley, Planner, CSD, Planning & Development Division

FROM: Timber Weiss, Licensed Engineer, CSD

SUBJECT: Special Use Permit Case Number WSUP22-0035 (North Valleys Geothermal Solar Project)

**Project description:**

The applicant is proposing to approve a special use permit for a) energy production, renewable use type for a photovoltaic facility with a capacity of 5.5 MW, which surpasses the 5 MW threshold for a project of regional significance and thus will require conformance review by the Truckee Meadows Regional Planning Commission, and b) associated grading resulting in a disturbed area of 4.65 acres and using 4,200 cubic yards of fill.

Location: Approximately 10 miles north of Pyramid Lake, APN: 071-070-12.

*The Community Services Department (CSD) recommends approval of this project with the following Water Rights conditions:*

Recommend approval, this application mentions water use for dust control and refers to WSUP20-0013, which accounts the water rights on this property. The water rights on this property are certificated for industrial use, which qualifies the proposed water use under this SUP.

Recommend approval of the Special Use Permit based on the water rights appurtenant to this and surrounding properties.



## INITIAL REVIEW MEMORANDUM

TO: Kat Oakley, City of Reno

FROM: Nate Kusha, TMRPA

DATE: November 29, 2022

**SUBJECT: TMRPA initial review of the Washoe County case WSUP22-0035 (North Valleys Geothermal Project)**

---

This memorandum provides the Truckee Meadows Regional Planning Agency’s (TMRPA) initial review comments regarding the subject case (WSUP22-0035), as stated in the 2019 Truckee Meadows Regional Plan (Policy RC 5).

The following constitutes an initial review based on the limited information available at the time of this memorandum. TMRPA recognizes that the proposal may change through the jurisdictional review of the case. Should the case be approved through Washoe County, the proposal will need to be formally submitted to TMRPA for a review of conformance with the 2019 Truckee Meadows Regional Plan in its entirety.

The request, as described in the materials provided by Washoe County, is the following:

Special Use Permit Case Number WSUP22-0035:

For hearing, discussion, and possible action to approve a special use permit for **a) energy production, renewable use type for a photovoltaic facility with a capacity of 5.5 MW, which surpasses the 5 MW threshold for a project of regional significance and thus will require conformance review by the Truckee Meadows Regional Planning Commission**, and b) associated grading resulting in a disturbed area of 4.65 acres and using 4,200 cubic yards of fill.

[TMRPA notes: **bolded text** identifies the portion of the request that is subject to review under the Regional Plan]

### Potential conformance issues

TMRPA has not identified any potential conformance issues at this time.

### Regional Plan policies for consideration in the analysis

RF 11 – Compatibility Factors

PF 18 – Regional Renewable Energy Generation

NR 2 – Resilient Region



NR 14 – Sustainable Development

RC 9 – Conformance Review Findings

**Data and information related to Regional Plan implementation**

Regional Land Designation: Rural Area

**Request for comment from other local government and/or affected entities**

Please coordinate and request comment from the Pyramid Lake Paiute Tribe as well as the Bureau of Land Management, due to the location of the project.

**Other information for review**

None at this time

**TMRPA Staff Notes**

None at this time

Please do not hesitate to contact TMRPA staff at 775-321-8385 if you have any questions or comments on this initial review memorandum. For more information, you can access the [2019 Truckee Meadows Regional Plan](#) and the [Regional Data Viewer](#) at [www.tmrpa.org](http://www.tmrpa.org).

## Oakley, Katherine

---

**From:** Rosa, Genine  
**Sent:** Tuesday, November 29, 2022 2:39 PM  
**To:** Oakley, Katherine  
**Subject:** Special Use Permit Case Number WSUP22-0035 (North Valleys Geothermal Solar Project)

Sorry...I'm a day late on this...

Any dust generating activity, regardless of size of disturbance, will be subject to the Washoe County District Board of Health Regulation Governing the Air Quality Management Division, 040.030 Dust Control. Except when engaged in commercial agricultural operations, no person may disturb the topsoil by removing, altering, or overlaying the ground cover through scraping, burning, excavating, storing of fill, application of palliative, or any other method on any real property unless reasonable precautions are taken to prevent generation of dust during both the active development phases and thereafter if the property is to remain unoccupied, unused, vacant or undeveloped.

If disturbance will be greater than 1 acre then a Dust Control Permit will be required prior to breaking ground, failure to do so may result in enforcement action resulting in a Notice of Violation with associated fines. For Dust Control Permit questions call AQMD at 775-784-7200 or visit [www.OurCleanAir.com](http://www.OurCleanAir.com).

P.S. – Please be sure to click the link below and sign up to receive air quality news, updates, public notices and more via e-mail.

### Genine Rosa

Senior Air Quality Specialist | Air Quality Management Division | Washoe County Health District  
[grosa@washoecounty.gov](mailto:grosa@washoecounty.gov) | O: (775) 784-7204 | 1001 E. Ninth St., Bldg. B, Reno, NV 89512

\*My work hours are M – Th 7am – 4:30 pm and Friday 7-11 am

[www.OurCleanAir.com](http://www.OurCleanAir.com) | [Subscribe to get Air Quality Updates!](#)



Please take our customer satisfaction survey by clicking [here](#)

November 29, 2022

Washoe County Community Services  
Planning and Development Division

RE: North Valleys Geothermal Solar Project; 071-070-12  
Special Use Permit; WSUP22-0035

Dear Washoe County Staff:

The following conditions are requirements of the Washoe County Health District, Environmental Health Division, which shall be responsible for determining compliance with these conditions.

**Contact Name – James English - [jenglish@washoecounty.us](mailto:jenglish@washoecounty.us)**

- a) Condition #1: The WCHD has reviewed the application as submitted and does not have any concerns, comments or conditions for the proposed project.
- b) Condition #2: The WCHD will review the project in full through the construction plan review process.
- c) Condition #3: If the special use permit is approved, all future plans and permits must be routed through the WCHD for review and approval.

If you have any questions or would like clarification regarding the foregoing, please contact James English, EHS Supervisor at [jenglish@washoecounty.us](mailto:jenglish@washoecounty.us) regarding all Health District comments.

Sincerely,



James English, REHS, CP-FS  
EHS Supervisor  
Environmental Health Services  
Washoe County Health District



## Oakley, Katherine

---

**From:** Program, EMS  
**Sent:** Wednesday, November 16, 2022 8:06 AM  
**To:** Oakley, Katherine  
**Cc:** Program, EMS  
**Subject:** FW: November Agency Review Memo I  
**Attachments:** November Agency Review Memo I.pdf

Good morning,

The EMS Program has reviewed the November Agency Review Memo I - Special Use Permit Case Number WSUP22-0035 (North Valleys Geothermal Solar Project) - and has no concerns or questions at this time based on the information provided.

Thank you,

Sabrina.

### Sabrina Brasuell

Pronouns: she/her

EMS Coordinator | Epidemiology and Public Health Preparedness

Washoe County Health District

[sbrasuell@washoecounty.gov](mailto:sbrasuell@washoecounty.gov) | Cell: (775) 830-7118 | Office: (775) 326-6043

1001 E. Ninth St., Bldg. B. Reno, NV 89512

**WASHOE COUNTY  
HEALTH DISTRICT**



ENHANCING QUALITY OF LIFE

Public Health

Please take our customer satisfaction survey by clicking [here](#)

---

**From:** Roman, Brandon <BRoman@washoecounty.gov>

**Sent:** Tuesday, November 15, 2022 3:37 PM

**To:** Holly, Dan <DHolly@washoecounty.gov>; Heeran, Jennifer <JHeeran@washoecounty.gov>; Giesinger, Chad <CGiesinger@washoecounty.gov>; Wimer, Robert <RWimer@washoecounty.gov>; Lowden, Joanne <JLowden@washoecounty.gov>; Handrock, Wayne <WHandrock@washoecounty.gov>; Philumalee, Matthew <MPhilumalee@washoecounty.gov>; Fink, Mitchell <MFink@washoecounty.gov>; Weiss, Timber A. <TWeiss@washoecounty.gov>; Rosa, Genine <GRosa@washoecounty.gov>; Restori, Joshua <JRestori@washoecounty.gov>; Program, EMS <EMSProgram@washoecounty.gov>; English, James <JEnglish@washoecounty.gov>; Rubio, Wesley S <WRubio@washoecounty.gov>; Kelly, David A <DAKelly@washoecounty.gov>

**Cc:** Gustafson, Jennifer <jgustafson@da.washoecounty.gov>; Smith, Dwayne E. <DESmith@washoecounty.gov>; EHS Plan Review <EHSPanReview@washoecounty.gov>; Lloyd, Trevor <TLloyd@washoecounty.gov>; Emerson, Kathy <KEmerson@washoecounty.gov>; Albarran, Adriana <AAlbarran@washoecounty.gov>; Oakley, Katherine <KOakley@washoecounty.gov>; Bronczyk, Christopher <CBronczyk@washoecounty.gov>

**Subject:** November Agency Review Memo I

Good afternoon,



**WASHOE COUNTY**  
**COMMUNITY SERVICES DEPARTMENT**  
**Regional Parks and Open Space**

1001 EAST 9<sup>TH</sup> STREET  
 RENO, NEVADA 89520-0027  
 PHONE (775) 328-3600  
 FAX (775) 328.3699

---

**TO:** Katherine Oakley, Planner

**FROM:** Faye-Marie Pekar, Park Planner

**DATE:** December 15, 2022

**SUBJECT:** Special Use Permit Case Number WSUP22-0035 (North Valley Solar PRS)

---



I have reviewed the application for case number WSUP22-0035 (North Valley Solar PRS) on behalf of the Washoe County Regional Parks and Open Space Program (Parks Program) and prepared the following comments:

If approved, this special use permit would allow for the construction of a 5.5 MW photovoltaic solar field ±14 miles south of Empire, Nevada. Project activities would include: ±4.65 acres of disturbance and ±4,200 cubic yards of fill. In order to comply with Open Space and Natural Resource Management Plan (OSNRMP) Natural Hazards Policy 2.6, High Desert Area Plan Policy 6.4, and Washoe County Master Plan Conservation Element Policy C.5.3, Washoe County Parks requires the following conditions of approval:

1. All earthen material imported as part of this project is required to be “certified weed free” in order to prevent the spread of noxious weeds within the county.
2. Prior to the issuance of building/grading permits, the applicant shall update the existing revegetation plan for the overall project (WSUP20-013 Ormat Geothermal) to include the new proposed disturbance area from the current proposal (WSUP22-0035). Revegetation is required for all temporary disturbance areas. Revegetation plan shall be prepared by a biologist or other qualified professional, to Washoe County Parks for review and approval. At a minimum, the plan will include: existing site conditions; the area of impact; restoration goals; selection of native/perennial adapted plants or seed mixes; revegetation methods; measures to prevent the spread of noxious weeds; revegetation success criteria; and appropriate monitoring provisions.



## Public Notice

Pursuant to Washoe County Code Section 110.306.25 public notification consists of notification by mail of at least 30 separate property owners within a minimum 500-foot radius of the subject property. This proposal was noticed within a 99,500-foot radius of the subject property, noticing 38 separate property owners.



# Special Use Permit Application North Valley Geothermal Solar Project

Submitted to Washoe County  
November 8, 2022

ORIGINAL

WSUP22-0035  
NORTH VALLEY SOLAR  
EXHIBIT D

Prepared for

ORNI 36, LLC  
6140 Plumas Street  
Reno, NV 89519

Prepared by



**WOOD RODGERS**

BUILDING RELATIONSHIPS ONE PROJECT AT A TIME

1361 Corporate Blvd • Reno, NV 89502 • Tel: 775.823.4068 • www.woodrogers.com

---

## Table of Contents

### Section 1

- ❖ Washoe County Development Application
  - Owner Affidavit
  - Proof of Property Tax

### Section 2

- ❖ Project Description
  - Executive Summary
  - Background
  - Project Location
  - Master Plan and Zoning
  - Project Request
  - Project Details
    - Traffic
    - Grading
    - Water, Sewer, Utilities
    - Landscaping & Screening
- ❖ Findings

### Section 3

- ❖ Maps
  - Vicinity Map
  - Aerial Map
  - Master Plan Map
  - Zoning Map
  - Reduced Civil Site Plan

### Map Pocket

- ❖ Site Plans (full size)



# Section 1

## Washoe County Development Application

Your entire application is a public record. If you have a concern about releasing personal information, please contact Planning and Building staff at 775.328.6100.

|                                                                                                                                                                                 |                 |                                       |                 |
|---------------------------------------------------------------------------------------------------------------------------------------------------------------------------------|-----------------|---------------------------------------|-----------------|
| <b>Project Information</b>                                                                                                                                                      |                 | Staff Assigned Case No.: _____        |                 |
| Project Name: <b>North Valley Geothermal Solar Project</b>                                                                                                                      |                 |                                       |                 |
| Project Description: Installation of a 5.5 MW photo voltaic solar field for energy production to support the adjacent geothermal facility previously approved by Washoe County. |                 |                                       |                 |
| Project Address: 0 Unspecified Washoe County                                                                                                                                    |                 |                                       |                 |
| Project Area (acres or square feet): 323 acres                                                                                                                                  |                 |                                       |                 |
| Project Location (with point of reference to major cross streets <b>AND</b> area locator):<br><b>Approximately 10 miles north of Pyramid Lake</b>                               |                 |                                       |                 |
| Assessor's Parcel No.(s):                                                                                                                                                       | Parcel Acreage: | Assessor's Parcel No.(s):             | Parcel Acreage: |
| 071-070-12                                                                                                                                                                      | 163             | 071-070-13                            | 160             |
| Indicate any previous Washoe County approvals associated with this application:<br>Case No.(s). WSUP20-0013 (Ormat Geothermal)                                                  |                 |                                       |                 |
| <b>Applicant Information</b> (attach additional sheets if necessary)                                                                                                            |                 |                                       |                 |
| <b>Property Owner:</b>                                                                                                                                                          |                 | <b>Professional Consultant:</b>       |                 |
| Name: Kosmos Company                                                                                                                                                            |                 | Name: Wood Rodgers, Inc               |                 |
| Address: 601 Union St. Ste 3900                                                                                                                                                 |                 | Address: 1361 Corporate Blvd          |                 |
| Seattle, WA                                                                                                                                                                     | Zip: 98101      | Reno, NV                              | Zip: 89502      |
| Phone: 206-624-8111                                                                                                                                                             | Fax:            | Phone: 775-823-5258                   | Fax:            |
| Email: chris.kosmos@kosmosllc.com                                                                                                                                               |                 | Email: shuggins@woodrogers.com        |                 |
| Cell:                                                                                                                                                                           | Other:          | Cell:                                 | Other:          |
| Contact Person:                                                                                                                                                                 |                 | Contact Person: Stacie Huggins        |                 |
| <b>Applicant/Developer:</b>                                                                                                                                                     |                 | <b>Other Persons to be Contacted:</b> |                 |
| Name: Orni 36, LLC                                                                                                                                                              |                 | Name:                                 |                 |
| Address: 6140 Plumas Street                                                                                                                                                     |                 | Address:                              |                 |
| Reno, NV                                                                                                                                                                        | Zip: 89519      |                                       | Zip:            |
| Phone: 775-356-9029                                                                                                                                                             | Fax:            | Phone:                                | Fax:            |
| Email: efreese@ormat.com                                                                                                                                                        |                 | Email:                                |                 |
| Cell:                                                                                                                                                                           | Other:          | Cell:                                 | Other:          |
| Contact Person: Erica Freese                                                                                                                                                    |                 | Contact Person:                       |                 |
| <b>For Office Use Only</b>                                                                                                                                                      |                 |                                       |                 |
| Date Received:                                                                                                                                                                  | Initial:        | Planning Area:                        |                 |
| County Commission District:                                                                                                                                                     |                 | Master Plan Designation(s):           |                 |
| CAB(s):                                                                                                                                                                         |                 | Regulatory Zoning(s):                 |                 |

**WSUP22-0035  
NORTH VALLEY SOLAR  
EXHIBIT D**

# Special Use Permit Application Supplemental Information

(All required information may be separately attached)

1. What is the project being requested?

Installation of a 5.5 megawatt photo voltaic solar field for renewable energy production to support the adjacent geothermal facility. Specifically the project includes solar arrays, ancillary buildings, fencing, and roads (refer to Section 2 Project Description for more detailed information).

2. Provide a site plan with all existing and proposed structures (e.g. new structures, roadway improvements, utilities, sanitation, water supply, drainage, parking, signs, etc.)

Refer to Civil Plans in map pocket

3. What is the intended phasing schedule for the construction and completion of the project?

The project is anticipated to be constructed in a single phase and will take up to 6 months. The Applicant hopes to begin construction in March 2023.

4. What physical characteristics of your location and/or premises are especially suited to deal with the impacts and the intensity of your proposed use?

The project site is primarily undeveloped flat land immediately adjacent to a recently approved geothermal facility that is under construction. Based on the location and the area surrounding the site, impacts are anticipated to be minimal.

5. What are the anticipated beneficial aspects or affects your project will have on adjacent properties and the community?

The proposed solar project is immediately adjacent to a geothermal plant under construction and operated by the Applicant. As such, the proposed renewable energy production project (ie - solar) will provide a reliable source of power for the plant that requires minimal off-site infrastructure.

6. What are the anticipated negative impacts or affect your project will have on adjacent properties? How will you mitigate these impacts?

The proposed project is not anticipated to have negative impacts on adjacent properties given that the site is surrounded by vacant land or land under construction for the geothermal plant. Furthermore, the project has been designed to minimize impacts on the surrounding areas by limiting the footprint of the solar project and providing fencing around the project perimeter.

7. Provide specific information on landscaping, parking, type of signs and lighting, and all other code requirements pertinent to the type of use being purposed. Show and indicate these requirements on submitted drawings with the application.

Given the surrounding area and in keeping with the High Desert Area Plan, the applicant is seeking to vary from WC Code in terms of parking and landscaping. Refer to the Project Description for detailed discussion.

8. Are there any restrictive covenants, recorded conditions, or deed restrictions (CC&Rs) that apply to the area subject to the special use permit request? (If so, please attach a copy.)

|                              |                                        |
|------------------------------|----------------------------------------|
| <input type="checkbox"/> Yes | <input checked="" type="checkbox"/> No |
|------------------------------|----------------------------------------|

9. Utilities:

|                                 |               |
|---------------------------------|---------------|
| a. Sewer Service                | N/A           |
| b. Electrical Service           | Ormat         |
| c. Telephone Service            | AT&T          |
| d. LPG or Natural Gas Service   | N/A           |
| e. Solid Waste Disposal Service | N/A           |
| f. Cable Television Service     | N/A           |
| g. Water Service                | Private Wells |

For most uses, Washoe County Code, Chapter 110, Article 422, Water and Sewer Resource Requirements, requires the dedication of water rights to Washoe County. Please indicate the type and quantity of water rights you have available should dedication be required.

|                    |  |                    |  |
|--------------------|--|--------------------|--|
| h. Permit #        |  | acre-feet per year |  |
| i. Certificate #   |  | acre-feet per year |  |
| j. Surface Claim # |  | acre-feet per year |  |
| k. Other #         |  | acre-feet per year |  |

Title of those rights (as filed with the State Engineer in the Division of Water Resources of the Department of Conservation and Natural Resources).

10. Community Services (provided and nearest facility):

|                         |                                                 |
|-------------------------|-------------------------------------------------|
| a. Fire Station         | Washoe County Fire Station 242; 8.5 miles north |
| b. Health Care Facility | Banner Health Center; 78 miles south (Fernley)  |
| c. Elementary School    | N/A                                             |
| d. Middle School        | N/A                                             |
| e. High School          | N/A                                             |
| f. Parks                | N/A                                             |
| g. Library              | N/A                                             |
| h. Citifare Bus Stop    | N/A                                             |

**Special Use Permit Application  
for Grading  
Supplemental Information**  
(All required information may be separately attached)

1. What is the purpose of the grading?

Installation of access roads for equipment maintenance and emergency access.

2. How many cubic yards of material are you proposing to excavate on site?

Little to no excavation is proposed as part of this project.

3. How many square feet of surface of the property are you disturbing?

Approximately 202,500 square feet is proposed to be disturbed.

4. How many cubic yards of material are you exporting or importing? If none, how are you managing to balance the work on-site?

Earthwork associated with construction of the solar fields will not require import or export. However, an estimated 4,200 CY of Type II class B aggregate base will be imported to construct the IFC compliant access roads.

5. Is it possible to develop your property without surpassing the grading thresholds requiring a Special Use Permit? (Explain fully your answer.)

It is not possible to develop the property without surpassing the grading threshold due to the required roadways that are intended for equipment installation, equipment maintenance, and emergency access.

6. Has any portion of the grading shown on the plan been done previously? (If yes, explain the circumstances, the year the work was done, and who completed the work.)

No portion of the grading shown on the attached civil plans has been done.

7. Have you shown all areas on your site plan that are proposed to be disturbed by grading? (If no, explain your answer.)

Yes, all areas proposed to be disturbed are shown on the attached civil plans.

8. Can the disturbed area be seen from off-site? If yes, from which directions and which properties or roadways?

The site is very flat and can likely be seen from all directions; however, the site is planned to be screened by fencing and is also adjacent to property currently being leased by the Applicant for a geothermal plant.

9. Could neighboring properties also be served by the proposed access/grading requested (i.e. if you are creating a driveway, would it be used for access to additional neighboring properties)?

The proposed project will not serve anyone other than the Applicant.

10. What is the slope (horizontal/vertical) of the cut and fill areas proposed to be? What methods will be used to prevent erosion until the revegetation is established?

Slopes will not exceed 3:1. As shown on the plans, the only slopes planned are catch slopes on the sides of the roadway(s). Silt fencing, wind erosion and dust control (water trucks) and rock filter berms will be used if sufficient vegetation and surface rocky material is present (refer to sheet C0.2 for reference).

11. Are you planning any berms?

|     |                                        |                                              |
|-----|----------------------------------------|----------------------------------------------|
| Yes | No <input checked="" type="checkbox"/> | If yes, how tall is the berm at its highest? |
|-----|----------------------------------------|----------------------------------------------|

12. If your property slopes and you are leveling a pad for a building, are retaining walls going to be required? If so, how high will the walls be and what is their construction (i.e. rockery, concrete, timber, manufactured block)?

N/A

13. What are you proposing for visual mitigation of the work?

The entire project site will be fenced with a 6 foot tall fence with 3 strand barb wire on top (refer to Civil Detail sheet).

14. Will the grading proposed require removal of any trees? If so, what species, how many and of what size?

N/A

15. What type of revegetation seed mix are you planning to use and how many pounds per acre do you intend to broadcast? Will you use mulch and, if so, what type?

Only incidental disturbance will require reseeding. Disturbance area shown on the plans consists of the roadway and a nominal area associated with the piles and neither are planned to be revegetated.

16. How are you providing temporary irrigation to the disturbed area?

Temporary irrigation will not be provided to the disturbed area; however, water trucks will be available to control dust during construction.

17. Have you reviewed the revegetation plan with the Washoe Storey Conservation District? If yes, have you incorporated their suggestions?

The revegetation plan has not been reviewed with the WSCD at this time.

18. Are there any restrictive covenants, recorded conditions, or deed restrictions (CC&Rs) that may prohibit the requested grading?

|     |                                        |                               |
|-----|----------------------------------------|-------------------------------|
| Yes | No <input checked="" type="checkbox"/> | If yes, please attach a copy. |
|-----|----------------------------------------|-------------------------------|

# Section 2



## Project Description

### Executive Summary

|                 |                                                                                                                                                                                                           |
|-----------------|-----------------------------------------------------------------------------------------------------------------------------------------------------------------------------------------------------------|
| Applicant:      | ORNI 36, LLC                                                                                                                                                                                              |
| APN Numbers:    | 071-070-12 and 071-070-13                                                                                                                                                                                 |
| Request:        | A request has been made for a Special Use Permit for a Renewable Energy Production project that includes a 5.5-megawatt solar field.                                                                      |
| Project Site:   | The Project Site consists of two parcels (APNs 071-070-12 and 071-070-13) located west of State Route 447, approximately 10 miles north of Pyramid Lake, and approximately 19 miles south of Gerlach, NV. |
| Project Area:   | The Project is proposed on 50.18 acres of the 323 acre Project Site.                                                                                                                                      |
| Master Plan:    | Rural (R)                                                                                                                                                                                                 |
| Current Zoning: | General Rural (GR)                                                                                                                                                                                        |

### Background

Currently, the Project Site is primarily undeveloped, flat land immediately adjacent to a recently approved geothermal facility that is under construction. There are no buildings or structures on the subject property. Much of the landcover onsite is low-lying, native plants, which includes shrubs and grasses.

### Project Location

The Washoe County Assessor's office identifies the Project Site as Assessor Parcel Numbers (APNs) 071-070-12 and 071-070-13. The parcels are located west of State Route 447, approximately 19 miles south of Gerlach, NV, and approximately 10 miles north of Pyramid Lake. The proposed Project is planned immediately adjacent to a geothermal plant that is under construction and operated by the Applicant. (*Refer to Vicinity Map and Site Aerial in Section 3 of this submittal packet*)

### Master Plan and Zoning

The Project Site spans two parcels which total approximately 323 acres, however, the specific Project Area planned to be developed is limited to 50.18 acres. Both parcels have a Master Plan designation of Rural (R) and a Zoning designation of General Rural (GR) and are located within the High Desert Area Plan. (*Refer to Existing Master Plan Map and Existing Zoning Map in Section 3 of this submittal packet*).

### Project Request

Included with this application is a Special Use Permit (SUP) to allow for development of a Renewable Energy Production project which is identified as Permitted with a SUP within the GR zoning designation.

It is worth noting that because the Project produces greater than 5 MW of power, it is considered a "Project of Regional Significance" which requires review by the Truckee Meadows Regional Planning Agency.

### Project Details

The proposed project consists of a 5.5-megawatt (MW) solar photovoltaic (PV) generation facility on approximately 50.18± acres of private land that is relatively flat. The Project includes three solar fields, ancillary

buildings, and 20-foot wide all-weather access roads all of which will be enclosed by a 6-foot tall chain link fence with three strand barb wire on top for security purposes.

The proposed solar field will consist of 13,041 PV panels, installed in strings (27 panels per string). Based on the design and number of panels proposed, the total field output is estimated at 5.5MW. Generally, the panel height will be approximately 4.75 ft above ground, unless the panels are fully vertical, then they will be 8.5 ft above ground. The power will be used to supply the in-house loads of the adjacent geothermal plant.

In terms of access, the Project includes a new 20-foot wide private access road planned in the southeast corner of the Project Site, near the geothermal plant, which will serve as the main point of ingress/egress. The access road will include a 24-foot wide sliding access gate with a knock box for emergency fire access. A secondary access with two 12-foot wide swinging access gates is also provided in the northwest corner of the Project Area. Once inside the fenced area, on-site roads will be graded dirt roads or hardened roads up to 20 feet wide (*refer to Detail 3 on Sheet C3.0 of Civil Plans in Map Pocket*).

In terms of ancillary buildings, the Project includes an area in the southeast corner of the Project Site that will primarily serve as an area for vehicle, materials and/or equipment storage. While there may be some parking of vehicles in these areas, no formal parking areas are included. As a part of the SUP, the Applicant is requesting a waiver to eliminate requirements associated with parking and maneuvering areas being paved. The Applicant is requesting that this requirement be waived since paved parking is generally intended for the urban environment and the location of the solar field is remote and does not include services like storm water utilities including curb and gutter which are generally included with the installation of pavement.

The Project is expected to be constructed in a single phase over 5 months with construction anticipated to start in March 2023.

#### Traffic

Based on the type of use proposed, traffic is anticipated to be minimal once construction is complete. During construction, approximately 40 workers will be on site, six days a week for approximately 80 days. Following construction, traffic associated with the solar project will be limited to monthly (or weekly) visits by the Applicant. As noted previously, because these roads will only be used by authorized employees of the Applicant, traffic impacts on the surrounding area are anticipated to be minimal.

#### Grading

Grading activities include clearing of boulders and rocks for solar arrays, ancillary buildings and new roads. Total project disturbance is estimated to be approximately 202,550 square feet. Inside the fenced area, the site will be graded to create a level area for the solar arrays to be installed. Footings will be placed as singular poles with base stabilization. Where grading occurs, it will be revegetated in accordance with an Truckee Meadows Fire Protection District and/or BLM standards.

#### Water, Sewer, & Utilities

The proposed project does not require the use of water (except for dust control during construction), sewer, or other utility services.

Landscaping and Screening

The proposed Project does not include any formal landscaping in accordance with Washoe County Development Code Section 110.412.10 which states that uses classified under the Energy Production, Renewable use type are exempt from landscaping requirements, except for parking and loading areas associated with these uses, and when located at least one mile from a residential dwelling.

As designed, the Project does not include any formal parking or loading areas so no landscaping has been provided. It is worth mentioning that proposing any sort of landscaping on the site would have a negative visual impact on the area and take away from the character of the area since the native vegetation does not include plant types typically found in more formal landscaping, including the use of trees. While no formal landscaping is proposed, the Applicant will meet Washoe County (and BLM) standards for revegetation and stabilization of disturbed areas.

As noted previously, the Applicant is proposing to fence the Project Area with a six-foot tall chain-link fence with 3 strand barb wire on top as shown on the Civil Detail sheet (refer to Civil Plan Set in Map Pocket).

Neighborhood Meeting

The Applicant hosted a neighborhood meeting virtually on October 25, 2022. Notices were sent to 41 property owners within the vicinity. Two people participated in the meeting and asked questions about impacts to water in the area and whether the project would be visible to the public. All information was uploaded to the WC HUB site following the meeting.

### **Special Use Permit Findings**

Below is a summary of the required findings for a special use permit, the Planning Commission, Board of Adjustment, or a hearing examiner shall find that all of the following are true:

**Finding (a) Consistency.** The proposed use is consistent with the action programs, policies, standards and maps of the Master Plan and the applicable area plan;

*Response:* The Project Site has a Master Plan designation of Rural (R) and General Rural (GR) base zoning. In accordance with Washoe County Development Code, the proposed use of Energy Production, Renewable is permitted in this zoning designation with approval of a Special Use Permit. The use is appropriate for the site and has been designed to meet all applicable goals and policies of the Washoe County Master Plan, the High Desert Area Plan and the High Desert Character Management Area.

**Finding (b) Improvements.** Adequate utilities, roadway improvements, sanitation, water supply, drainage, and other necessary facilities have been provided, the proposed improvements are properly related to existing and proposed roadways, and an adequate public facilities determination has been made in accordance with Division Seven;

*Response:* The proposed Project has been designed in accordance with all applicable codes and regulations. All necessary facilities will be provided on site, including a new 20-foot wide access road and on-site roads to serve the project. Given the type of use proposed, the Project is not anticipated to be a large traffic generator that will require additional offsite improvements.

**Finding (c) Site Suitability.** The site is physically suitable for the type of development and for the intensity of development;

*Response:* The Project Site is primarily surrounded by undeveloped land with the exception of a previously approved geothermal plant that is under construction. Given that the Project Site is surrounded by property currently being leased by the Applicant and relatively flat in terms of topography, the site is physically suitable for the proposed use.

**Finding (d) Issuance Not Detrimental.** Issuance of the permit will not be significantly detrimental to the public health, safety or welfare; injurious to the property or improvements of adjacent properties; or detrimental to the character of the surrounding area; and

*Response:* The proposed renewable energy production (ie – solar field) project will not be detrimental to the public health, safety, or welfare or to the character of the surrounding area. The Project is located on private property adjacent to a geothermal plant (operated by the Applicant) that is under construction. As noted previously, all aspects of the proposed Project will be screened by fencing and not visible to the general public.

**Finding (e) Effect on a Military Installation.** Issuance of the permit will not have a detrimental effect on the location, purpose or mission of the military installation.

*Response:* Not applicable to the Project.

# Section 3



**Vicinity Map**  
**North Valley Geothermal Solar Site**  
 November 2022

**WOOD RODGERS**  
 BUILDING RELATIONSHIPS ONE PROJECT AT A TIME  
 1361 Corporate Boulevard Tel: 775.823.4068  
 Reno, NV 89502 Fax: 775.823.4066

J:\Jobs\1707\_Steamboat Hills Geothermal\020\_N.V.\_Solar\_Project\_OA\Planning\Docs\Submittals\SUP\ArcGIS\North Valleys Geothermal Solar Site\North Valleys Geothermal Solar Site.aprx 11/8/2022 10:36 AM kjmoses

071-070-10  
KOSMOS  
COMPANY

071-070-18  
KOSMOS  
COMPANY

071-070-19  
US GEOTHERMAL  
INC



071-070-12  
KOSMOS  
COMPANY

071-070-13  
KOSMOS  
COMPANY

071-030-06  
UNITED STATES  
OF AMERICA

Maxar, Microsoft, Esri Community Maps Contributors, California State Parks, © OpenStreetMap, Microsoft, Esri, HERE, Garmin, SafeGraph, GeoTechnologies, Inc, METI/NASA, USGS, Bureau of Land Management, EPA, NPS, US Census Bureau, USDA

**Legend**

-  Project Area
-  Parcels



# Aerial Map

## North Valley Geothermal Solar Site

November 2022



**WOOD RODGERS**  
BUILDING RELATIONSHIPS ONE PROJECT AT A TIME  
1361 Corporate Boulevard  
Reno, NV 89502  
Tel: 775.823.4068  
Fax: 775.823.4066



**Legend**

- Project Area
- Washoe County Master Plan**
- R - Rural

Esri Community Maps Contributors, California State Parks, Esri, HERE, Garmin, SafeGraph, GeoTechnologies, Inc, METI/NASA, USGS, Bureau of Land Management, EPA, NPS, US Census Bureau, USDA



**Master Plan**  
**North Valley Geothermal Solar Site**  
 November 2022



**WOOD RODGERS**  
 BUILDING RELATIONSHIPS ONE PROJECT AT A TIME  
 1361 Corporate Boulevard Reno, NV 89502  
 Tel: 775.823.4068 Fax: 775.823.4066

J:\Jobs\1707\_Steamboat Hills Geothermal\020\_N.V.\_Solar\_Project\_OA\Planning\Docs\Submittals\SUP\ArcGIS\North Valleys Geothermal Solar Site\North Valleys Geothermal Solar Site.aprx 11/8/2022 10:31 AM kjmoses



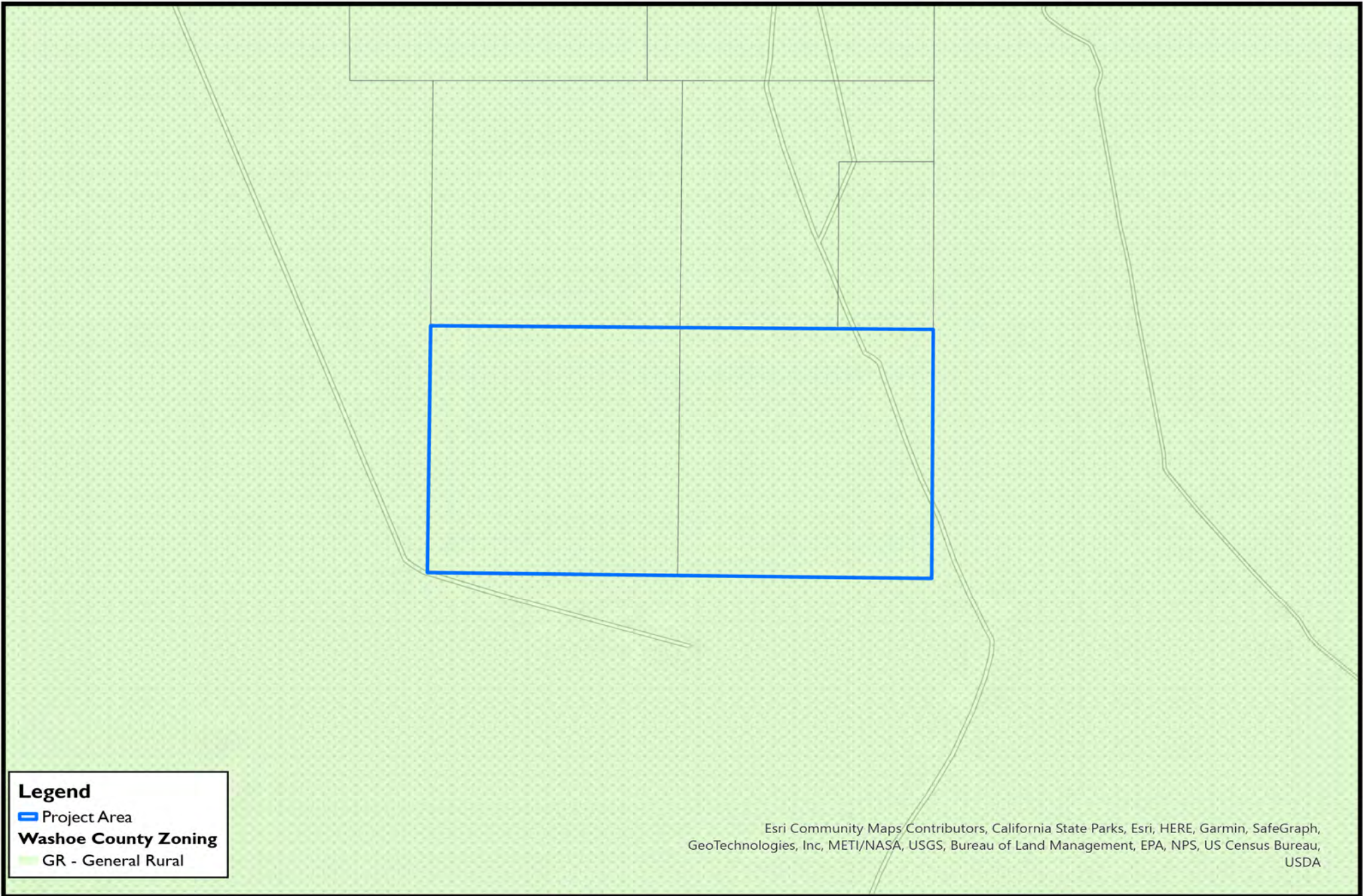

**Legend**

-  Project Area
- Washoe County Zoning**
-  GR - General Rural

Esri Community Maps Contributors, California State Parks, Esri, HERE, Garmin, SafeGraph, GeoTechnologies, Inc, METI/NASA, USGS, Bureau of Land Management, EPA, NPS, US Census Bureau, USDA

**Zoning**  
**North Valley Geothermal Solar Site**  
 November 2022

# NORTH VALLEY SOLAR PLAN CIVIL PLANS

## LAND INFORMATION

COUNTY: WASHOE COUNTY, NEVADA  
ASSESSORS' PARCELS: 071-070-12, 071-070-13  
DESCRIPTION: PORTIONS OF SECTIONS 16 AND 21, T29N R23E MDM

## PROJECT AUTHORITY

**APPLICANT**  
ORMAT NEVADA, INC  
WADE POSTEN, PROJECT MANAGER  
6140 PLUMAS STREET, STE 200  
RENO, NV 89519  
(775) 846-8937  
wposten@ormat.com

**CIVIL ENGINEER**  
ROBISON ENGINEERING COMPANY, INC  
NATHAN EARL ROBISON, PE  
846 VICTORIAN AVE. SUITE 20  
SPARKS, NV 89436  
(775) 852-2251  
(775) 852-9736 FAX  
nathan@robisoneng.com

## SHEET INDEX

C0.0 TITLE PAGE  
C0.1 EXISTING CONDITIONS AND TOPOGRAPHY  
C0.2 EROSION AND SEDIMENT CONTROL PLAN  
C1.0 SITE PLAN  
C1.1 HORIZONTAL CONTROL PLAN  
C2.0 GRADING PLAN  
C3.0 CIVIL DETAILS AND SPECIFICATIONS

## PROJECT NOTES AND SPECIFICATIONS:

**GENERAL**  
1. ALL WORK, PERSONNEL, MATERIALS & EQUIPMENT SHALL CONFORM TO LOCAL GOVERNING CODES, OSHA REQUIREMENTS, AND PROFESSIONAL STANDARDS OF WORKMANSHIP, AND THE STANDARD AND SITE-SPECIFIC SPECIFICATIONS OF ORMAT NEVADA, INC OR ITS REPRESENTATIVE.  
2. NO MAJOR PHASE OF CONSTRUCTION (GROUNDBREAKING, CONCRETE POUR, BURIAL OF UNDERGROUND COMPONENTS, ETC) MAY BE PERFORMED WITHOUT WRITTEN APPROVAL OF ORMAT PROJECT MANAGER WADE POSTEN OR OTHER DESIGNATED RESPONSIBLE INDIVIDUAL WITHIN ORMAT NEVADA, INC. (EMAIL OR TEXT APPROVAL WITH CLEAR SCOPE MAY BE ACCEPTABLE)  
3. SUBMITTALS: THE FOLLOWING SHALL BE PROVIDED TO ORMAT NEVADA AND ROBISON ENGINEERING FOR APPROVAL PRIOR TO THEIR USE IN THIS PROJECT:  
A. IMPORT FILL MATERIALS, INCLUDING BACKFILL AND FINAL GRADE SURFACE AGGREGATES  
B. PORTLAND CEMENT CONCRETE  
4. INSPECTION AND TESTING: ORMAT SHALL PROVIDE CONSTRUCTION OBSERVATION AND CONTRACTOR SHALL PROVIDE OPPORTUNITY FOR INSPECTION, AS-BUILT SURVEY, ETC AT ALL TIMES DURING THE PROJECT.

**DESIGN CRITERIA**  
1. SEE ORMAT PROJECT MANUAL, INCLUDING BUT NOT LIMITED TO THE FOLLOWING SPECIFICATIONS:  
A. 7,000.SP.001.2 - SITE PREP AND GRADING  
B. 7,000.SP.002.2 - TRENCHING BACKFILL AND COMPACTION  
C. 7,000.SP.004.2 - SEEDING AND SITE RESTORATION  
5. NATIVE SITE SOIL AFTER GRUBBING AND MASS GRADING IS EXPECTED TO BE APPROPRIATE FOR THE FINAL SUBGRADE OF PLANT AND ROADS. SURFACE COURSE (4" MINIMUM) SHALL CONSIST OF CLEAN-SOURCED GRAVEL CONFORMING TO THE FOLLOWING GRADATION:  
MAX SIZE: 1.5"  
50% PASSING 1" SCREEN  
<15% PASSING #200 SCREEN  
IF CUT/FILL PLANT SITE MATERIAL IS NOT GRANULAR SAND AND GRAVEL, CONTACT ENGINEER  
6. SEE ADDITIONAL NOTES AND SPECIFICATIONS SHEET CD1.

**GENERAL NOTES**  
1. THESE PLANS HAVE BEEN PREPARED IN ACCORDANCE WITH ACCEPTED ENGINEERING PROCEDURES AND GUIDELINES, AND ARE BELIEVED TO BE IN SUBSTANTIAL COMPLIANCE WITH APPLICABLE STATUTES, AND ORDINANCES OR STANDARDS SPECIFIED BY THE PERMITTING JURISDICTION. IN THE EVENT OF A CONFLICT BETWEEN ANY PORTION OF THESE PLANS AND PERMITTING STANDARDS, PROMPTLY NOTIFY ENGINEER, OR ADOPT THE MORE CONSERVATIVE STANDARD CONSISTENT WITH THE INTENT OF THE PLANS. IN ACCORDANCE WITH GENERALLY ACCEPTED CONSTRUCTION PRACTICES, CONTRACTOR BEARS SOLE AND COMPLETE RESPONSIBILITY FOR JOB SITE CONDITIONS DURING THE COURSE OF CONSTRUCTION, INCLUDING SAFETY OF ALL PERSONS AND PROPERTY.  
2. IF THE CONTRACTOR(S) OBSERVES ANY CONDITION ON THE SITE WHICH CONFLICTS WITH THE INFORMATION SHOWN HEREON, THEY SHALL CONTACT ROBISON ENGINEERING AT 775-852-2251 FOR RESOLUTION.  
3. THE ENGINEER SHALL NOT BE RESPONSIBLE OR LIABLE FOR UNAUTHORIZED CHANGES TO OR USES OF THESE PLANS. ALL CHANGES TO THE PLANS MUST BE IN WRITING AND MUST BE APPROVED BY THE ENGINEER.  
4. IN THE EVENT ELECTRONIC FILES (CAD, ETC) ARE PROVIDED BY ROBISON ENGINEERING, AN INDEMNIFICATION AGREEMENT IS IMPLIED BY THAT USE, AND IF THERE IS ANY CONFLICT BETWEEN ELECTRONIC DATA AND THE STAMPED/PERMIT PLAN SET, THE STAMPED DRAWINGS SHALL GOVERN AND DIRECT THE WORK. IT IS THE SOLE RESPONSIBILITY OF THE CLIENT TO ACQUIRE APPROVED PLANS FROM THE GOVERNING JURISDICTION.  
5. THE CONTRACTOR SHALL VERIFY IN FIELD, ALL ELEVATIONS, DIMENSIONS, FLOW LINES EXISTING CONDITIONS, AND POINTS OF CONNECTIONS WITH ADJOINING PROPERTY (PUBLIC OR PRIVATE). ANY DISCREPANCIES SHALL BE CALLED TO THE ATTENTION OF THE ENGINEER BEFORE PROCEEDING WITH THE WORK.  
6. CONTRACTOR SHALL CONTACT "USA NORTH 811" BY CALLING THAT NUMBER (8-1-1) NO LESS THAN 2 WORKING DAYS BEFORE EXCAVATION IS PROPOSED TO BEGIN, SHALL COMPLY WITH AREA MARKING, ETC.  
7. ALL NATURAL VEGETATION OUTSIDE OF DISTURBANCE LIMITS TO BE PRESERVED. DISTURBED EARTH ALONG TRENCH LINES SHALL RECEIVE GRUBBED VEGETATION MULCH TO REDUCE EROSION AND VISUAL IMPACT. AT BLM'S DIRECTION, SELECTED DISTURBED AREAS MAY REQUIRE BROADCAST-SEEDING AND RAKING DURING OCTOBER-NOVEMBER, OR HYDROSEEDING IN COORDINATION WITH, AND SUBJECT TO APPROVAL BY US BLM.  
8. SHOULD ANY PREHISTORIC OR HISTORIC REMAINS/ARTIFACTS BE DISCOVERED DURING SITE DEVELOPMENT, WORK SHALL TEMPORARILY BE HALTED AT THE SPECIFIC SITE AND THE STATE HISTORIC PRESERVATION DEPARTMENT OF THE DEPARTMENT OF MUSEUMS, LIBRARY AND ARTS SHALL BE NOTIFIED TO RECORD AND PHOTOGRAPH THE SITE. THE PERIOD OF TEMPORARY DELAY SHALL BE LIMITED TO A MAXIMUM OF TWO (2) WORKING DAYS FROM THE DATE OF NOTIFICATION.

**EROSION CONTROL NOTES**  
1. TOTAL DISTURBANCE AREA WILL EXCEED 1 ACRE, THEREFORE A SITE-SPECIFIC STORMWATER POLLUTION PREVENTION PLAN (SWPPP) IS REQUIRED. THE CONTRACTOR SHALL BE AWARE OF AND EXERCISE DUE EFFORT TO CONFORM TO AT LEAST:  
- THE STATE OF NEVADA GENERAL PERMIT NVR100000  
- US BLM WEED AND EROSION CONTROL STANDARDS  
- WASHOE COUNTY STORMWATER PROTECTION ORDINANCES AND STANDARDS.  
2. ADDITIONAL CONSTRUCTION SITE DISCHARGE BEST MANAGEMENT PRACTICES MAY BE REQUIRED OF THE OWNER AND HIS OR HER AGENTS DUE TO UNFORESEEN EROSION PROBLEMS OR AS MANDATED BY BLM CONSTRUCTION STANDARDS.

**SURVEY NOTES**  
1. THIS PLAN IS PREPARED TO ILLUSTRATE TOPOGRAPHY AND FEATURES FOR ENGINEERING PLANNING AND DESIGN ONLY. NO INFORMATION SHALL BE CONSTRUED TO REPRESENT A FORMAL SURVEY OF THE SUBJECT PROPERTY.  
2. BASIS OF BEARINGS IS THE NEVADA STATE PLANE, WEST ZONE, NAD83 BASED ON REF.1 - SEE POINTS LIST SHEET C0.1.  
3. BASIS OF ELEVATIONS IS NAVD88 BASED ON REF.1 - SEE POINTS LIST SHEET C0.1.



**SITE OVERVIEW**

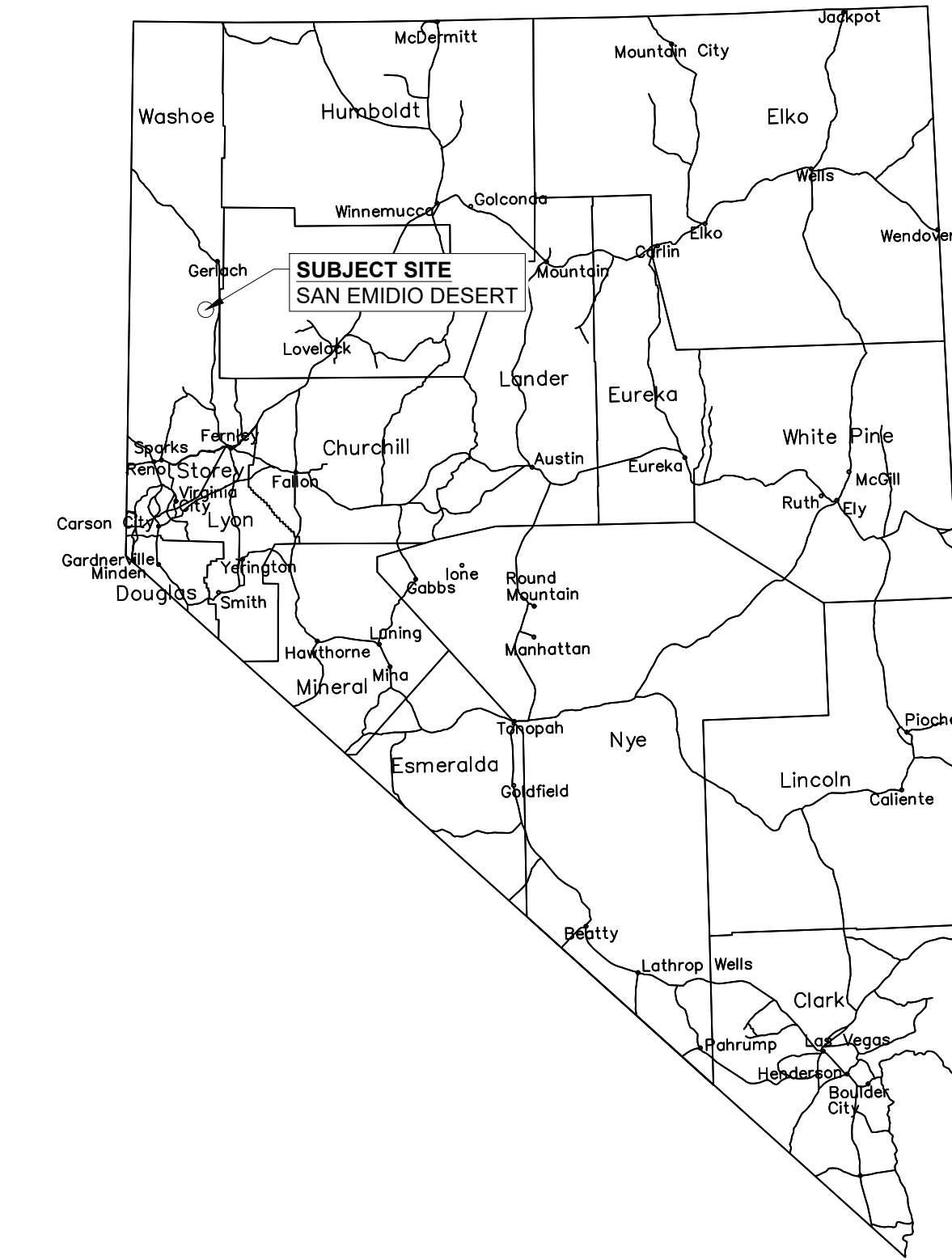

**NEVADA STATE MAP**

## ABBREVIATIONS

|         |                                       |       |                                      |
|---------|---------------------------------------|-------|--------------------------------------|
| Δ       | DELTA                                 | NDOT  | NV DEPT. OF TRANSPORTATION           |
| AC      | ASPHALT CONCRETE                      | OHE   | OVERHEAD ELECTRICAL                  |
| APN     | ASSESSOR'S PARCEL NO.                 | (P)   | PROPOSED                             |
| ASTM    | AMERICAN SOCIETY OF TESTING MATERIALS | PC    | POINT OF CURVATURE                   |
| BLM     | BUREAU OF LAND MANAGEMENT             | PCC   | PORTLAND CEMENT CONCRETE             |
| BMP     | BEST MANAGEMENT PRACTICES             | PL    | PROPERTY LINE                        |
| BSW/BOW | BACK OF WALK                          | PIV   | PRESSURE INDICATOR VALVE             |
| CMP     | CORRUGATED METAL PIPE                 | POC   | POINT OF CONNECTION                  |
| COTG    | CLEAN OUT TO GRADE                    | PT    | POINT OF TANGENCY                    |
| CL      | CENTER LINE                           | PUE   | PUBLIC UTILITY EASEMENT              |
| CY      | CUBIC YARDS                           | PVC   | POLYVINYL CHLORIDE                   |
| (E)     | EXISTING                              | RB    | REBAR                                |
| EG      | EXISTING GRADE                        | RENG  | ROBISON ENGINEERING CO., INC         |
| FDC     | FIRE DEPT. CONNECTION                 | ROW   | RIGHT-OF-WAY                         |
| FFC     | FRONT FACE OF CURB                    | SEC   | SECTION                              |
| FFE     | FINISH FLOOR ELEVATION                | SD    | STORM DRAIN                          |
| FG      | FINISH GRADE                          | SDR   | STD. DIMENSION RATIO                 |
| FH      | FIRE HYDRANT                          | SF    | SQUARE FEET                          |
| FL      | FLOW LINE                             | SS    | SANITARY SEWER                       |
| GA      | GAUGE                                 | STA   | STATION                              |
| GCP     | GROUND CONTROL POINT                  | SWPPP | STORMWATER POLLUTION PREVENTION PLAN |
| H       | HORIZONTAL                            | TC    | TOP OF CURB                          |
| HDPE    | HIGH DENSITY POLYETHYLENE             | TW    | TOP OF WALL                          |
| IAR     | INTERNAL ACCESS ROAD                  | TYP   | TYPICAL                              |
| IE      | INVERT ELEVATION                      | UAS   | UNMANNED AERIAL SURVEY               |
| LF      | LINEAR FEET                           | UNO   | UNLESS NOTED OTHERWISE               |
| MAR     | MAIN ACCESS ROAD                      | US    | UNITED STATES                        |
| MAX     | MAXIMUM                               | V     | VERTICAL                             |
| MDD     | MAXIMUM DRY DENSITY                   | WACO  | WASHOE COUNTY                        |
| MW      | MEGA WATT                             | YH    | YARD HYDRANT                         |

NORTH VALLEY SOLAR PLAN  
**CIVIL PLANS**  
 SHEET C0.0  
 TITLE SHEET  
 WASHOE COUNTY  
 PROJECT NO. 1-0184-31.007  
 NEVADA

PREPARED FOR:  
**ORMAT**  
 NV, INC.  
 6140 PLUMAS ST, ST 200  
 RENO, NV 89519  
 (775) 356-9029

**Robison Engineering**  
 846 VICTORIAN AVENUE  
 SPARKS, NV 89436  
 (775) 852-2251  
 DRAWN: SSJ  
 DATE: PENDING

**PRELIMINARY**  
**NOT FOR**  
**CONSTRUCTION**

| NO | DESCRIPTION                  | DATE | BY | CHK'D |
|----|------------------------------|------|----|-------|
| 1  | RENG UAS TOPO - 2022-03-02   |      |    |       |
| 2  | WASHOE COUNTY OPEN DATA      |      |    |       |
| 3  | ORMAT LAYOUT - 2021-11-21    |      |    |       |
| 4  | US BLM SURVEY #4323          |      |    |       |
| 5  | SOLARGIK - ARRAY LAYOUT REV1 |      |    |       |
| 6  |                              |      |    |       |
| 7  |                              |      |    |       |
| 8  |                              |      |    |       |

| REFERENCES |                     |            |     |       |
|------------|---------------------|------------|-----|-------|
| NO         | DESCRIPTION         | DATE       | BY  | CHK'D |
| P1         | FOR CLIENT REVIEW   | PENDING    | SSJ | NER   |
| P2         | FOR CLIENT REVIEW   | 2022-03-22 | SSJ | NER   |
| P3         | FOR CLIENT REVIEW   | 2022-07-28 | SSJ | NER   |
| P4         | REVISED ACCESS ROAD | 2022-08-09 | SSJ | NER   |
| P5         | FOR CLIENT REVIEW   | 2022-10-25 | SSJ | NER   |

| REVISIONS |  |  |  |  |
|-----------|--|--|--|--|
|           |  |  |  |  |
|           |  |  |  |  |
|           |  |  |  |  |

APPROVALS  
**C0.0**  
SHEET 1 OF 7

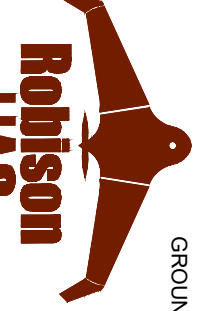

**Robison UAS**  
 846 VICTORIAN AVENUE  
 SPARKS, NV 89431  
 (775) 852-2251  
 www.robisoneng.com

GROUND SCALE DISTANCE: 7 INCH  
 GROUND SURVEY: C. BAXTER  
 COMPILED BY: K. SICKLER

PHOTO DATE: MARCH 2ND 2022

CLIENT: ORMAT NEVADA, INC  
 PROJECT NAME: NORTH VALLEY UAS  
 REVISION PROJECT #: 1-184-31.007

WASHOE COUNTY

| POINT NO. | NORTHING      | EASTING      | POINT ELEV. | DESCRIPTION   |
|-----------|---------------|--------------|-------------|---------------|
| 1007      | 15172415.7317 | 2395957.5000 | 4118.78     | 1/4 sec 16/23 |
| 2003      | 15172442.2532 | 2395995.9308 | 4055.38     | 1/4 sec 16/23 |
| 2101      | 15172505.0182 | 2396072.8812 | 4052.50     | 1/4 sec 16/23 |
| 2102      | 15172518.9189 | 2396271.2879 | 4057.20     | 1/4 sec 16/23 |
| 2103      | 15172528.6375 | 2394738.2048 | 4050.25     | 1/4 sec 16/23 |
| 2105      | 15172931.5186 | 2395732.8221 | 4056.34     | 1/4 sec 16/23 |
| 2106      | 15173159.9876 | 2395230.8887 | 4052.57     | 1/4 sec 16/23 |

**MERGED IMAGERY NOTE:**  
 BACKGROUND IMAGE FROM PUBLIC SOURCE. MAY NOT MEET MAP ACCURACY STANDARDS OUTSIDE OF SURVEY AREA.

**PROPERTY NOTES:**  
 THIS MAP SHALL NOT BE CONSTRUED TO REPRESENT A FORMAL SURVEY OR TO RENDER ANY OPINION THEREON.

**GEOTHERMAL PLANT IN CONSTRUCTION PER SEPARATE PERMIT #**



**LEGEND:**

|  |                   |
|--|-------------------|
|  | PROPERTY BOUNDARY |
|  | PLSS BOUNDARY     |
|  | (E) MAJOR CONTOUR |
|  | (E) MINOR CONTOUR |
|  | (E) CL            |
|  | (E) ACCESS ROAD   |
|  | (E) PIPELINE      |
|  | (E) FLOW LINE     |
|  | (E) STRUCTURE     |
|  | (E) WELL          |
|  | (E) CONTROL POINT |
|  | (E) PLSS CORNER   |

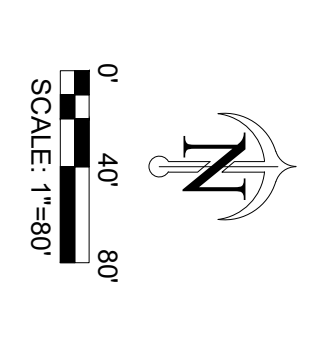

| NO | DESCRIPTION         | DATE       | BY  | CHK'D |
|----|---------------------|------------|-----|-------|
| P1 | FOR CLIENT REVIEW   | PENDING    | SSJ | NER   |
| P2 | FOR CLIENT REVIEW   | 2022-03-22 | SSJ | -     |
| P3 | FOR CLIENT REVIEW   | 2022-07-28 | SSJ | NER   |
| P4 | REVISED ACCESS ROAD | 2022-09-09 | SSJ | NER   |
| P5 | FOR CLIENT REVIEW   | 2022-10-25 | SSJ | NER   |

| NO | DESCRIPTION                  | DATE | BY | CHK'D |
|----|------------------------------|------|----|-------|
| 1  | RENG UAS TOPO - 2022-03-02   |      |    |       |
| 2  | WASHOE COUNTY OPEN DATA      |      |    |       |
| 3  | ORMAT LAYOUT - 2021-11-21    |      |    |       |
| 4  | US BLM SURVEY #4323          |      |    |       |
| 5  | SOLARGIK - ARRAY LAYOUT REV1 |      |    |       |
| 6  |                              |      |    |       |
| 7  |                              |      |    |       |
| 8  |                              |      |    |       |

**PRELIMINARY**  
**NOT FOR**  
**CONSTRUCTION**



846 VICTORIAN AVENUE  
 SPARKS, NV 89431  
 www.robisoneng.com  
 (775) 852-2251

DRAWN: SSJ  
 DATE: PENDING

PREPARED FOR:  
**ORMAT NV, INC.**

6140 PLUMAS ST. ST 200  
 RENO, NV 89519  
 (775) 356-9029

THE WET-STAMPED AND PERMITTED/RECORDED COPY OF THIS PLAN SUPERCEDES ALL OTHER VERSIONS, INCLUDING COPIES AND ELECTRONIC DATA. SEE PROJECT NOTES AND CONTRACT AGREEMENT.

0" 1/2" 1"  
 INCH=FULL SCALE

**NORTH VALLEY SOLAR PLAN**  
**CIVIL PLANS**

SHEET C0.1  
 EXISTING CONDITIONS AND TOPOGRAPHY

WASHOE COUNTY NEVADA  
 PROJECT NO: 1-0184-31.007

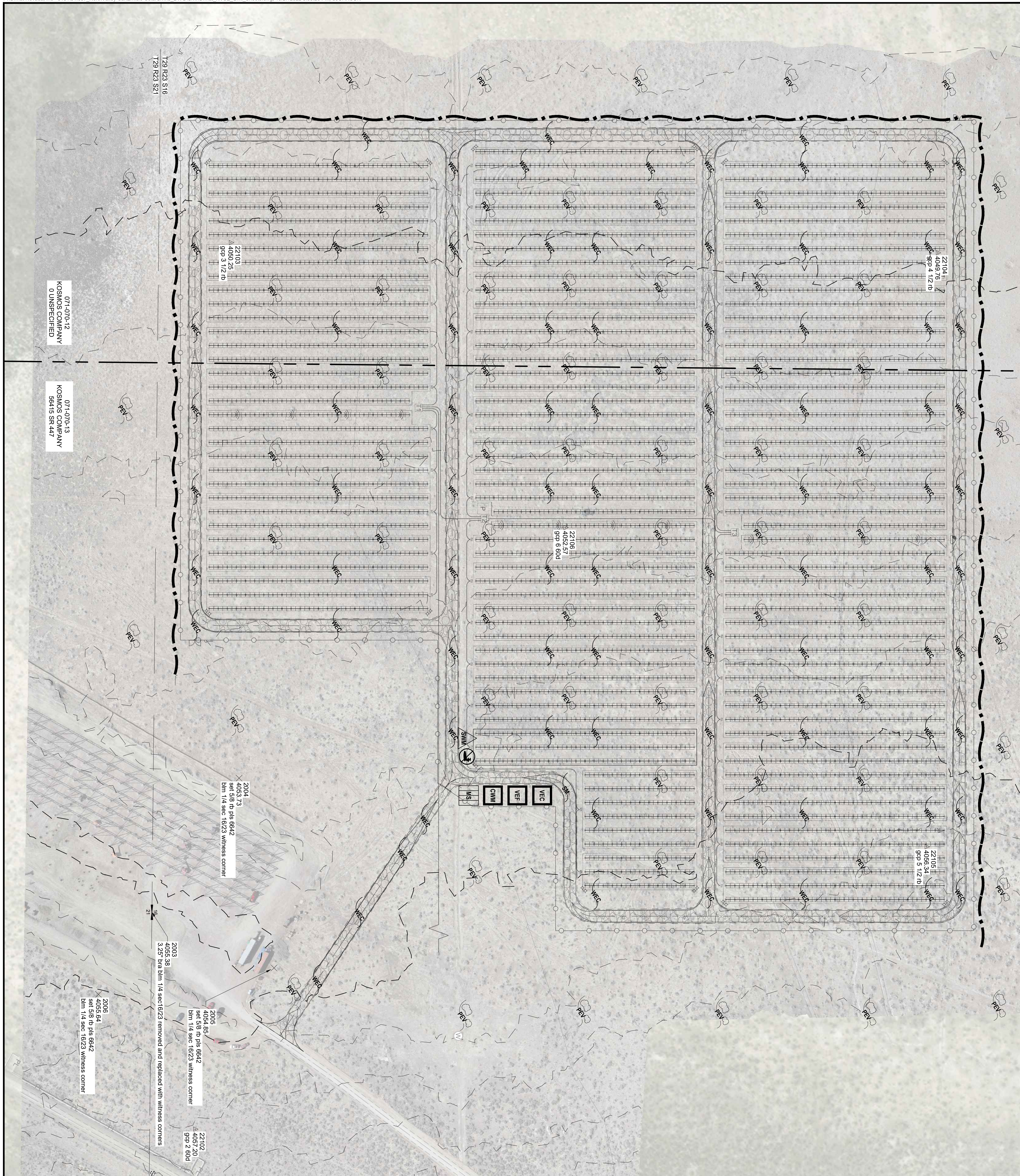

| EROSION CONTROL/BMP LEGEND:                                        |            |            |
|--------------------------------------------------------------------|------------|------------|
| BMP NAME                                                           | BMP NUMBER | MAP SYMBOL |
| TEMPORARY DIVERSION DICES AND DITCHES                              | RC-2       | TD0        |
| CHECK DAMS                                                         | RC-3       | TD0        |
| TEMPORARY SLOPE DRAINS                                             | RC-4       | TS0        |
| PRESERVING EXISTING VEGETATION                                     | EC-1       | PEI        |
| SLOPE TERRACING AND TRACKING                                       | EC-2       | SIT        |
| MULCHING                                                           | EC-3       | MT         |
| SOIL BINDERS                                                       | EC-4       | SB         |
| WIND EROSION AND DUST CONTROL                                      | EC-5       | WEC        |
| ROLLED EROSION CONTROL PRODUCTS                                    | EC-6       | RECP       |
| RR RAP                                                             | EC-7       | RR         |
| RESEEDING                                                          | EC-8       | RE         |
| FIBER ROLLS                                                        | SC-1       | FR         |
| BRUSH AND ROCK FILTERS                                             | SC-2       | BR         |
| SAND BAG BARRIERS                                                  | SC-3       | SB         |
| GRAVEL FILTER BERM                                                 | SC-4       | GB         |
| SILT FENCES                                                        | SC-5       | GF         |
| TEMPORARY SEDIMENT TRAPS                                           | SC-6       | ST         |
| SEWAGE RETENTION BASINS                                            | SC-7       | SR         |
| CONSTRUCTION SITE ENTRANCES AND EXITS                              | SC-8       | SE         |
| CONSTRUCTION EXIT                                                  | SC-9       | SE         |
| THE MASH                                                           | SC-9       | SE         |
| STABILIZED CONSTRUCTION ROADWAY                                    | SC-10      | SR         |
| CROSSING TEMPORARY STREAM                                          | DP-1       | DP         |
| STORMWATER OUTLET PROTECTION                                       | DP-2       | DP         |
| STORMWATER PROTECTION                                              | DP-3       | DP         |
| STOCKPILE MANAGEMENT                                               | GM-2       | SM         |
| SOLID AND DEMOLITION WASTE MANAGEMENT                              | GM-3       | SWM        |
| DEMATERING OPERATIONS                                              | GM-4       | DM         |
| STREET SWEENING                                                    | GM-5       | SW         |
| VEHICLE AND EQUIPMENT AND HEELING                                  | GM-7       | VE         |
| VEHICLE AND EQUIPMENT HANDLING AND DISPOSAL OF CONCRETE AND CEMENT | GM-9       | VE         |
| MATERIAL DELIVERY, HANDLING, STORAGE AND USE                       | GM-10      | MS         |

**SHEET NOTES:**  
 1. LEGEND, SYMBOLS, AND BMP NUMBERS INHERENTLY INCLUDE THE CORRESPONDING DETAILS AND SECTIONS OF THE TRUCKEE MEADOWS CONSTRUCTION SITE BMP HANDBOOK CURRENT EDITION.  
 2. WHERE SURFICIENT VEGETATION AND SURFACE ROCKY MATERIAL ARE PRESENT, THE EROSION CONTROL PRODUCTS MAY BE USED TO REPLACE THE FUNCTION OF SILT FENCE MATERIAL, SUBJECT TO INSPECTION BY ORMAT ENGINEER, AND NDEP FOR CONTROL OF SEDIMENT DISCHARGE FROM SITE.

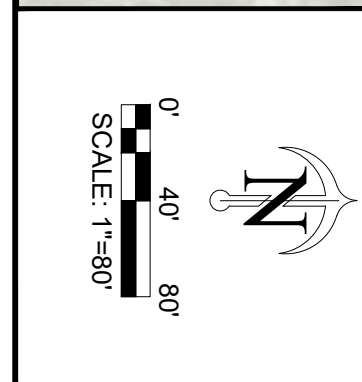

| NO | DESCRIPTION         | DATE       | BY  | CHK'D |
|----|---------------------|------------|-----|-------|
| P1 | FOR CLIENT REVIEW   | PENDING    | SSJ | NER   |
| P2 | FOR CLIENT REVIEW   | 2022-03-22 | SSJ | NER   |
| P3 | FOR CLIENT REVIEW   | 2022-07-28 | SSJ | NER   |
| P4 | REVISED ACCESS ROAD | 2022-09-09 | SSJ | NER   |
| P5 | FOR CLIENT REVIEW   | 2022-10-25 | SSJ | NER   |

| NO | DESCRIPTION                  | DATE | BY | CHK'D |
|----|------------------------------|------|----|-------|
| 1  | RENG UAS TOPO - 2022-03-02   |      |    |       |
| 2  | WASHOE COUNTY OPEN DATA      |      |    |       |
| 3  | ORMAT LAYOUT - 2021-11-21    |      |    |       |
| 4  | US BLM SURVEY #4323          |      |    |       |
| 5  | SOLARGIK - ARRAY LAYOUT REV1 |      |    |       |

**REFERENCES**

**PRELIMINARY  
NOT FOR  
CONSTRUCTION**

846 VICTORIAN AVENUE  
SPARKS, NV 89431  
www.robisoneng.com  
(775) 852-2251

DRAWN: SSJ  
DATE: PENDING

PREPARED FOR:  
**ORMAT NV, INC.**  
6140 PLUMAS ST. ST 200  
RENO, NV 89519  
(775) 356-9029

THE WET-STAMPED AND PERMITTED/RECORDED COPY OF THIS PLAN SUPERCEDES ALL OTHER VERSIONS, INCLUDING COPIES AND ELECTRONIC DATA SEE PROJECT NOTES AND CONTRACT AGREEMENT.

0" = 1/2" = 1"  
INCH=FULL SCALE

**NORTH VALLEY SOLAR PLAN  
CIVIL PLANS**

SHEET C0.2  
EROSION AND SEDIMENT CONTROL PLAN AND BMP PLAN

WASHOE COUNTY  
PROJECT NO: 1-0184-31.007

NEVADA

APPROVALS  
**C0.2**

SHEET 3 OF 7

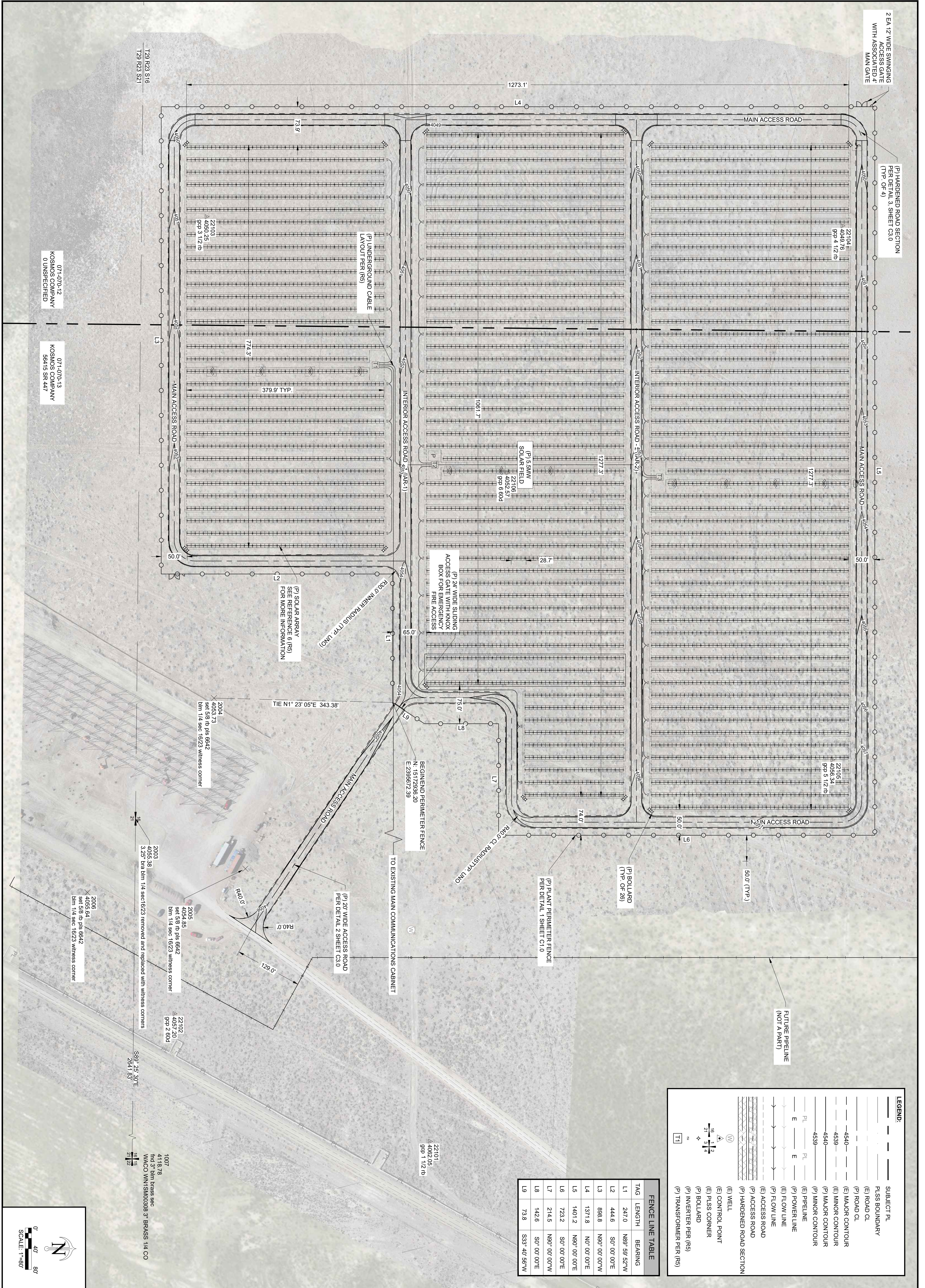

| LEGEND: | SUBJECT PL                |
|---------|---------------------------|
| ---     | PLSS BOUNDARY             |
| ---     | (E) ROAD CL               |
| ---     | (P) ROAD CL               |
| ---     | (E) MAJOR CONTOUR         |
| ---     | (E) MINOR CONTOUR         |
| ---     | (P) MAJOR CONTOUR         |
| ---     | (P) MINOR CONTOUR         |
| ---     | (P) PIPELINE              |
| ---     | (P) POWER LINE            |
| ---     | (E) FLOW LINE             |
| ---     | (P) FLOW LINE             |
| ---     | (E) ACCESS ROAD           |
| ---     | (P) ACCESS ROAD           |
| ---     | (P) HARDENED ROAD SECTION |
| ---     | (E) WELL                  |
| ---     | (E) CONTROL POINT         |
| ---     | (E) PLSS CORNER           |
| ---     | (P) BOLLARD               |
| ---     | (P) INVERTER PER (R9)     |
| ---     | (P) TRANSFORMER PER (R9)  |

| FENCE LINE TABLE | TAG    | LENGTH      | BEARING |
|------------------|--------|-------------|---------|
| L1               | 247.0  | N89°59'52"W |         |
| L2               | 444.6  | S0°00'00"E  |         |
| L3               | 898.8  | N90°00'00"W |         |
| L4               | 1371.8 | N0°00'00"E  |         |
| L5               | 1401.2 | N90°00'00"E |         |
| L6               | 723.2  | S0°00'00"E  |         |
| L7               | 214.5  | N90°00'00"W |         |
| L8               | 142.6  | S0°00'00"E  |         |
| L9               | 73.8   | S33°40'56"W |         |

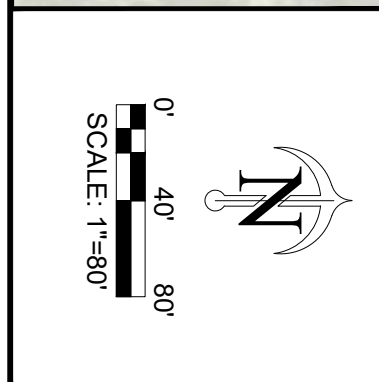

|                                               |                     |            |     |       |   |                              |
|-----------------------------------------------|---------------------|------------|-----|-------|---|------------------------------|
| NO<br>P1<br>P2<br>P3<br>P4<br>P5<br>REVISIONS | DESCRIPTION         | DATE       | BY  | CHK'D | 1 | RENG UAS TOPO - 2022-03-02   |
|                                               | FOR CLIENT REVIEW   | PENDING    | SSJ | NER   | 2 | WASHOE COUNTY OPEN DATA      |
|                                               | FOR CLIENT REVIEW   | 2022-03-22 | SSJ | -     | 3 | ORMAT LAYOUT - 2021-11-21    |
|                                               | FOR CLIENT REVIEW   | 2022-07-28 | SSJ | NER   | 4 | US BLM SURVEY #4323          |
|                                               | REVISED ACCESS ROAD | 2022-09-09 | SSJ | NER   | 5 | SOLARGIK - ARRAY LAYOUT REV1 |
|                                               | FOR CLIENT REVIEW   | 2022-10-25 | SSJ | NER   | 6 |                              |
|                                               |                     |            |     |       | 7 |                              |
|                                               |                     |            |     |       | 8 |                              |

**PRELIMINARY**  
**NOT FOR**  
**CONSTRUCTION**

848 VICTORIAN AVENUE  
SPARKS, NV 89435  
www.robisoneng.com  
(775) 852-2251

DRAWN: SSJ  
DATE: PENDING

PREPARED FOR:  
**ORMAT NV, INC.**

6140 PLUMAS ST, ST 200  
RENO, NV 89519  
(775) 356-9029

THE WET-STAMPED AND PERMITTED/RECORDED COPY OF THIS PLAN SUPERCEDES ALL OTHER VERSIONS, INCLUDING COPIES AND ELECTRONIC DATA. SEE PROJECT NOTES AND CONTRACT AGREEMENT.

0" 1/2" 1"  
INCH=FULL SCALE

**NORTH VALLEY SOLAR PLAN**  
**CIVIL PLANS**

SHEET C1.0  
SITE PLAN

WASHOE COUNTY  
PROJECT NO: 1-0184-31.007

NEVADA

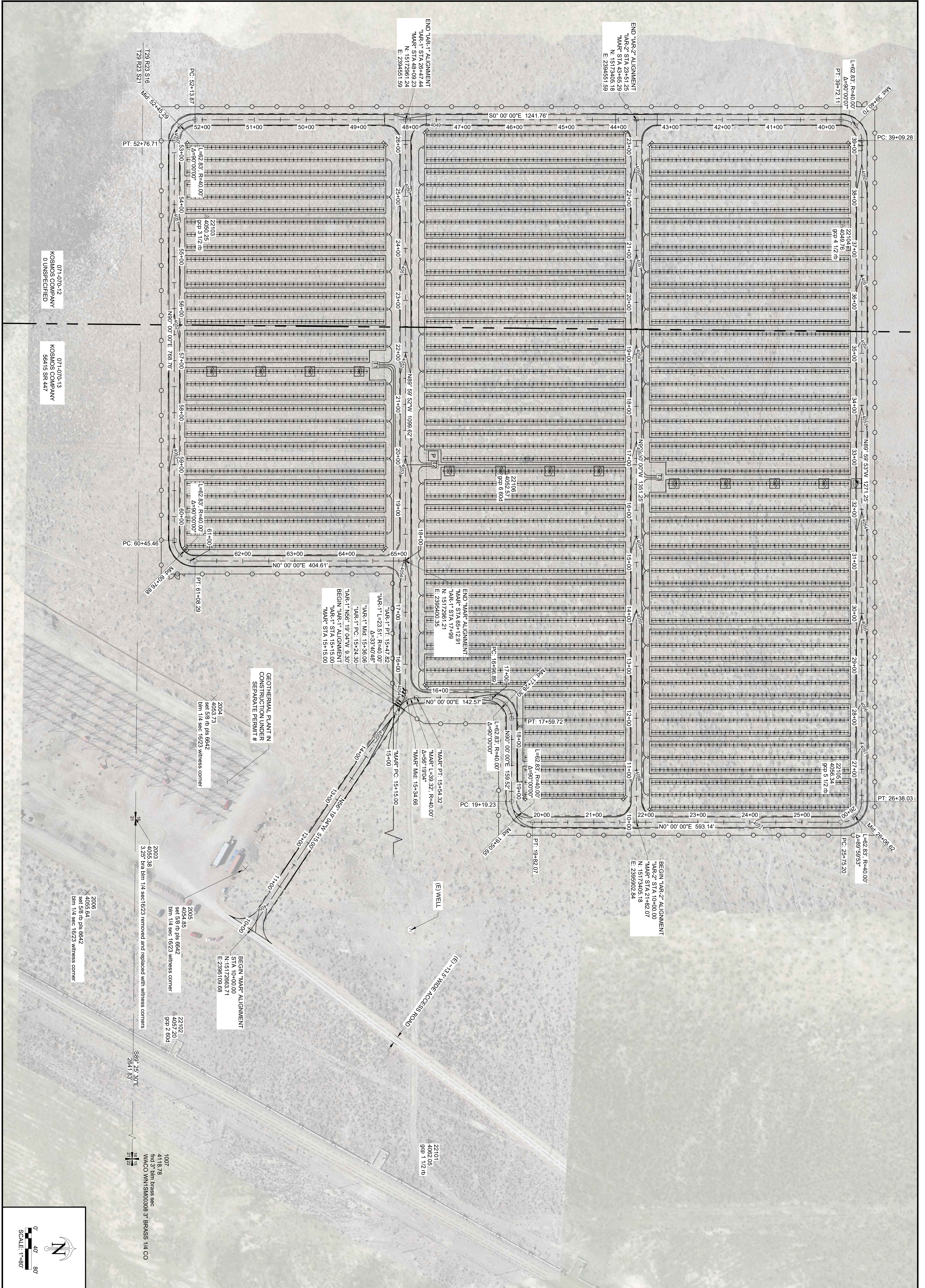

07-070-12  
KOSMOS COMPANY  
UNSPECIFIED

07-070-13  
KOSMOS COMPANY  
56415 SR 447

GEO-THERMAL PLANT IN  
CONSTRUCTION UNDER  
SEPARATE PERMIT #

2004  
4053.79  
set 5/8 to p/s 6642  
b/m 1/4 sec 16223 witness corner

2006  
4055.64  
set 5/8 to p/s 6642  
b/m 1/4 sec 16223 witness corner

2005  
4055.98  
3/25" bra b/m 1/4 sec 16223 removed and replaced with witness corners

BEGIN MAR ALIGNMENT  
STA 10+00.00  
N: 1517283.71  
E: 2396109.68

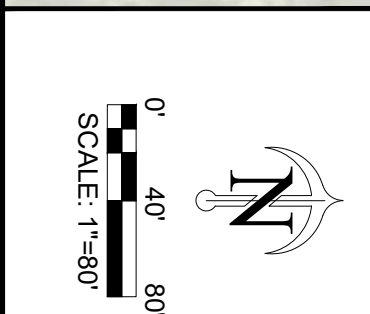

| NO | DESCRIPTION         | DATE       | BY  | CHK'D |
|----|---------------------|------------|-----|-------|
| P1 | FOR CLIENT REVIEW   | PENDING    | SSJ | NER   |
| P2 | FOR CLIENT REVIEW   | 2022-03-22 | SSJ | NER   |
| P3 | FOR CLIENT REVIEW   | 2022-07-28 | SSJ | NER   |
| P4 | REVISED ACCESS ROAD | 2022-09-09 | SSJ | NER   |
| P5 | FOR CLIENT REVIEW   | 2022-10-25 | SSJ | NER   |

**PRELIMINARY**  
**NOT FOR**  
**CONSTRUCTION**

**Robison Engineering**  
846 VICTORIAN AVENUE  
SPARKS, NV 89631  
www.robisoneng.com  
(775) 852-2251  
DRAWN: SSJ  
DATE: PENDING

PREPARED FOR:  
**ORMAT NV, INC.**  
6140 PLUMAS ST. ST 200  
RENO, NV 89519  
(775) 356-9029

THE WET STAMPED AND PERMITTED/RECORDED COPY OF THIS PLAN SUPERCEDES ALL OTHER VERSIONS, INCLUDING COPIES AND ELECTRONIC DATA. SEE PROJECT NOTES AND CONTRACT AGREEMENT.  
0" 1/2" 1"  
INCH=FULL SCALE

**NORTH VALLEY SOLAR PLAN**  
**CIVIL PLANS**  
SHEET C1.1  
HORIZONTAL CONTROL PLAN  
WASHOE COUNTY PROJECT NO: 1-0184-31.007 NEVADA

APPROVALS  
**C1.1**  
SHEET 5 OF 7

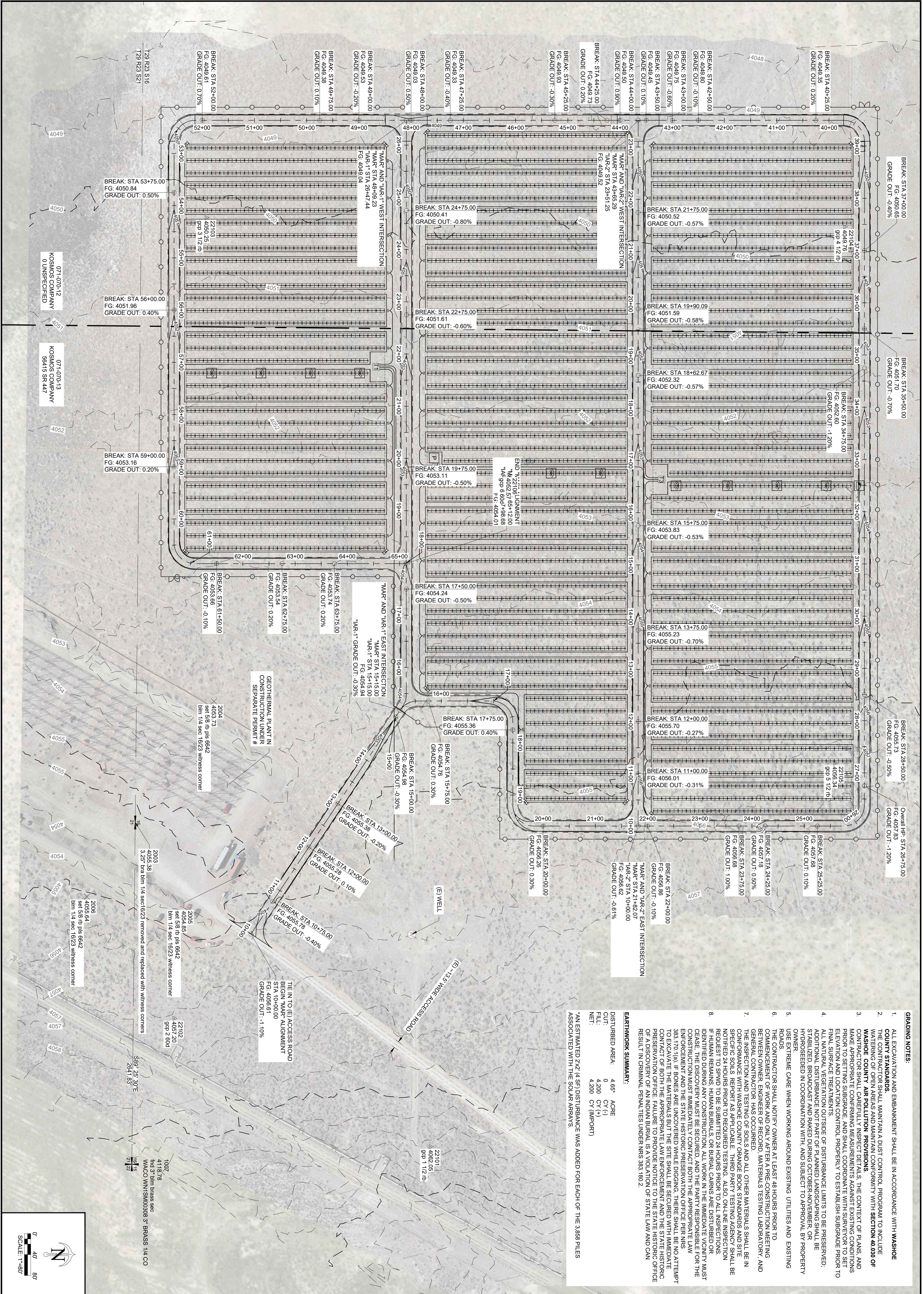

**GRADING NOTES:**

1. ALL EXCAVATION AND EMBANKMENT SHALL BE IN ACCORDANCE WITH WASHOE COUNTY STANDARDS.
2. THE CONTRACTOR SHALL MAINTAIN A DUST CONTROL PROGRAM TO INCLUDE WASHOE COUNTY AIR POLLUTION PROVISIONS WITH SECTION 40.030 OF WASHOE COUNTY AIR POLLUTION PROVISIONS.
3. CONTRACTOR SHALL CAREFULLY INSPECT DETAILS, THE CONTEXT OF PLANS, AND MAKE APPROPRIATE CORRECTING MEASUREMENTS AGAINST EXISTING CONDITIONS PRIOR TO SETTING SUBGRADE, AND SHALL COORDINATE WITH SURVEYOR TO SET ELEVATION AND LOCATION CONTROL POINTS TO ESTABLISH SUBGRADE PRIOR TO FINAL SURFACE TREATMENTS.
4. ALL NATURAL VEGETATION OUTSIDE OF DISTURBANCE LIMITS TO BE PRESERVED. ADDITIONAL DISTURBANCE NOT PART OF PLANNED OVERSOWING SHALL BE STABILIZED PROXIMOUS AND RAKED DURING OILSPILL-CLEANUP OR OTHER DISTURBANCE AND SUBJECT TO APPROVAL BY PROPERTY OWNER.
5. USE EXTREME CARE WHEN WORKING AROUND EXISTING UTILITIES AND EXISTING ROADS.
6. THE CONTRACTOR SHALL NOTIFY OWNER AT LEAST 48 HOURS PRIOR TO COMMENCEMENT OF WORK AND ONLY AFTER A PRE-CONSTRUCTION MEETING BETWEEN OWNER, ENGINEER OF RECORD, MATERIALS TESTING LABORATORY, AND GENERAL CONTRACTOR HAS OCCURRED.
7. THE INSPECTION AND TESTING OF SOILS AND ALL OTHER MATERIALS SHALL BE IN ACCORDANCE WITH WASHOE COUNTY ORANGE BOOK STANDARDS AND SHALL BE IN WRITING. THE CONTRACTOR SHALL NOTIFY OWNER AND ENGINEER OF RECORD 24 HOURS PRIOR TO REQUIRED TESTING. ALSO, ONLINE INSPECTION REQUEST TO SWPD TO BE SUBMITTED 24 HOURS PRIOR TO ALL INSPECTIONS. IF HUMAN REMAINS, HUMAN BURIALS, OR BURIAL CAINS ARE DISTURBED OR IDENTIFIED DURING ANY CONSTRUCTION, ALL WORK IN THE IMMEDIATE VICINITY MUST CEASE. THE DISCOVERY MUST BE SECURED, AND THE PARTY RESPONSIBLE FOR THE CONSTRUCTION MUST IMMEDIATELY CONTACT BOTH THE APPROPRIATE LAW ENFORCEMENT AND THE STATE HISTORIC PRESERVATION OFFICE PER NRS 363.700 (6) IF BONES ARE UNCOVERED WHILE DIGGING, THERE SHALL BE NO ATTEMPT TO EXCAVATE THE MATERIALS BUT THE SITE SHALL BE SECURED WITH IMMEDIATE CONTACT WITH THE HISTORIC PRESERVATION OFFICE. FAILURE TO PROVIDE NOTICE TO THE STATE HISTORIC PRESERVATION OFFICE OF A DISCOVERY OF AN INDIAN BURIAL IS A VIOLATION OF STATE LAW AND CAN RESULT IN CRIMINAL PENALTIES UNDER NRS 383.180.2

**EARTHWORK SUMMARY:**

|                 |                                      |
|-----------------|--------------------------------------|
| DISTURBED AREA: | 4.65' ACRE                           |
| CUT:            | 0 C.Y. (0)                           |
| FILL:           | 2,200 C.Y. (10,000 FT <sup>3</sup> ) |
| NET:            | 4,200 C.Y. (19,000 FT <sup>3</sup> ) |

\*AN ESTIMATED 2% (4 SF) DISTURBANCE WAS ADDED FOR EACH OF THE 3,858 PILES ASSOCIATED WITH THE SOLAR ARRAYS.

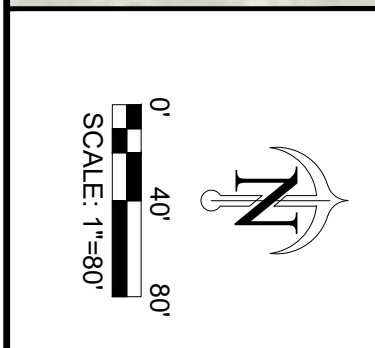

| NO | DESCRIPTION         | DATE       | BY  | CHK'D |
|----|---------------------|------------|-----|-------|
| P1 | FOR CLIENT REVIEW   | PENDING    | SSJ | NER   |
| P2 | FOR CLIENT REVIEW   | 2022-03-22 | SSJ | NER   |
| P3 | FOR CLIENT REVIEW   | 2022-07-28 | SSJ | NER   |
| P4 | REVISED ACCESS ROAD | 2022-09-09 | SSJ | NER   |
| P5 | FOR CLIENT REVIEW   | 2022-10-25 | SSJ | NER   |

| NO | DESCRIPTION                  | DATE | BY | CHK'D |
|----|------------------------------|------|----|-------|
| 1  | RENG UAS TOPO - 2022-03-02   |      |    |       |
| 2  | WASHOE COUNTY OPEN DATA      |      |    |       |
| 3  | ORMAT LAYOUT - 2021-11-21    |      |    |       |
| 4  | US BLM SURVEY #4323          |      |    |       |
| 5  | SOLARGIK - ARRAY LAYOUT REV1 |      |    |       |
| 6  |                              |      |    |       |
| 7  |                              |      |    |       |
| 8  |                              |      |    |       |

**PRELIMINARY  
NOT FOR  
CONSTRUCTION**

**Robison Engineering**  
 846 VICTORIAN AVENUE  
 SPARKS, NV 89435  
 www.robisoneng.com  
 (775) 852-2251  
 DRAWN: SSJ  
 DATE: PENDING

PREPARED FOR:  
**ORMAT NV, INC.**  
 6140 PLUMAS ST, ST 200  
 RENO, NV 89519  
 (775) 356-9029

THE WET-STAMPED AND PERMITTED/RECORDED COPY OF THIS PLAN SUPERCEDES ALL OTHER VERSIONS, INCLUDING COPIES AND ELECTRONIC DATA. SEE PROJECT NOTES AND CONTRACT AGREEMENT.

0" = 1/2" = 1"  
 INCH=FULL SCALE

**NORTH VALLEY SOLAR PLAN  
CIVIL PLANS**

SHEET C2.0  
 GRADING PLAN

WASHOE COUNTY  
 PROJECT NO: 1-0184-31.007

NEVADA

**CIVIL GENERAL SPECIFICATIONS:**

1. THE NATURAL GROUND SURFACE SHALL BE CLEARED OF ALL ORGANIC GROWTH, SUCH AS SOIL, TREES, LOGS, UPRIGHTED STUMPS, ROOTS OF DOWNED TREES, BRUSH, GRASS, WEEDS, AND ALL OTHER DEBRIS.
  2. GRUBBING SHALL EXTEND TO THE OUTSIDE EXCAVATION AND FINISH SLOPE LINES, EXCEPT THAT WHERE SLOPES ARE TO BE ROUNDED, THE AREAS SHALL EXTEND TO THE OUTSIDE LIMITS OF SLOPE ROUNDED WITHIN THE LIMITS OF CLEARING. ALL STUMPS, ROOTS 1/2 INCH IN DIAMETER OR LARGER, BURIED LOGS, AND ALL OTHER OBJECTIONABLE MATERIAL SHALL BE REMOVED, 1 FOOT BELOW THE EXISTING GROUND SURFACE OR SUBGRADE, WHICHEVER IS DEEPER. RESULTING EXCAVATIONS SHALL BE BACKFILLED WITH STRUCTURAL FILL COMPACTED TO 90 PERCENT RELATIVE COMPACTION.
- SUBGRADE:**
1. AFTER ROUGH GRADING HAS BEEN COMPLETED WHEN SCARIFYING AND CULTIVATING ARE REQUIRED, THE SUBGRADE SHALL BE LOOSENESED TO A DEPTH OF AT LEAST 6 INCHES. THE LOOSENESED MATERIAL SHALL THEN BE WORKED TO A FINELY DIVIDED CONDITION AND ALL ROCKS LARGER THAN 4 INCHES IN DIAMETER SHALL BE REMOVED. THE MOISTURE CONTENT SHALL BE BROUGHT WITHIN +/- 3% OPTIMUM IN ORDER TO ALLOW DENSIFICATION TO THE SPECIFIED MINIMUM RELATIVE COMPACTION.
  2. UNDER PERIODS SOLE THAT ALLOW THE PENETRATION OF WATER, OR UNDER IMPERVIOUS SOILS WHICH WILL ALLOW THE PENETRATION OF WATER TO A DEPTH OF AT LEAST 6 INCHES, THE SUBGRADE SHALL BE TREATED WITH AN APPROPRIATE WATER-REPELLENT. WHEN SCARIFYING AND CULTIVATING ARE NOT REQUIRED, THE MOISTURE CONTENT OF THE TOP 6 INCHES OF THE SUBGRADE MATERIAL SHALL BE BROUGHT TO SUFFICIENTLY NEAR OPTIMUM BY MOISTURE CONDITIONING TO ALLOW DENSIFICATION TO THE SPECIFIED MINIMUM RELATIVE COMPACTION.
  3. UNLESS SPECIFIED OTHERWISE, ALL SUBGRADE SHALL BE DESIGNED TO A RELATIVE COMPACTION OF NOT LESS THAN 90 PERCENT FOR A MINIMUM DEPTH OF 6 INCHES. IN ACCORDANCE WITH TEST PROCEDURES SET FORTH IN ASTM D 1557, SUBGRADE BENEATH FULL DEPTH ASPHALT PAVEMENTS SHALL BE DENSIFIED FOR A DEPTH OF AT LEAST 6 INCHES TO A MINIMUM 95 PERCENT RELATIVE COMPACTION.
  4. NATIVE SUBGRADE OR IMPORTED SUBBASE SHALL NOT VARY MORE THAN 0.1 FOOT FROM THE SPECIFIED GRADE AND CROSS SECTION. VARIATIONS WITHIN THE ABOVE SPECIFIED TOLERANCES SHALL BE COMPENSATING SO THAT THE AVERAGE GRADE AND CROSS SECTION SPECIFIED ARE MET.
  5. IF CLAYEY OR OTHERWISE UNSUITABLE SOILS ARE PRESENT ON SITE, SOILS SHALL BE PLACED ONLY IN NONSTRUCTURAL AREAS SUCH AS SLOPES, WHERE CLAY SOILS ARE EXPOSED AT PAD OR FOUNDATION GRADE, SOILS SHALL BE OVEREXCAVATED AND REPLACED WITH AT LEAST 2 FEET OF STRUCTURAL FILL. THE LIMITS OF OVEREXCAVATION SHALL EXTEND A MINIMUM OF 3 FEET BEYOND THE PERIMETER OF ALL STRUCTURES ON SITE.
- AGGREGATE BASE COURSES:**
1. THE APPROVED MATERIAL SHALL BE PLACED UNIFORMLY ON THE APPROVED SUBGRADE BY MEANS OF A HAULING VEHICLE WITH OR WITHOUT SPREADING DEVICES.
  2. SPREADING SHALL BE DONE IN SUCH A MANNER AS TO PREVENT SEGREGATION OF THE DIFFERENT SIZES OF MATERIAL, AND ANY SUCH SEGREGATION, UNLESS SATISFACTORILY CORRECTED, SHALL BE CAUSE FOR REJECTION AT THE DISCRETION OF THE ENGINEER.
  3. WHERE THE REQUIRED THICKNESS IS 6 INCHES OR LESS, THE BASE MATERIALS MAY BE SPREAD IN ONE LAYER, WHERE THE REQUIRED THICKNESS IS MORE THAN 6 INCHES, THE BASE MATERIAL SHALL BE SPREAD FOR REQUIRED THICKNESS IN EACH LAYER NOT TO EXCEED 6 INCHES. WHEN LARGE COMPACTION EQUIPMENT IS UTILIZED, BASE MATERIALS CAN BE SPREAD FOR COMPACTION IN > 6 INCH LIFTS IF IT CAN BE DEMONSTRATED THAT ADEQUATE COMPACTION CAN BE ATTAINED.
  4. THE APPROVED MATERIALS SHALL BE SPREAD AT OPTIMUM MOISTURE CONTENT AS DETERMINED BY PROCEDURES SET FORTH IN ASTM 1557. THE SURFACE OF ANY LAYER SHALL BE MAINTAINED IN SUCH A MANNER AS TO PREVENT THE SUCCEEDING LAYER(S) PLACED THEREON FROM BEING PROPERLY DRAINED AT ALL TIMES. ANY LOSS OF DENSITY IN THE UPPER PORTIONS OF THE MATERIAL, DUE TO THE ELEMENTS, OR BECAUSE OF A LAPSE OF TIME, OR FOR OTHER REASONS, SHALL REQUIRE RECOMPACTION TO THE SPECIFIED DENSITY PRIOR TO PLACEMENT OF ANY SUBSEQUENT COURSE, WITH NO ADDITIONAL COMPENSATION FOR SUCH RECOMPACTION.
  5. WAVES, CORRUGATIONS, AND BUTS WILL NOT BE ALLOWED TO FORM AND THE BASE SHALL BE BLENDED AS OFTEN AS NECESSARY, REWATERED, AND RECOMPACTION TO MAINTAIN A TRUE CROSS SECTION. WHEN A 12 FOOT STRAIGHT EDGE IS LAID IN ANY DIRECTION, THE FINISHED SURFACE SHALL NOT DEVIATE AT ANY POINT MORE THAN 0.05 FOOT FROM THE BOTTOM OF THE STRAIGHTEDGE OR FROM PLAN GRADE.

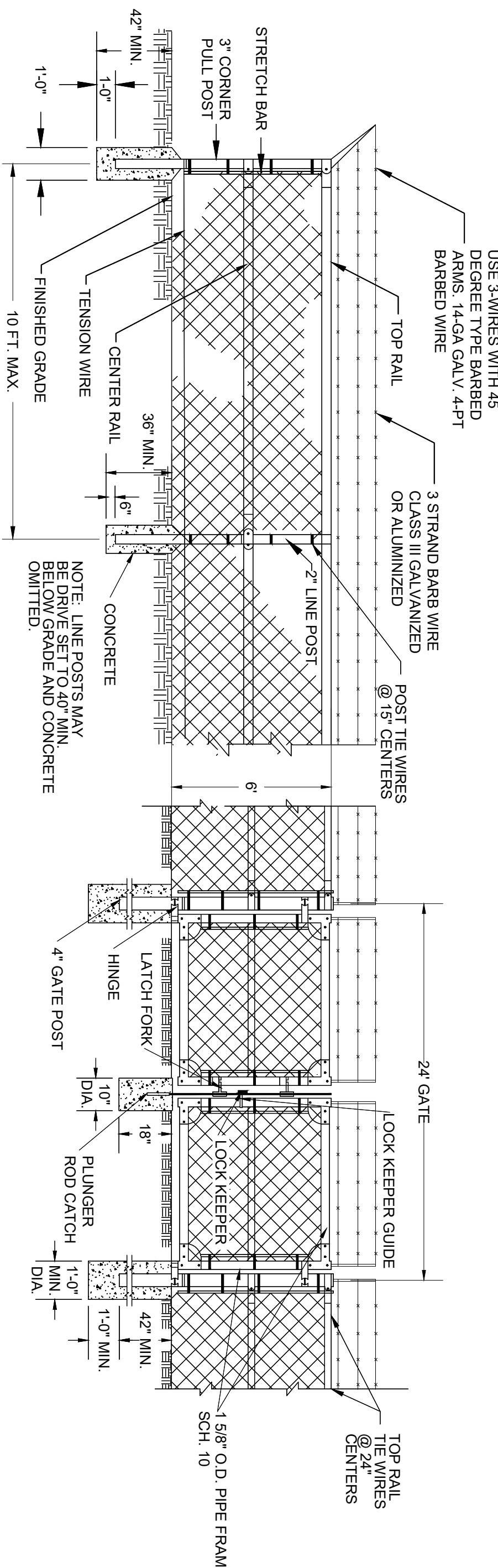

**1 PLANT PERIMETER CHAIN LINK FENCE**  
SCALE: NTS

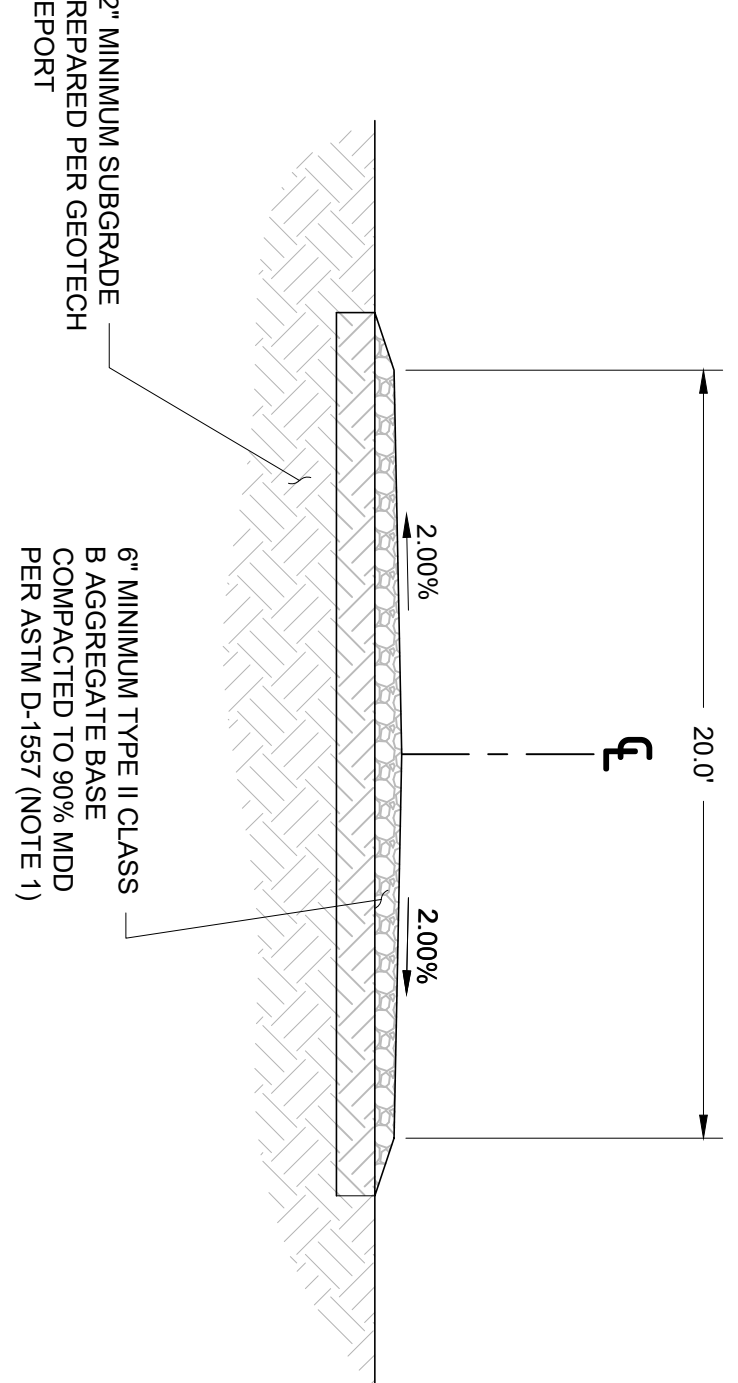

**2 PLANT ROAD SECTION**  
SCALE: NTS

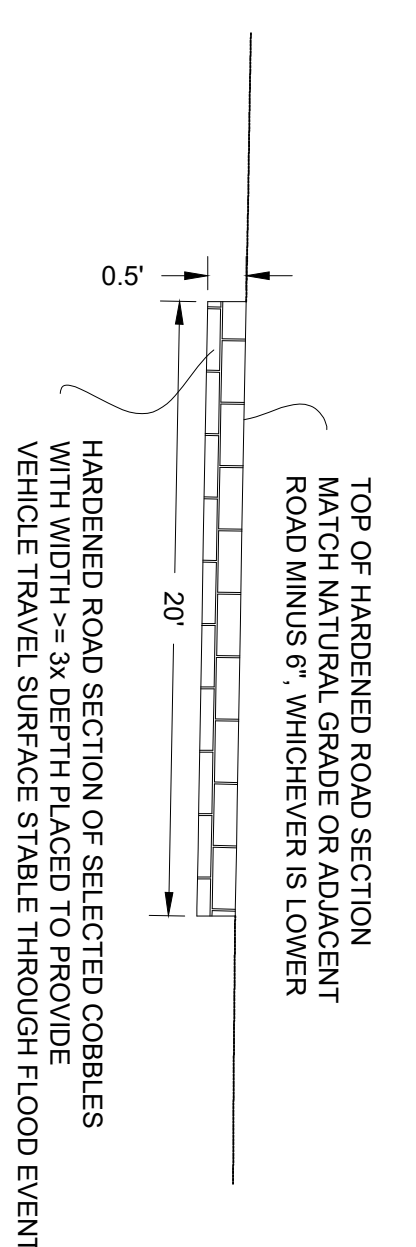

**3 HARDENED ROAD SECTION**  
SCALE: NTS

- FENCING:**
1. IN ADDITION TO CLEARING AND GRUBBING, THE CONTRACTOR SHALL PERFORM GRADING NECESSARY TO PERMIT PLACEMENT OF THE FENCE, FENCE GATES, AND OTHER APPURTENANCES. IN COMPLIANCE WITH THE PLANS, THE STANDARD DETAILS, AND THESE SPECIFICATIONS, THE PREPARED SURFACE SHALL BE ADEQUATELY COMPACTED, AS NECESSARY, TO RESULT IN A STABLE SURFACE FOR PLACEMENT OF FENCING.
  2. UNLESS OTHERWISE DIRECTED, THE CONTRACTOR SHALL DISTRIBUTE EXCESS SITE PREPARATION SOIL EVENLY ALONG THE FENCE.
  3. THE CLEARANCE BETWEEN THE BOTTOM WIRE/FABRIC ELEMENT AND THE GROUND SHOULD NOT EXCEED 4 INCHES IN ANY CASE WITH AN AVERAGE OR NOMINAL CLEARANCE OF 2 INCHES. CLEARANCE SHOULD BE EVALUATED PRIOR TO SETTING OF ANY POSTS.
- INSPECTION AND TESTING:**
1. ALL MATERIALS FURNISHED BY THE CONTRACTOR SHALL BE SUBJECT TO THE INSPECTION, TESTING, AND APPROVAL BY THE ENGINEER.
  2. ALL SAMPLING AND TESTING SHALL BE PERFORMED BY AN APPROVED INDEPENDENT TESTING LABORATORY ACCREDITED BY AASHTO OR OTHER ASTM RECOGNIZED ACCREDITING ORGANIZATION IN THE APPLICABLE TEST METHODS.
- REFERENCE & END NOTES:**
1. STANDARD SPECIFICATIONS FOR PUBLIC WORKS CONSTRUCTION (WASHOE COUNTY RTC ORANGE BOOK) CURRENT REVISION.
  2. THE INTENT OF THE PLANS AND SPECIFICATIONS IS TO PRESCRIBE A COMPLETE OUTLINE OF WORK WHICH THE CONTRACTOR UNDERTAKES TO DO IN FULL COMPLIANCE WITH THE CONTRACT.
  3. UNLESS OTHERWISE PROVIDED IN THE PROPOSAL OR DETAIL SPECIFICATION, PLANS, PROFILES, AND INFORMATION AS THE ENGINEER MAY CONSIDER NECESSARY FOR THE CONTRACTOR'S GUIDANCE.
  4. IT SHALL BE DUTY OF THE CONTRACTOR TO SEE THAT THE PROVISIONS OF THESE SPECIFICATIONS ARE COMPLIED WITH IN DETAIL, IRRESPECTIVE OF THE INSPECTION GIVEN THE WORK DURING ITS PROGRESS BY THE AUTHORIZED OFFICIAL OR DESIGNATED REPRESENTATIVES.
  5. CONTRACTORS SHALL BE RESPONSIBLE FOR OBTAINING ALL NECESSARY PERMITS AND APPROVALS PRIOR TO THE COMMENCEMENT OF WORK. THE CONTRACTOR SHALL BE RESPONSIBLE FOR OBTAINING ALL NECESSARY PERMITS AND APPROVALS PRIOR TO THE COMMENCEMENT OF WORK. THE CONTRACTOR SHALL BE RESPONSIBLE FOR OBTAINING ALL NECESSARY PERMITS AND APPROVALS PRIOR TO THE COMMENCEMENT OF WORK. THE CONTRACTOR SHALL BE RESPONSIBLE FOR OBTAINING ALL NECESSARY PERMITS AND APPROVALS PRIOR TO THE COMMENCEMENT OF WORK.

| NO | DESCRIPTION         | DATE       | BY  | CHK'D |
|----|---------------------|------------|-----|-------|
| P1 | FOR CLIENT REVIEW   | PENDING    | SSJ | NER   |
| P2 | FOR CLIENT REVIEW   | 2022-03-22 | SSJ | NER   |
| P3 | FOR CLIENT REVIEW   | 2022-07-28 | SSJ | NER   |
| P4 | REVISED ACCESS ROAD | 2022-09-09 | SSJ | NER   |
| P5 | FOR CLIENT REVIEW   | 2022-10-25 | SSJ | NER   |

| NO | DESCRIPTION                  |
|----|------------------------------|
| 1  | RENG UAS TOPO - 2022-03-02   |
| 2  | WASHOE COUNTY OPEN DATA      |
| 3  | ORMAT LAYOUT - 2021-11-21    |
| 4  | US BLM SURVEY #4323          |
| 5  | SOLARGIK - ARRAY LAYOUT REV1 |
| 6  |                              |
| 7  |                              |
| 8  |                              |

**PRELIMINARY  
NOT FOR  
CONSTRUCTION**

**Robison Engineering**  
846 VICTORIAN AVENUE  
SPARKS, NV 89431  
www.robisoneng.com  
(775) 852-2251

DRAWN: SSJ  
DATE: PENDING

PREPARED FOR:  
**ORMAT NV, INC.**  
6140 PLUMAS ST, ST 200  
RENO, NV 89519  
(775) 356-9029

THE WET STAMPED AND PERMITTED/RECORDED COPY OF THIS PLAN SUPERSEDES ALL OTHER VERSIONS, INCLUDING COPIES AND ELECTRONIC DATA AND CONTRACT AGREEMENT.

0" 1/2" 1"  
INCH=FULL SCALE

**NORTH VALLEY SOLAR PLAN  
CIVIL PLANS**

SHEET C3.0  
CIVIL DETAILS AND SPECIFICATIONS

WASHOE COUNTY NEVADA  
PROJECT NO: 1-0184-31-007

APPROVALS

**C3.0**

SHEET 7 OF 7



| REV. | DESCRIPTION | DATE | APPROVED BY |
|------|-------------|------|-------------|
|------|-------------|------|-------------|

| ITEM NO. | PART NO          | DESCRIPTION                                 | QTY |
|----------|------------------|---------------------------------------------|-----|
| 1        | TT24.A 13        | Tracker Body 90 -24 -L5 -7P                 | 1   |
| 2        | PSB-A03          | Panel Support Beam ASM L5-AO3               | 24  |
| 3        | GUM-A02a03a07.00 | Ground Utility mounting -A02                | 7   |
| 4        | MUS-A04a04a02.00 | Tracker Motion Unit 120 -SELF CONTROL - A04 | 1   |

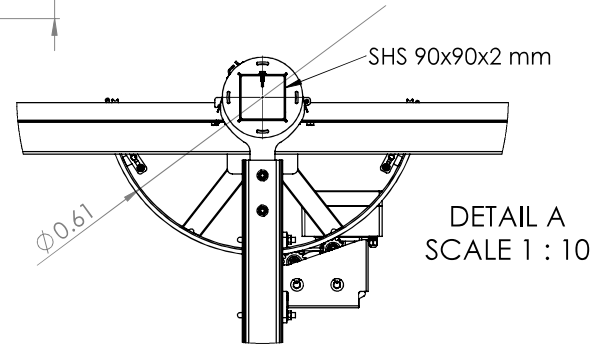
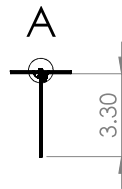
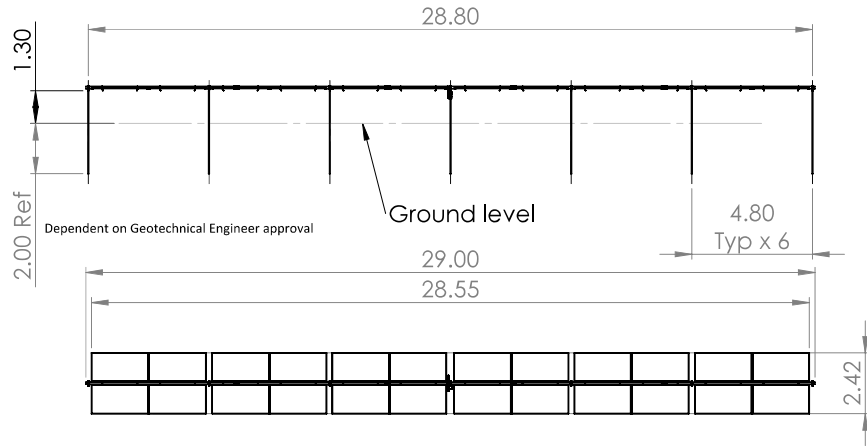

DETAIL A  
SCALE 1 : 10

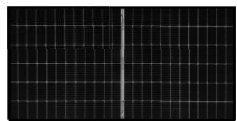

PV Panel:  
Longi - LR5-72HBD 525-545M  
2256 X 1133 X 35 mm  
32.3 kg  
24 units

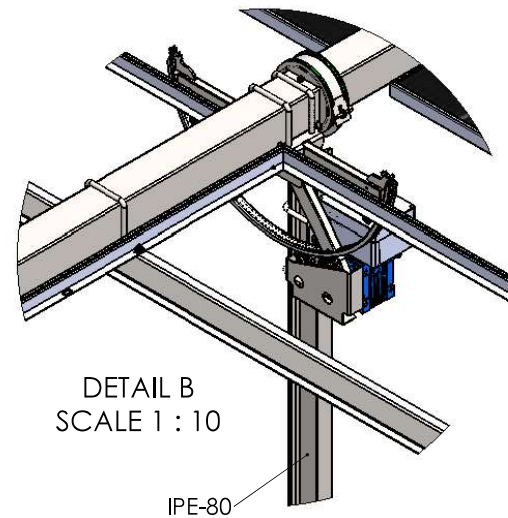
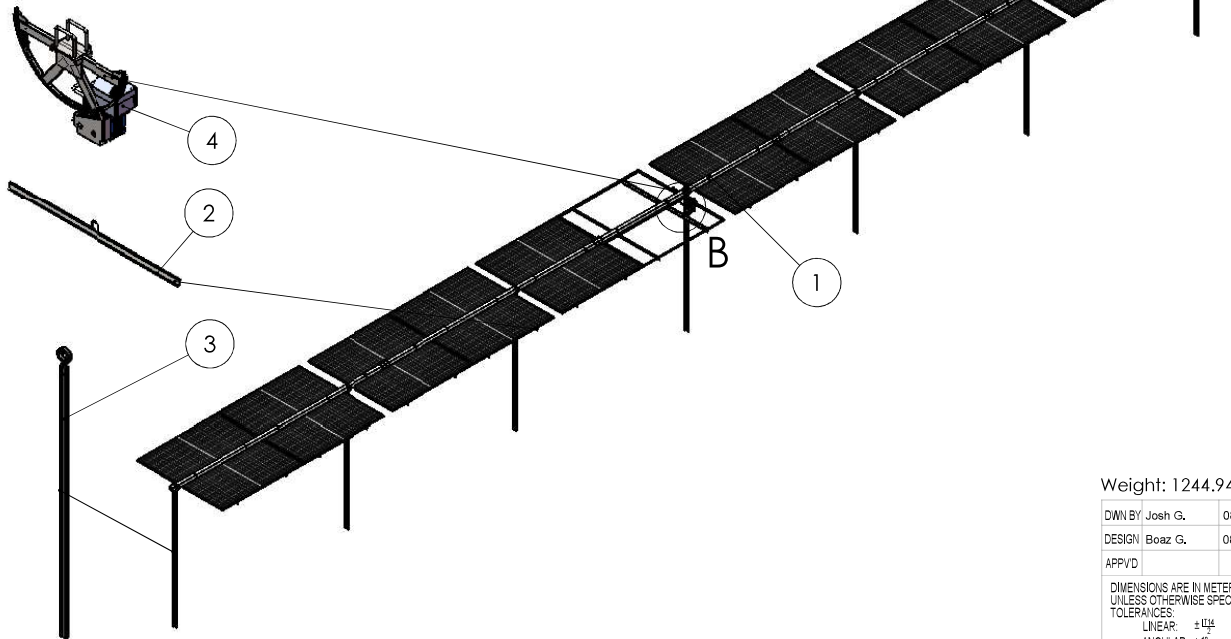

DETAIL B  
SCALE 1 : 10

Weight: 1244.94 [Kg]

DWN BY: Josh G. 08/06/2022  
DESIGN: Boaz G. 08/06/2022  
APPV'D:

DIMENSIONS ARE IN METERS  
UNLESS OTHERWISE SPECIFIED:  
TOLERANCES:  
LINEAR: ±0.15  
ANGULAR: ±1°  
HOLE: ±0.15  
CORNER AND EDGS RADIUS: 0.1-0.2  
DEBUR AND BREAK SHARP EDGES

Description:  
Ground Utility Tracker 24 -120 -L5 -7P -A03  
Part / Dwg. No.:  
GU-A03a13a02a04

**SolarGik**  
SolarGik LTD.  
Emek Refaim 48, Jerusalem  
9314205 Israel

Title:  
471-02-0001-A01, SGT-24, SGONV010, Main  
ASM  
REVISION:  
**A01**

THIS DRAWING SHOULD BE USED TOGETHER WITH 3D SOLID FILE. IN CASE OF MISSING DIMENSION, IT SHOULD BE TAKEN OUT OF THE 3D SOLID FILE  
SHEET 1 OF 1 | SCALE 1:200 | DO NOT SCALE DRAWING | A3

## Oakley, Katherine

---

**From:** Stacie Huggins <shuggins@WoodRodgers.com>  
**Sent:** Thursday, December 8, 2022 8:38 AM  
**To:** Oakley, Katherine  
**Subject:** North Valley Solar - setback

[NOTICE: This message originated outside of Washoe County -- **DO NOT CLICK** on links or open **attachments** unless you are sure the content is safe.]

Hello Kat – after reviewing and discussing with Ormat, redesigning the project to keep the panels on one parcel is not feasible. As an alternative, we would like to request to vary the setback along the shared property line to allow a minimum of 10 feet on either side of the shared property line. As we have discussed, the location, and orientation, of the panels across the two parcels was intentional so they would be close to the geothermal plant. If the panel orientation had been more confined in a north/south direction, it is likely there would have been increased earthwork associated with the project. Also, I know it's not labeled on the plans, but it may be helpful to know that the distance between the panel rows is 24 feet so there should be room to meet the 10' setback on either side of the shared property line.

Please let me know if you need anything else to support this request to vary the setback.

Thanks!

**Stacie Huggins** | Senior Planner

**Wood Rodgers, Inc.** | [www.woodrogers.com](http://www.woodrogers.com) |

775.823.4068 Main

775.823.5258 Direct

775.250.8213 Mobile

775.823.4066 Fax

[shuggins@WoodRodgers.com](mailto:shuggins@WoodRodgers.com)

**Follow Us** @WoodRodgersInc

| Please note that our offices will be closed from 12/26/2022 to 1/03/2023. Enjoy the holidays! |