

PLEASANT VALLEY ESTATES TENTATIVE SUBDIVISION MAP APPLICATION

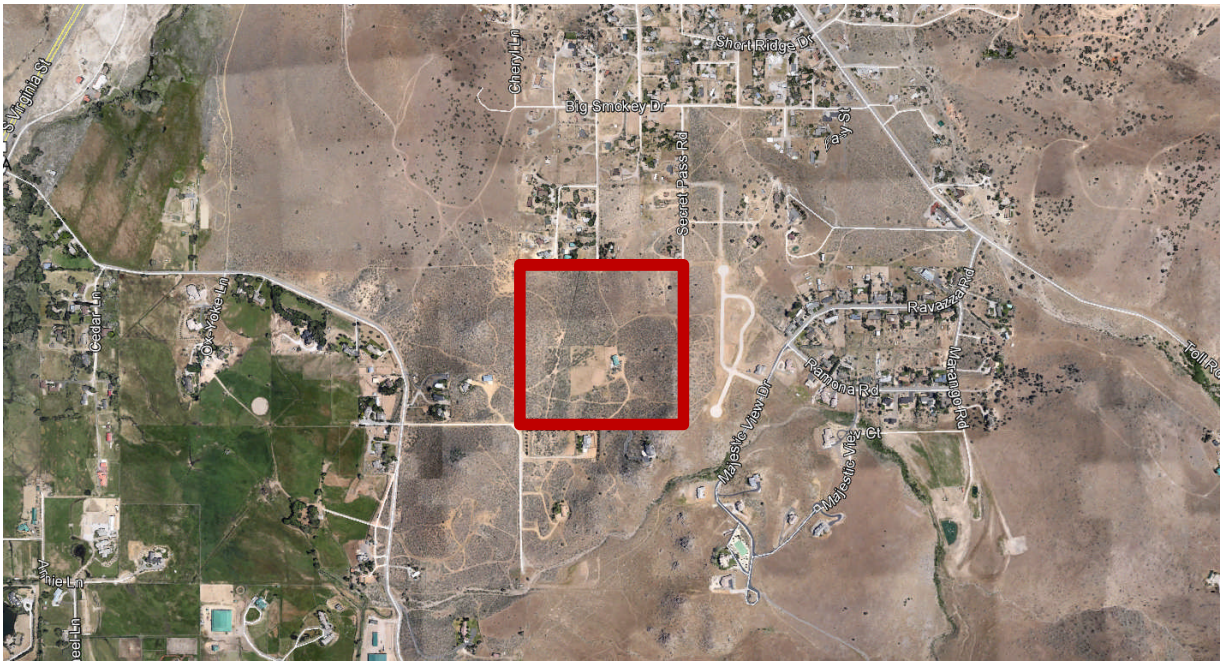

Prepared by:



November 15, 2016

PLEASANT VALLEY ESTATES TENTATIVE SUBDIVISION MAP

Prepared for:

Harry Fry
761 Greenbrae Drive
Sparks, NV 89431

Prepared by:

Rubicon Design Group, LLC
100 California Avenue, Suite 202
Reno, NV 89509
(775) 425-4800

November 15, 2016

Table of Contents

Introduction	3
Project Location	3
Project Summary.....	6
Site Analysis	8
Common Open Space	8
Hillside	12
Potential Impacts	14
Planning Policy Analysis	15
Tentative Map Findings	17

List of Figures:

Figure 1 – Vicinity Maps.....	3
Figure 2 – Existing Conditions	4
Figure 3 – Existing Cultural/Historical Resource.....	6
Figure 4 – Proposed Subdivision Map	7
Figure 5 – Slope Analysis.....	10

Appendices:

Washoe County Development Application	
Tentative Subdivision Map Supplemental Information	
Owner Affidavit	
Proof of Property Tax Payment	
Title Report	
Reduced Exhibits	
Request to Reserve New Street Names	
Application for Will-Serve Letter	
Technical Reports	
• Geotechnical Report	
• Sewer Study	
• Drainage/Hydrology Report	
Full-size Exhibits	
Survey Computations	

Introduction

This application includes the following request:

- A **Tentative Subdivision Map with Common Open Space** to create 54 single-family lots on approximately 39.34 acres within the South Valleys Area Plan.

Project Location

The Pleasant Valley Estates site (APNs 017-410-38 and 017-410-39) consists of approximately 39.34 acres and is located north of Chance Lane, east of Rhodes Road, south of Big Smokey Drive, and west of Toll Road.



Figure 1 – Vicinity Map

The proposed property consists of several different zoning designations, including MDS (Medium Density Suburban), LDS (Low Density Suburban), MDR (Medium Density Rural), and GR (General Rural). The property is currently vacant except for one single-family residential unit in the center of the site. Adjacent zoning designations consist of MDS to the north, a combination of MDS and LDS to the west, a combination of MDR and HDR (High Density Residential) to the south, and LDS to the east.

Figure 2 (below) depicts the existing site conditions.

PLEASANT VALLEY ESTATES



Looking North Across Site



Looking East Across Site

PLEASANT VALLEY ESTATES



Looking South Across Site



Looking West Across Site

Figure 2 – Existing Conditions

Project Summary

As noted previously, this application includes a tentative Subdivision Map request to create 54 single-family lots at the project site. It is planned to develop Pleasant Valley Estates utilizing a Common Open Space Development approach, per the standards contained in Article 408 of the Washoe County Development Code.

The plan developed for Pleasant Valley Estates includes 54 lots for an overall density of 1.37 units per acre. Included within the project are 5.35 acres of open space. This includes a 5.14-acre open space area on the east side that will provide passive and active recreational opportunities for residents. It is envisioned that this area will serve much like a neighborhood park and can accommodate a wide range of recreational uses. The park area was located based the existence of a fairly substantial hillside that runs on the eastern side of the subject property. It is also noteworthy that no motorized vehicles will be allowed in this area. In addition, a .21-acre open space lot has been provided near the western property line to protect a large boulder with historical markings on it, shown in Figure 3 (below).

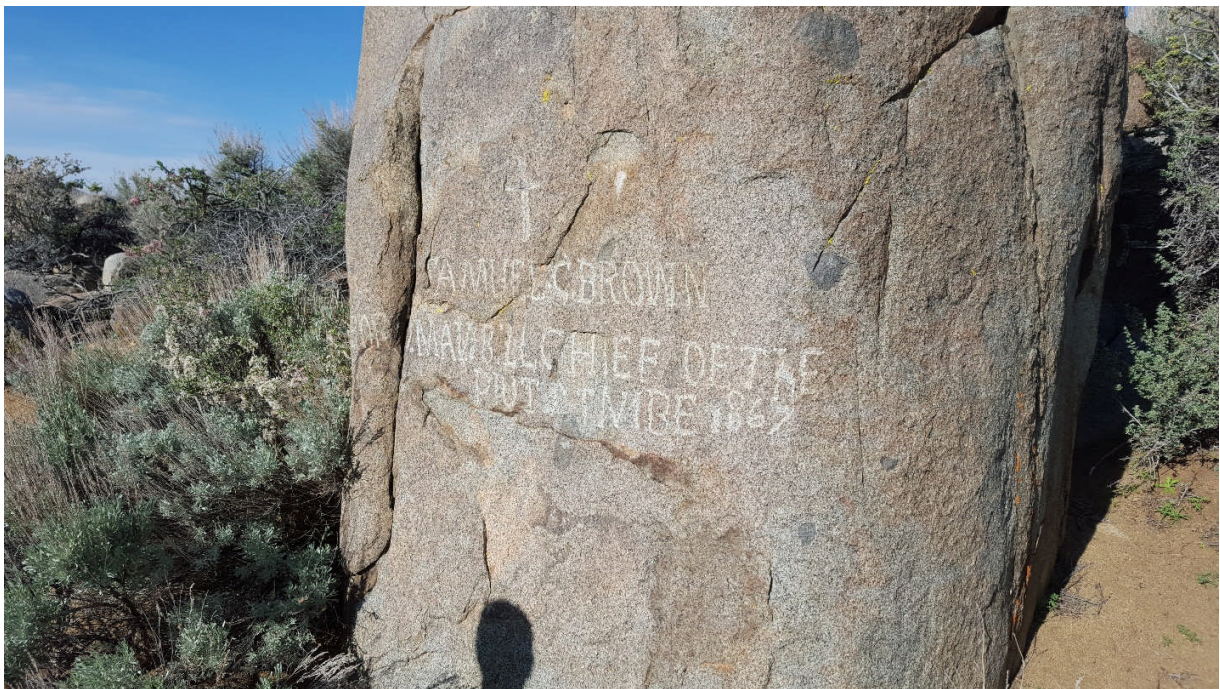

Figure 3 – Existing Historical/Cultural Resource

Although the open space areas within Pleasant Valley Estates will be private and maintained by a planned LMA (Landscape Maintenance Association), a public use easement will be dedicated to allow all residents access.

PLEASANT VALLEY ESTATES

Lot sizes within Pleasant Valley Estates are consistent with the MDS zoning and are complementary to the existing subdivision to the north. Lots within Pleasant Valley Estates range in size from 12,508 square feet to 1.65 acres with an overall average lot size of 22,577± square feet.

Figure 4 (below) depicts the overall layout proposed for Pleasant Valley Estates.

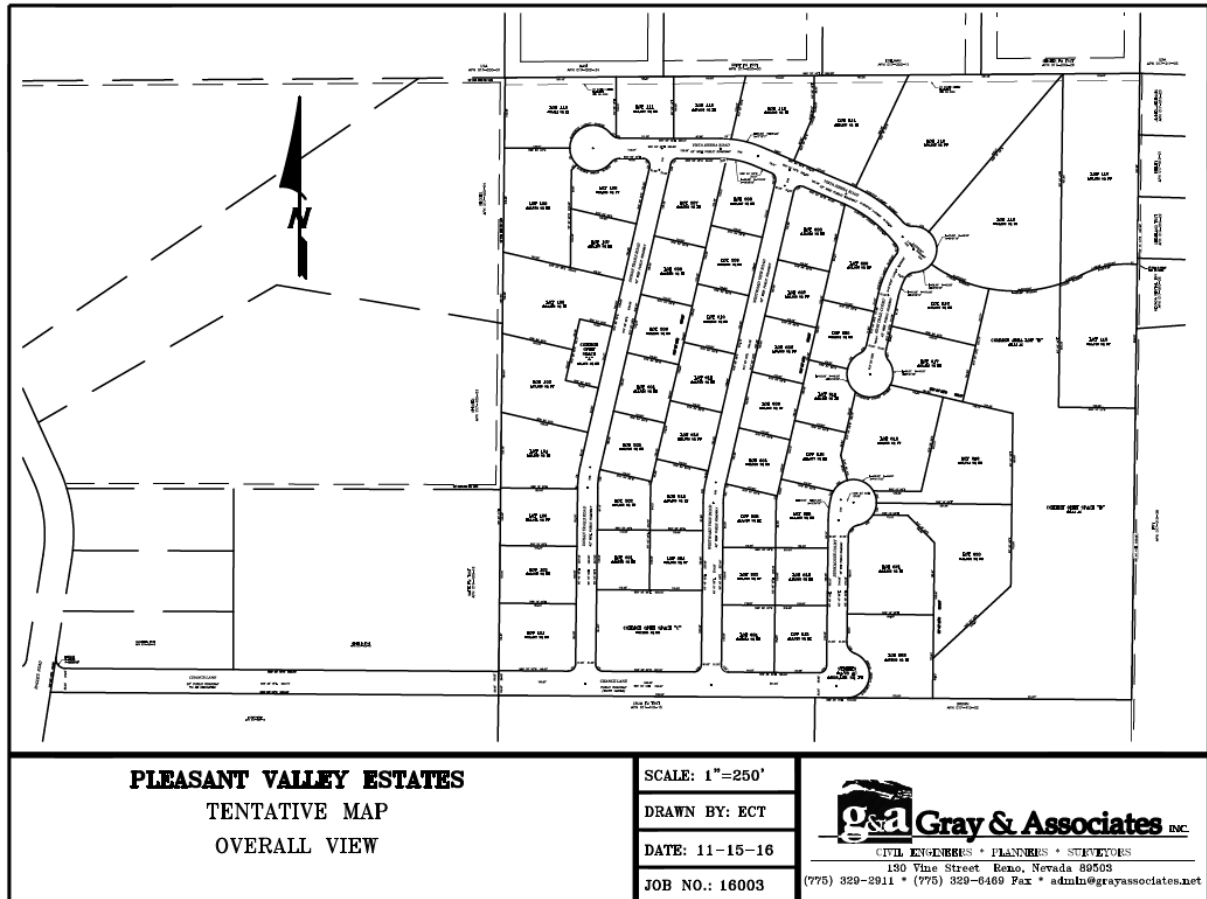

Figure 4 – Proposed Subdivision Map

Primary access will be provided from Chance Lane with a secondary access connecting to Rocky Vista Road to the north. This will ensure proper emergency access and meets all applicable Washoe County requirements. As a relatively small single-family development, the AM and PM peak trips are below the threshold for requiring a traffic study. To accommodate the small amount of increased traffic, existing roads around the site will be improved to Washoe County standards. Roadways within Pleasant Valley Estates will also be constructed to Washoe County standards and will be dedicated as public rights-of-

way. Roads will include 42-foot right of way with curb, gutter, and sidewalk.

Phasing for the project will largely be dependent on current market conditions. It is envisioned that there will be no more than 5 phases for the project. Final maps may be recorded separately or concurrently for each phase and bonding for improvements shall occur in accordance with Washoe County requirements and policies.

Home plans for Pleasant Valley Estates are still being developed and are envisioned to complement surrounding development. Larger lots included within Pleasant Valley Estates are conducive to larger single story floor plans although no limitation on two-story models is proposed. Consistent with Washoe County policy, final home plans and elevations will be subject to the review and approval of the Washoe County Design Review Committee for compliance with development code and Area Plan standards.

Fencing for the project will include six-foot wood fences for side and rear yards. Lots adjoining open space areas will include a 4-foot open fence such as split rail or wrought iron.

Site Analysis

Common Open Space:

Article 408 of the Washoe County Development Code establishes regulations related to Common Open Space Developments (COSD). Specifically, Section 110.408.30 requires a site analysis be conducted. This site analysis criteria is listed below and addressed in **bold face** type.

Section 110.408.30 Site Analysis to Determine Common Open Space and Lot Size Variations. A site analysis showing development opportunities and constraints shall be prepared as a key consideration, along with the project design objectives, to determine the total area covered by lots and roads, lot areas, and the total area to be designated as common open space. The site analysis shall include information and maps, including a site opportunities and constraints map, describing all significant physical and contextual features or factors which may affect the development of the property. The elements of the site analysis shall include, as a minimum, the following information:

(a) Location Map. A general location map providing the context of location and vicinity of the site.

Figure 1 included in this report provides an overall location/vicinity map for Pleasant Valley Estates. Additionally, a vicinity map is also included on the Tentative Map Title Sheet in the attached map pocket.

(b) Land Use. Current and planned land use on the site and adjacent current, planned and approved, but unbuilt land uses.

As depicted in Figures 1 and 2 of this report, the project site is currently vacant except for one single-

PLEASANT VALLEY ESTATES

family residence. Surrounding parcels consist of scattered single-family residences or vacant lots as shown in Figure 1. The surrounding lots are complementary to the proposed lot sizes within Pleasant Valley Estates.

- (c) Existing Structures. A description of the location, physical characteristics, condition and proposed use of any existing structures.

The existing single-family residence is located near the center of the two properties included in this proposal. The residence is in fairly good condition and will continue to function as a single-family residence. The proposed tentative map has created a separate lot for this residence.

- (d) Existing Vegetation. A description of existing vegetation, including limits of coverage, and major tree sizes and types. In the instance of heavily wooded sites, typical tree sizes, types and limits of tree coverage may be substituted.

The Pleasant Valley Estates site is characterized by natural vegetation consisting mostly of sagebrush, rabbit brush, and patches of cheat grass. There are no existing trees on the property no are there any known foreign species, etc.

- (e) Prevailing Winds. An analysis of prevailing winds.

Prevailing winds in the area are from west to east with occasional northerly winds during storm events. The proposed project layout should not be negatively impacted by the prevailing winds in the area.

- (f) Topography. An analysis of slopes on the site using contour interval of five (5) feet, or at a contour interval appropriate for the site and agreed to by the Director of Community Development.

The project site qualifies as a hillside development and contains slopes greater than 30 percent on approximately 4.5 percent of the site. A slope analysis has been performed by the project engineer (see Figure 5 below) showing the amount of the subject parcels that contain slopes. The engineering plans included with this application provide for grading and drainage plans that clearly depict the site topography. The portion of hillside area that cannot reasonably be graded will be included in the common open space area.

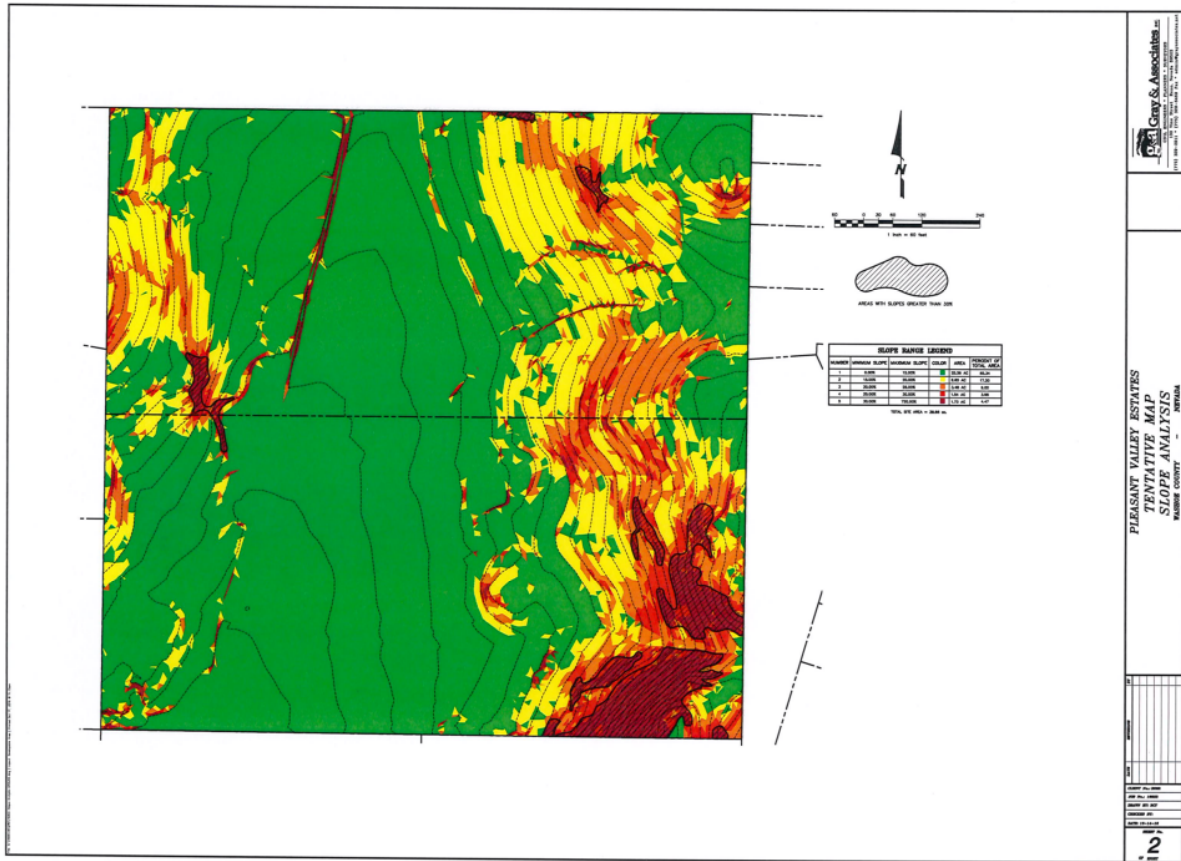

Figure 5 – Slope Analysis

(g) Soil. An analysis of the soil characteristics of the site using Soil Conservation Service (SCS) information.

The site characteristics are comparable to surrounding developed areas, which have shown no soil or geologic conditions that would preclude residential development at the densities proposed.

(h) Natural Drainageways. Identification of natural drainageways on and adjacent to the site.

Natural drainage that occurs within the site will be retained and is incorporated into the provided open space. A detailed hydrology study is also included as an appendix to this report.

(i) Wetlands and Water Bodies. Identification of existing or potential wetlands and water bodies on the site.

Not applicable. No wetlands or water bodies exist onsite.

- (j) Flood Hazards. Identification of existing and potential flood hazards using Federal Emergency Management Agency (FEMA) information.

There are no flood hazard areas within the Pleasant Valley Estates site.

- (k) Seismic Hazards. Identification of seismic hazards on or near the site, including location of Holocene faults.

The site characteristics are comparable to surrounding developed areas, which have shown no geologic conditions that would preclude residential development at the densities proposed.

- (l) Avalanche Hazards. An analysis of avalanche and other landslide hazards.

The site characteristics are comparable to surrounding developed areas, which have shown no avalanche hazards that would preclude residential development at the densities proposed.

- (m) Sensitive Habitat and Migration Routes. An analysis of sensitive habitat areas and migration routes.

Not applicable. There are no known or identified sensitive habitats or migration routes onsite.

- (n) Significant Views. A description and analysis of all on and off site significant views.

Views across the property are previously depicted in Figure 2. In general, houses in the area enjoy views of surrounding mountains, including Slide Mountain and Mt. Rose to the west. Housing lots in this tentative map will be able to take advantage of these views without impacting the views from existing houses. This is due to the continuously variable terrain of the area and substantial southern and southwestern exposure of the area.

- (o) Easements. A description of the type and location of any easements on the site.

All existing and proposed easements are clearly depicted on the engineering plans included with this report. Additionally, a preliminary title report is being submitted with the original report that identifies and describes all existing easements.

- (p) Utilities. A description of existing or available utilities, and an analysis of appropriate locations for water, power, sanitary sewer and storm water sewer services.

The attached engineering plans and drawings depict all existing utilities/infrastructure and proposed extensions, etc. The project will connect to all municipal services including sewer, water, natural gas, cable television, etc.

(q) Appropriate Access Points. An analysis of appropriate access points based upon existing and proposed streets and highways and site opportunities and constraints.

Primary access is provided from Chance Lane with secondary access from Rocky Vista Road. The primary access is situated and sized such that conflicts with existing driveways and circulation patterns will not result.

(r) Other Information. All other information deemed appropriate and necessary by the Director of Community Development.

This report provides for all pertinent and required details. Additional information and analysis can be provided on an as-needed basis as it may arise during the public review process.

Hillside:

Article 424 of the Washoe County Development Code establishes regulations related to Hillside Development. Specifically, Section 110.424.15(a) requires a site analysis be conducted. This site analysis criteria is listed below and addressed in **bold face** type.

Section 110.424.15(a) Site Analysis. A site analysis, prepared by a qualified engineer, planner, landscape architect, or architect shall be submitted. This analysis shall provide the basis for assessing the opportunities and constraints of the site for development and shall be in the form of a design standards handbook incorporating both textual and graphical representations of the requested action. At a minimum, a site analysis shall include:

- (1) Major topographic conditions including ridgelines, ravines, canyons, and knolls.

The site does contain significant topographic features with part of it being considered a hillside. The engineering plans included with this application provide for grading and drainage plans that clearly depict the site topography.

- (2) Preliminary geological conditions including major rock outcroppings, slide areas, and areas underlain with faults that have been active during the Holocene epoch of geological time.

The site characteristics are comparable to surrounding developed areas, which have shown no geologic conditions that would preclude residential development at the densities proposed. A large boulder is located near the western edge of the site which is being left in place due to some culturally significant markings. An open space lot and access trail have been created to provide the public access to this boulder.

- (3) Preliminary soil conditions including soil type, expansiveness, slumping, erodibility, and permeability.

The site characteristics are comparable to surrounding developed areas, which have shown no soil or geologic conditions that would preclude residential development at the densities proposed. Foundation requirements for each individual unit will be determined as part of the Final Map.

- (4) Significant surface hydrological conditions including natural drainage courses, perennial streams, floodplains, wetlands, and ponding areas.

Natural drainage that occurs within the site will be retained and is incorporated into the provided open space. Hydrology information is shown on the grading/drainage plan.

- (5) The location and types of significant vegetation including known rare and endangered plant species and general plant communities.

Initial examination indicates that the site vegetation is typical brush-type plants found throughout the area. No known rare and/or endangered plant species are found onsite.

- (6) Habitat areas for rare or endangered animal species.

Initial examination indicates that there are no known rare or endangered animal species on the site. Typical animals such as rabbits, mice, and coyotes are the only known fauna in the immediate vicinity.

- (7) Preliminary viewshed analysis including cross sections of views to and from the development site from all major roadways within one (1) mile of the project site, and from major focal points on the project site.

Views across the property are previously depicted in Figure 2. In general, houses in the area enjoy views of surrounding mountains, including Slide Mountain and Mt. Rose to the west. Housing lots in this tentative map will be able to take advantage of these views without impacting the views from existing houses. This is due to the continuously variable terrain of the area and substantial southern and southwestern exposure of the area.

- (8) How the development responds to the unique conditions of the hillside.

The tentative subdivision map responds to the unique conditions of the hillside by creating a common open space area where no houses will be located.

- (9) A slope analysis, submitted on a topographic map with contour intervals of a least five (5) feet for planning purposes. This analysis shall indicate the location and amount of land included with the following slope categories, tabulated in acres: 0-15 percent, 15-20 percent, 20-25 percent, 25-30 percent, greater than 30 percent.

A slope analysis (see Figure 5 above) has been prepared by the project engineer showing the amount of land following the indicated slope categories.

Potential Impacts

This section aims to provide a cursory impact analysis based on the conceptual plan developed for the project, as presented in Figure 3.

- **Schools**

As part of this Tentative Map process, the Washoe County School District was consulted as to the capacities of schools that serve the project area. It was determined that the project site is zoned for the following schools:

- Pleasant Valley Elementary School
- Depoali Middle School
- Damonte Ranch High School

Washoe County School District provided the School District's accepted student generation formulas. Assuming a total of 54 lots, the following table summarizes potential school impacts.

School	Generation Rate ¹	Number of New Students
Pleasant Valley Elem. School	0.277/unit	15 students
Depoali Middle School	0.064/unit	4 students
Damonte Ranch High School	0.136/unit	8 students

¹ – provided by the Washoe County School District.

It is important to note that this analysis does not consider the potential for children to attend charter schools, private institutions, or home schooling and is therefore a worst-case scenario in terms of student generation projections. In addition, school impacts will now be addressed regionally with the recent passing of WC-1, which is intended to provide funding for new schools throughout Washoe County.

- **Public Facilities/Infrastructure**

The project site is located in an area of existing infrastructure. All municipal services (i.e. water, sewer, storm drain, etc.) are either in place or can easily be extended (at the developer's expense) to serve

PLEASANT VALLEY ESTATES

Pleasant Valley Estates. All new lots within Pleasant Valley Estates will be served by municipal water and sewer. Power, natural gas, cable television, and high speed internet service all exist at or adjacent to the project site.

Another noteworthy point is that the proposed clustering of units (through a common open space subdivision) will result in resource conservation, reduction in water use, etc. All of the applicable infrastructure is analyzed with the preliminary engineering plans and reports included with this report and compliance is demonstrated.

Preliminary utility plans are included with the engineering plans located in the map pocket of this report.

- **Public Services**

The project has been reviewed by/commented on by the Truckee Meadows Fire Protection District, which has indicated that the property is within an acceptable response time of the Truckee Meadows Fire Protection District station number 237 located on 395-A at Pagni Lane. Also, the Washoe County Sherriff's Office has existing patrols within the project area.

Planning Policy Analysis

The proposed request must be reviewed for consistency with the goals and policies of the Washoe County Master Plan and South Valleys Area Plan. Each of these planning documents is addressed below:

- **Washoe County Master Plan/South Valleys Area Plan**

The South Valleys Area Plan is an element of the Washoe County Master Plan that establishes the overall theme and vision that the community has in terms of how they wish to see the area develop over the next 20 years. Last updated in 2010, there has been very little change within the plan area in the last 5 years. However, as the region's economy continues to recover, there is now opportunity to implement change within the plan area, consistent with the goals and policies of the Area Plan.

The Introduction section of the Area Plan states that the *"South Valleys community will maintain and apply objective standards and criteria that serve to manage growth and development in South Valleys in a manner that:*

- *Respects the scenic and rural heritage of the area by encouraging architectural and site design standards that are responsive to this heritage;*
- *Maintains a rural agricultural character in the landscape between the urban areas of Reno and Carson City;*
- *Respects private property rights;*
- *Provides a limited range of housing opportunities complementary to the area's rural and historic character;*

PLEASANT VALLEY ESTATES

- *Encourages the development of commercial opportunities in a manner that helps define the community, provide needed services, and otherwise highlight the character of the community as defined by the Lane Use Table in Appendix A;*
- *Provides ample open space and recreational opportunities;*
- *Promotes the educational and scientific opportunities inherent in the area's natural history and rural character;*
- *Addresses the conservation of natural, scenic, and cultural resources;*
- *Ensures that infrastructure in coincident with development and appropriate in scale and character to the community character articulated below; and*
- *Coordinates resource availability with the construction of infrastructure through the implementation of facilities and resources plans.*

This Tentative Map request is entirely consistent with this intent of the Area Plan. Pleasant Valley Estates will provide residential uses that will complement existing development patterns in the area as well as provide significant open space and linkages to informal trails in the area. The existing cultural resource on the site will be kept in place within an accessible open space area for residents and the public to enjoy. Infrastructure including streets and utilities will be improved and/or provided in the appropriate scale for the development, while complying with Washoe County standards.

The project site is located within the Steamboat Valley Rural Transition Character Management Area defined in the Area Plan. This "transition zone" as discussed in the area plan specifies that in the areas "*{t}o the north and east of Rhodes Road, the densities and land use patterns should provide a transition to the urban land use patterns likely to be implemented in the incorporated areas north of Rhodes Road.*" The density proposed with Pleasant Valley Estates is consistent with the MDS zoning maximum of 3 du/ac (1.37 du/ac proposed) identified in the plan and provides for an appropriate transition to adjoining properties and City of Reno development to the north.

The Area Plan also contains goals and policies which are applicable to this proposed tentative map. These policies are listed below and are addressed in **bold face** type.

Goal One: The pattern of land use designations in the South Valleys Area Plan will implement and preserve the community character described in the Character Statement.

As described in the previous section, Pleasant Valley Estates conforms to the Character Statement in terms of location within the Steamboat Valley Rural Transition Character Management Area, allowable suburban densities, preservation of open space, informal trail connections, and resource conservation.

Goal Two: Common Development Standards in the South Valleys planning area. Establish development guidelines that will implement and preserve the community character commonly found within the South Valleys planning area.

As described earlier, Pleasant Valley Estates has been designed to be complementary to surrounding

uses and properties, keeping the community character intact.

SV.2.2: Whenever possible, grading for residential purposes after the date of final adoption of this plan will: a) minimize disruption to natural topography; b) utilize natural contours and slopes; c) complement the natural characteristics of the landscape; d) preserve existing vegetation and ground coverage to minimize erosion; and e) minimize cuts and fills.

Pleasant Valley Estates has been designed to minimize disruption to the natural topography, utilize natural contours, and minimize cuts and fills by creating a large open space lot on the portion of the site with the steepest slopes. This area will also serve to preserve natural characteristics and existing vegetation.

SV.2.14: Development activities should be designed to support the efficient use of infrastructure and the conservation of recharge areas, habitat, and open vistas.

Access to the site is located along existing roadways within the area, making efficient use of that infrastructure. Future utility infrastructure will tie into existing lines already in place in the surrounding area. No recharge areas or significant habitat are located on the site.

SV.3.5: Potential historic and cultural resources exist throughout the Steamboat Valley Community. Development should be preceded by efforts to identify cultural and historical resources and provide for their conservation.

A large boulder with historical markings is located within the project site. To preserve this cultural/historic resource, a separate open space lot has been created near the western edge of the site. This will provide an area for people to view the rock without disturbing it.

SV.3.6: Emergency or secondary access from the Toll Road area to U.S. 395 via Rhodes Road or other feasible location is desired. Development proposals in this general area should be examined for their ability to provide this access. New development should not be permitted to prevent this access from being established.

The design of Pleasant Valley Estates includes the development of an additional stretch of Chance Lane that does not currently exist. This extension of Chance Lane brings the desired access from Toll Road to Highway 395-A that much closer to reality.

Tentative Map Findings

Section 110.608.20 of the Washoe County Development Code establishes legal findings that must be made by the Planning Commission or Board of County Commissioners in order to approve a Tentative Map request. These findings are listed below and are addressed in **bold face** type.

PLEASANT VALLEY ESTATES

- (a) Environmental and Health Laws. Environmental and health laws and regulations concerning water and air pollution, the disposal of solid waste, facilities to supply water, community or public sewage disposal and, where applicable, individual systems for sewage disposal;

Pleasant Valley Estates will be served by municipal water and sewer service, ensuring full compliance with this finding. Additionally, solid waste disposal service will be provided through Waste Management which currently operates routes in Pleasant Valley and the surrounding areas.

- (b) Availability of Water. The availability of water which meets applicable health standards as well as requirements for water rights, quality or will-serve commitments;

The project site is within the service boundary of the Truckee Meadows Water Authority and has completed a Discovery process through TMWA. Water rights will be dedicated to TMWA to serve the project, ensuring full compliance with this finding. Water rights can be purchased directly from TMWA or on the open market (with full TMWA acceptance).

- (c) Utilities. The availability and accessibility of utilities;

The project will be served by all municipal utilities, infrastructure, and services as detailed within this report and on the attached engineering plans.

- (d) Public Services. The availability and accessibility of public services such as schools, police and fire protection, transportation, recreation and parks;

The project is within an acceptable response time of the Truckee Meadows Fire Protection District's station number 237 located on Highway 395-A at Pagni Lane and is in an area of existing Sherriff patrols. Schools that will serve the project along with the anticipated number of new students are detailed within this report. It is further recognized that it will be disclosed to all new residents (at time of purchase) that school zoning is subject to change based on current enrollments, capacities, etc.

- (e) Plan Consistency. General conformance with the Development Code and Master Plan;

Pleasant Valley Estates will provide residential uses that will complement existing development patterns in the area as well as provide significant open space and linkages to informal trails in the area. The existing cultural resource on the site will be kept in place within an accessible open space area for residents and the public to enjoy. Infrastructure including streets and utilities will be improved and/or provided in the appropriate scale for the development, while complying with Washoe County standards.

- (f) Impact on Existing Streets. The effect of the proposed subdivision on existing public streets and the need for new streets or highways to serve the subdivision;

PLEASANT VALLEY ESTATES

As part of this project, Chance Lane will be improved to conform with Washoe County standards. The amount of AM and PM peak trips created by this subdivision does not warrant the need for a traffic study to examine any impacts to other existing roads such as Rhodes Road or Highway 395-A.

- (g) Physical Characteristics. Physical characteristics of the land such as flood plain, slope and soil;

The site is well suited for the type and intensity of development proposed. The site contains no slope or soil conditions that would preclude development nor does it contain any significant wildlife habitats, etc. Drainage will be directed into a detention basin so as not to impact downstream parcels. The hillside area is incorporated into the provided open space and will not impact individual lots within the project.

- (h) Agency Review. The recommendations and comments of the entities reviewing the tentative map; and

Copies of this report and the included plans will be circulated to all applicable reviewing agencies for review and comment. Specific requirements and relevant comments can be included as conditions tied to this request and implemented with final map(s).

- (i) Impact on Existing Drainage System. The effect of the proposed subdivision on the existing natural and man-made drainage system.

The project will provide for onsite detention to ensure that no additional flows over what currently exist will occur from the site with development of Pleasant Valley Estates. A highly detailed hydrology study is also included in the appendices of this report demonstrating compliance with all applicable Washoe County requirements related to drainage.







FOR SALE

16100*



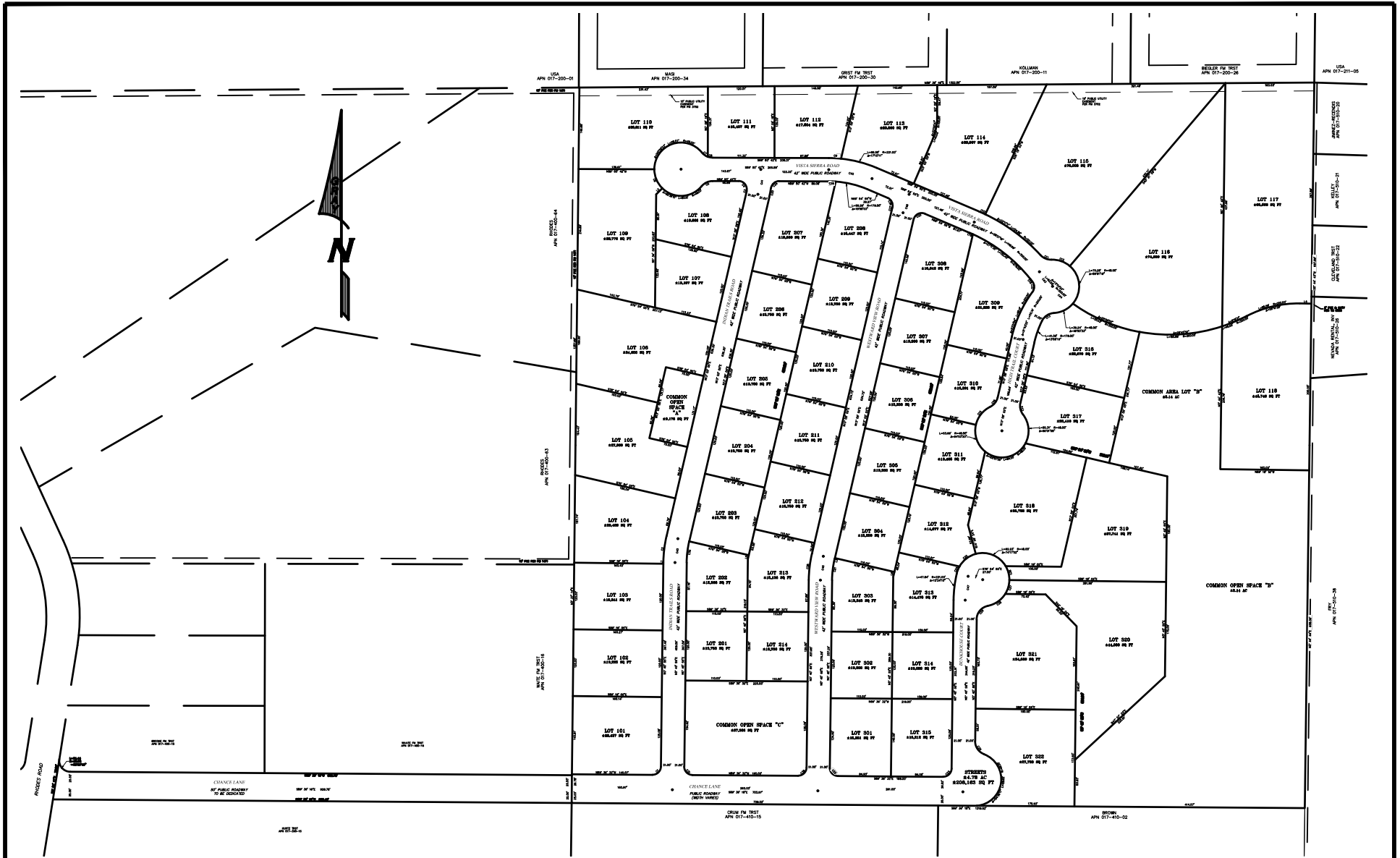

PLEASANT VALLEY ESTATES
TENTATIVE MAP
OVERALL VIEW

SCALE: 1"=250'

DRAWN BY: ECT

DATE: 11-15-16

JOB NO.: 16003



Gray & Associates INC.

CIVIL ENGINEERS * PLANNERS * SURVEYORS

130 Vine Street Reno, Nevada 89503

(775) 329-2911 * (775) 329-6469 Fax * admin@grayassociates.net

Community Services Department
Planning and Development
TENTATIVE SUBDIVISION MAP
APPLICATION



Community Services Department
Planning and Development
1001 E. Ninth St., Bldg A
Reno, NV 89520

Telephone: 775.328.3600

Washoe County Development Application

Your entire application is a public record. If you have a concern about releasing personal information, please contact Planning and Development staff at 775.328.3600.

Project Information		Staff Assigned Case No.: _____	
Project Name:			
Project Description:			
Project Address:			
Project Area (acres or square feet):			
Project Location (with point of reference to major cross streets AND area locator):			
Assessor's Parcel No.(s):	Parcel Acreage:	Assessor's Parcel No(s):	Parcel Acreage:
Section(s)/Township/Range:			
Indicate any previous Washoe County approvals associated with this application:			
Case No.(s).			
Applicant Information (attach additional sheets if necessary)			
Property Owner:		Professional Consultant:	
Name:		Name:	
Address:		Address:	
Zip:		Zip:	
Phone: Fax:		Phone: Fax:	
Email:		Email:	
Cell: Other:		Cell: Other:	
Contact Person:		Contact Person:	
Applicant/Developer:		Other Persons to be Contacted:	
Name:		Name:	
Address:		Address:	
Zip:		Zip:	
Phone: Fax:		Phone: Fax:	
Email:		Email:	
Cell: Other:		Cell: Other:	
Contact Person:		Contact Person:	
For Office Use Only			
Date Received: Initial:		Planning Area:	
County Commission District:		Master Plan Designation(s):	
CAB(s):		Regulatory Zoning(s):	

Tentative Subdivision Map Application Supplemental Information

(All required information may be separately attached)

Chapter 110 of the Washoe County Code is commonly known as the Development Code. Specific references to tentative subdivision maps may be found in Article 608, Tentative Subdivision Maps.

1. What is the location (address or distance and direction from nearest intersection)?

2. What is the subdivision name (proposed name must not duplicate the name of any existing subdivision)?

3. Density and lot design:

a. Acreage of project site	
b. Total number of lots	
c. Dwelling units per acre	
d. Minimum and maximum area of proposed lots	
e. Minimum width of proposed lots	
f. Average lot size	

4. Utilities:

a. Sewer Service	
b. Electrical Service	
c. Telephone Service	
d. LPG or Natural Gas Service	
e. Solid Waste Disposal Service	
f. Cable Television Service	
g. Water Service	

5. For common open space subdivisions (Article 408), please answer the following:

a. Acreage of common open space:

b. Development constraints within common open space (slope, wetlands, faults, springs, ridgelines):

c. Range of lot sizes (include minimum and maximum lot size):

d. Average lot size:

e. Proposed yard setbacks if different from standard:

f. Justification for setback reduction or increase, if requested:

g. Identify all proposed non-residential uses:

h. Improvements proposed for the common open space:

i. Describe or show on the tentative map any public or private trail systems within common open space of the development:

j. Describe the connectivity of the proposed trail system with existing trails or open space adjacent to or near the property:

k. If there are ridgelines on the property, how are they protected from development?

l. Will fencing be allowed on lot lines or restricted? If so, how?

m. Identify the party responsible for maintenance of the common open space:

--

6. Is the project adjacent to public lands or impacted by "Presumed Public Roads" as shown on the adopted April 27, 1999 Presumed Public Roads (see Washoe County Engineering website at <http://www.washoecounty.us/pubworks/engineering.htm>). If so, how is access to those features provided?

--

7. Is the parcel within the Truckee Meadows Service Area?

<input type="checkbox"/> Yes	<input type="checkbox"/> No
------------------------------	-----------------------------

8. Is the parcel within the Cooperative Planning Area as defined by the Regional Plan?

<input type="checkbox"/> Yes	<input type="checkbox"/> No	If yes, within what city?
------------------------------	-----------------------------	---------------------------

9. Will a special use permit be required for utility improvement? If so, what special use permits are required and are they submitted with the application package?

--

10. Has an archeological survey been reviewed and approved by SHPO on the property? If yes, what were the findings?

--

11. Indicate the type and quantity of water rights the application has or proposes to have available:

a. Permit #		acre-feet per year	
b. Certificate #		acre-feet per year	
c. Surface Claim #		acre-feet per year	
d. Other #		acre-feet per year	

e. Title of those rights (as filed with the State Engineer in the Division of Water Resources of the Department of Conservation and Natural Resources):

12. Describe the aspects of the tentative subdivision that contribute to energy conservation:

13. Is the subject property in an area identified by Planning and Development as potentially containing rare or endangered plants and/or animals, critical breeding habitat, migration routes or winter range? If so, please list the species and describe what mitigation measures will be taken to prevent adverse impacts to the species:

14. If private roads are proposed, will the community be gated? If so, is a public trail system easement provided through the subdivision?

15. Is the subject property located adjacent to an existing residential subdivision? If so, describe how the tentative map complies with each additional adopted policy and code requirement of Article 434, Regional Development Standards within Cooperative Planning Areas and all of Washoe County, in particular, grading within 50 and 200 feet of the adjacent developed properties under 5 acres and parcel matching criteria:

16. Are there any applicable policies of the adopted area plan in which the project is located that require compliance? If so, which policies and how does the project comply?

17. Are there any applicable area plan modifiers in the Development Code in which the project is located that require compliance? If so, which modifiers and how does the project comply?

18. Will the project be completed in one phase or is phasing planned? If so, please provide that phasing plan:

--

19. Is the project subject to Article 424, Hillside Development? If yes, please address all requirements of the Hillside Ordinance in a separate set of attachments and maps.

<input type="checkbox"/> Yes	<input type="checkbox"/> No	If yes, include a separate set of attachments and maps.
------------------------------	-----------------------------	---

20. Is the project subject to Article 418, Significant Hydrologic Resources? If yes, please address Special Review Considerations within Section 110.418.30 in a separate attachment.

<input type="checkbox"/> Yes	<input type="checkbox"/> No	If yes, include separate attachments.
------------------------------	-----------------------------	---------------------------------------

Grading

Please complete the following additional questions if the project anticipates grading that involves: (1) Disturbed area exceeding twenty-five thousand (25,000) square feet not covered by streets, buildings and landscaping; (2) More than one thousand (1,000) cubic yards of earth to be imported and placed as fill in a special flood hazard area; (3) More than five thousand (5,000) cubic yards of earth to be imported and placed as fill; (4) More than one thousand (1,000) cubic yards to be excavated, whether or not the earth will be exported from the property; or (5) If a permanent earthen structure will be established over four and one-half (4.5) feet high:

21. How many cubic yards of material are you proposing to excavate on site?

--

22. How many cubic yards of material are you exporting or importing? If exporting of material is anticipated, where will the material be sent? If the disposal site is within unincorporated Washoe County, what measures will be taken for erosion control and revegetation at the site? If none, how are you balancing the work on-site?

--

23. Can the disturbed area be seen from off-site? If yes, from which directions, and which properties or roadways? What measures will be taken to mitigate their impacts?

24. What is the slope (Horizontal:Vertical) of the cut and fill areas proposed to be? What methods will be used to prevent erosion until the revegetation is established?

25. Are you planning any berms and, if so, how tall is the berm at its highest? How will it be stabilized and/or revegetated?

26. Are retaining walls going to be required? If so, how high will the walls be, will there be multiple walls with intervening terracing, and what is the wall construction (i.e. rockery, concrete, timber, manufactured block)? How will the visual impacts be mitigated?

27. Will the grading proposed require removal of any trees? If so, what species, how many, and of what size?

28. What type of revegetation seed mix are you planning to use and how many pounds per acre do you intend to broadcast? Will you use mulch and, if so, what type?

29. How are you providing temporary irrigation to the disturbed area?

30. Have you reviewed the revegetation plan with the Washoe Storey Conservation District? If yes, have you incorporated their suggestions?

Tahoe Basin

Please complete the following additional questions if the project is within the Tahoe Basin:

31. Who is the Tahoe Regional Planning Agency (TRPA) project planner and what is his/her TRPA extension?

--

32. Is the project within a Community Plan (CP) area?

<input type="checkbox"/> Yes	<input type="checkbox"/> No	If yes, which CP?
------------------------------	-----------------------------	-------------------

33. State how you are addressing the goals and policies of the Community Plan for each of the following sections:

- a. Land Use:

--

- b. Transportation:

--

- c. Conservation:

--

d. Recreation:

--

e. Public Services:

--

34. Identify where the development rights for the proposed project will come from:

--

35. Will this project remove or replace existing housing?

<input type="checkbox"/> Yes	<input type="checkbox"/> No	If yes, how many units?
------------------------------	-----------------------------	-------------------------

36. How many residential allocations will the developer request from Washoe County?

--

37. Describe how the landscape plans conform to the Incline Village General Improvement District landscaping requirements:

--

Request to Reserve New Street Name(s)

The Applicant is responsible for all sign costs.

Applicant Information

Name: _____
Address: _____

Phone : _____ Fax: _____
Private Citizen Agency/Organization

Street Name Requests

(No more than 14 letters or 15 if there is an "i" in the name. Attach extra sheet if necessary.)

If final recordation has not occurred within one (1) year, it is necessary to submit a written request for extension to the coordinator prior to the expiration date of the original

Location

Project Name: _____
Reno Sparks Washoe County
Parcel Numbers: _____
Subdivision Parcelization Private Street

Please attach maps, petitions and supplementary information.

Approved: _____ Date: _____
Regional Street Naming Coordinator
Except where noted
Denied: _____ Date: _____
Regional Street Naming Coordinator

Washoe County Geographic Information Services

Post Office Box 11130 - 1001 E. Ninth Street
Reno, NV 89520-0027

Phone: (775) 328-2325 - Fax: (775) 328-6133

Property Owner Affidavit

Applicant Name: Harry C. Fry

The receipt of this application at the time of submittal does not guarantee the application complies with all requirements of the Washoe County Development Code, the Washoe County Master Plan or the applicable area plan, the applicable regulatory zoning, or that the application is deemed complete and will be processed.

STATE OF NEVADA)
COUNTY OF WASHOE)

I, Harry C Fry (please print name)

being duly sworn, depose and say that I am the owner* of the property or properties involved in this application as listed below and that the foregoing statements and answers herein contained and the information herewith submitted are in all respects complete, true, and correct to the best of my knowledge and belief. I understand that no assurance or guarantee can be given by members of Planning and Development.

(A separate Affidavit must be provided by each property owner named in the title report.)

Assessor Parcel Number(s): APN 017-410-38 & 39

Printed Name Harry C. Fry

Signed Harry C. Fry

Address 761 Greenbrae Dr. Sparks, NV 89431

Subscribed and sworn to before me this 8th day of November, 2016.

Deanna L. McAninch
Notary Public in and for said county and state

My commission expires: 4/26/2017

(Notary Stamp)

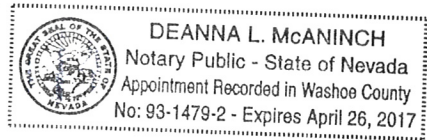

*Owner refers to the following: (Please mark appropriate box.)

- Owner
 Corporate Officer/Partner (Provide copy of record document indicating authority to sign.)
 Power of Attorney (Provide copy of Power of Attorney.)
 Owner Agent (Provide notarized letter from property owner giving legal authority to agent.)
 Property Agent (Provide copy of record document indicating authority to sign.)
 Letter from Government Agency with Stewardship

Washoe County Treasurer
 Tammi Davis

Bill Detail

Washoe County Parcel Information		
Parcel ID	Status	Last Update
01741038	Active	11/10/2016 2:10:06 AM
Current Owner: PLEASANT VALLEY ESTATES LLC 301 FLINT ST RENO, NV 89501		SITUS: 16100 ROCKY VISTA RD WASHOE COUNTY NV
Taxing District 4000		Geo CD:
Legal Description		
Block Range 20 SubdivisionName _UNSPECIFIED Township 17 Section Lot A		

Installments						
Period	Due Date	Tax Year	Tax	Penalty/Fee	Interest	Total Due
INST 1	8/15/2016	2016	\$0.00	\$0.00	\$0.00	\$0.00
INST 2	10/3/2016	2016	\$0.00	\$0.00	\$0.00	\$0.00
INST 3	1/2/2017	2016	\$454.05	\$0.00	\$0.00	\$454.05
INST 4	3/6/2017	2016	\$454.04	\$0.00	\$0.00	\$454.04
Total Due:			\$908.09	\$0.00	\$0.00	\$908.09

Tax Detail			
	Gross Tax	Credit	Net Tax
State of Nevada	\$95.20	\$0.00	\$95.20
Truckee Meadows Fire Dist	\$302.40	\$0.00	\$302.40
Washoe County	\$779.34	\$0.00	\$779.34
Washoe County Sc	\$637.56	\$0.00	\$637.56
PLEASANT VALLEY WATER BASIN	\$1.69	\$0.00	\$1.69
Total Tax	\$1,816.19	\$0.00	\$1,816.19

Payment History				
Tax Year	Bill Number	Receipt Number	Amount Paid	Last Paid
2016	2016131704	B16.130010	\$454.05	10/10/2016
2016	2016131704	B16.72186	\$454.05	8/24/2016

Pay By Check

Please make checks payable to:
WASHOE COUNTY TREASURER

Mailing Address:
 P.O. Box 30039
 Reno, NV 89520-3039

Overnight Address:
 1001 E. Ninth St., Ste D140
 Reno, NV 89512-2845

Change of Address

All requests for a mailing address change must be submitted in writing, including a signature (unless using the online form).

To submit your address change online [click here](#)

Address change requests may also be faxed to: (775) 328-2500

Address change requests may also be mailed to:
 Washoe County Treasurer
 P O Box 30039
 Reno, NV 89520-3039

The Washoe County Treasurer's Office makes every effort to produce and publish the most current and accurate information possible. No warranties, expressed or implied, are provided for the data herein, its use, or its interpretation. If you have any questions, please contact us at (775) 328-2510 or tax@washoecounty.us

Washoe County Treasurer
 Tammi Davis

Bill Detail

[Back to Account Detail](#)

[Change of Address](#)

[Print this Page](#)

Washoe County Parcel Information		
Parcel ID	Status	Last Update
01741039	Active	11/10/2016 2:10:06 AM
Current Owner: PLEASANT VALLEY RANCH ESTATES LLC 301 FLINT ST RENO, NV 89501		SITUS: 1221 CHANCE LN WCTY NV
Taxing District 4000	Geo CD:	
Legal Description		
SubdivisionName _UNSPECIFIED Block Lot B Township 17 Range 20 Section		

Installments						
Period	Due Date	Tax Year	Tax	Penalty/Fee	Interest	Total Due
INST 1	8/15/2016	2016	\$0.00	\$0.00	\$0.00	\$0.00
INST 2	10/3/2016	2016	\$0.00	\$0.00	\$0.00	\$0.00
INST 3	1/2/2017	2016	\$752.11	\$0.00	\$0.00	\$752.11
INST 4	3/6/2017	2016	\$752.11	\$0.00	\$0.00	\$752.11
Total Due:			\$1,504.22	\$0.00	\$0.00	\$1,504.22

Tax Detail			
	Gross Tax	Credit	Net Tax
State of Nevada	\$157.75	\$0.00	\$157.75
Truckee Meadows Fire Dist	\$501.09	\$0.00	\$501.09
Washoe County	\$1,291.44	\$0.00	\$1,291.44
Washoe County Sc	\$1,056.47	\$0.00	\$1,056.47
PLEASANT VALLEY WATER BASIN	\$1.69	\$0.00	\$1.69
Total Tax	\$3,008.44	\$0.00	\$3,008.44

Payment History				
Tax Year	Bill Number	Receipt Number	Amount Paid	Last Paid
2016	2016131765	B16.62935	\$752.11	8/22/2016
2016	2016131765	B16.72287	\$752.11	8/24/2016

Pay By Check

Please make checks payable to:
WASHOE COUNTY TREASURER

Mailing Address:
 P.O. Box 30039
 Reno, NV 89520-3039

Overnight Address:
 1001 E. Ninth St., Ste D140
 Reno, NV 89512-2845

Change of Address

All requests for a mailing address change must be submitted in writing, including a signature (unless using the online form).

To submit your address change online [click here](#)

Address change requests may also be faxed to: (775) 328-2500

Address change requests may also mailed to:
 Washoe County Treasurer
 P O Box 30039
 Reno, NV 89520-3039

The Washoe County Treasurer's Office makes every effort to produce and publish the most current and accurate information possible. No warranties, expressed or implied, are provided for the data herein, its use, or its interpretation. If you have any questions, please contact us at (775) 328-2510 or tax@washoecounty.us



Truckee Meadows Water Authority

Print Date: 11/10/2016

P.O. Box 30013

Reno, NV 89520

Phone: 775-834-8080

ENGINEERING AND RESOURCES RECEIPT

Agent: Nancy Raymond

Customer: Pleasant Valley Estates LLC - Harry Fry

301 Flint St

Reno, NV 89501

Project Info:

Project Number:	Name:	Project Sub Type:
16-5262	Pleasant Valley Estates_TENT NAC	Tentative NAC

<u>DESCRIPTION</u>	<u>ACCOUNT</u>	<u>RATE</u>	<u>QUANTITY</u>	<u>PER AMOUNT</u>	<u>TENDER</u>	<u>PAID AMOUNT</u>
Acknowledgement letter - Tentative NAC	4903	100.00		\$100.00	Check	\$100.00
			Check/Ref #: 1009			\$100.00
Thank you.						
				TOTAL PAID TMWA:		\$100.00

PLL Payment Receipt Number(s): 1,164

PLEASANT VALLEY ESTATES TENTATIVE MAP APN'S 017-410-38 AND 39

PLEASANT VALLEY WASHOE COUNTY NEVADA

OWNER/APPLICANT/DEVELOPER

PLEASANT VALLEY ESTATES, LLC.
301 FLINT STREET
RENO, NV 89501
(775)846-9200

CIVIL ENGINEER



CIVIL ENGINEERS • PLANNERS • SURVEYORS
130 Vine Street Reno, Nevada 89503
(775) 829-2911 • (775) 829-6469 Fax • admin@grayassociates.net

PROJECT INFORMATION

CURRENT ZONING - MULTIPLE
- APN 017-410-38: MDS/MDR
- APN 017-410-39: LDS/MDR

PROPOSED ZONING - N/A

TOTAL LOTS - 57
RESIDENTIAL LOTS - 54
OPEN SPACE LOTS - 2
DETENTION POND LOT - 1

TOTAL PROJECT AREA - 39.34 AC.
RESIDENTIAL LOT AREA - 28.35 AC.
OPEN SPACE LOT AREA - 5.35 AC.
DETENTION POND LOT AREA - 0.86 AC
STREET AREA (TO BE DEDICATED TO WASHOE COUNTY) - 4.78 AC.

AVERAGE RESIDENTIAL LOT AREA - 0.53 AC.
MINIMUM RESIDENTIAL LOT AREA - 0.30 AC.
MAXIMUM RESIDENTIAL LOT AREA - 1.74 AC.

GROSS DENSITY - 1.37 UNITS/AC

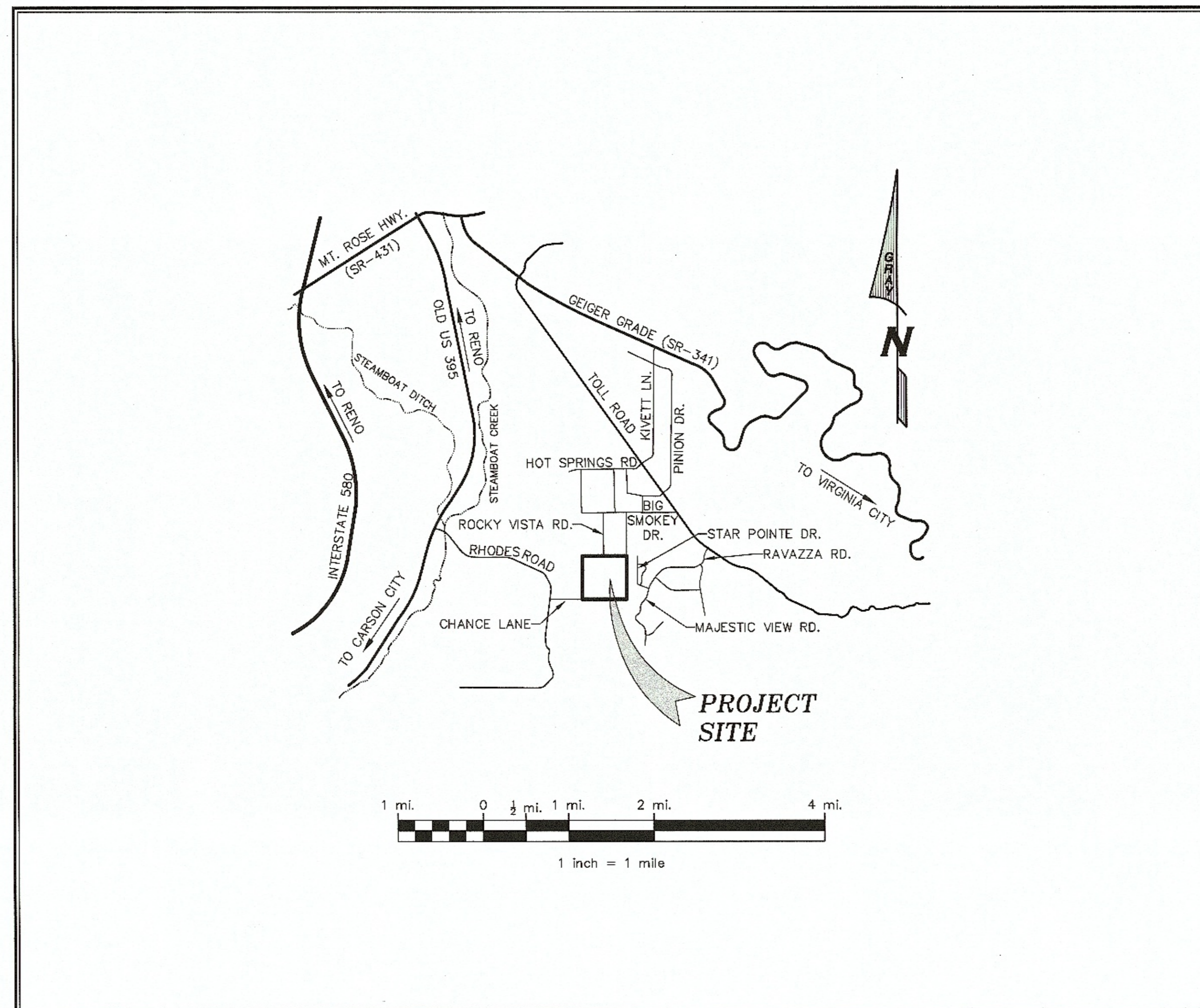

VICINITY MAP
SECTION 03, T.17., R.20E., MDM

NOVEMBER 2016

BASIS OF BEARINGS
THE BASIS OF BEARINGS FOR THIS TENTATIVE MAP APPLICATION
IS PARCEL MAP NO. 3702, RECORDED AS FILE NO. 248084,
OFFICIAL RECORDS OF WASHOE COUNTY.

SHEET INDEX

- 1 COVER SHEET
- 2 EXISTING CONDITIONS PLAN
- 3 SLOPE ANALYSIS MAP
- 4 TENTATIVE MAP
- 5 TENTATIVE MAP
- 6 TENTATIVE MAP
- 7 TENTATIVE MAP
- 8 TENTATIVE MAP
- 9 PRELIMINARY LOT AND BLOCK PLAN - SOUTH
- 10 PRELIMINARY LOT AND BLOCK PLAN - NORTH
- 11 PRELIMINARY GRADING PLAN - SOUTH
- 12 PRELIMINARY GRADING PLAN - NORTH
- 13 PRELIMINARY CROSS-SECTIONS
- 14 PRELIMINARY UTILITY PLAN - SOUTH
- 15 PRELIMINARY UTILITY PLAN - NORTH
- 16 CHANCE LANE - PRIMARY ACCESS
- 17 ROCKY VISTA ROAD - SECONDARY EMERGENCY ACCESS

GENERAL PROJECT NOTES

1. SPLIT-RAIL OR OTHER OPEN FENCING SHALL BE UTILIZED TO DELINEATE AREAS STEEPER THAN 30% ON RESIDENTIAL PARCELS.
2. SOLID SCREENING FENCING MAY BE USED FOR SIDE AND REAR YARDS THAT DON'T ADJOIN OPEN SPACE.
3. UNIMPROVED WALKING TRAILS SHALL PROVIDE ACCESS FROM PUBLIC RIGHT-OF-WAY TO THE HISTORIC ROCK WITHIN THE OPEN SPACE PARCEL ADJACENT TO LOTS 105 AND 106.

TYPICAL LOT SETBACKS

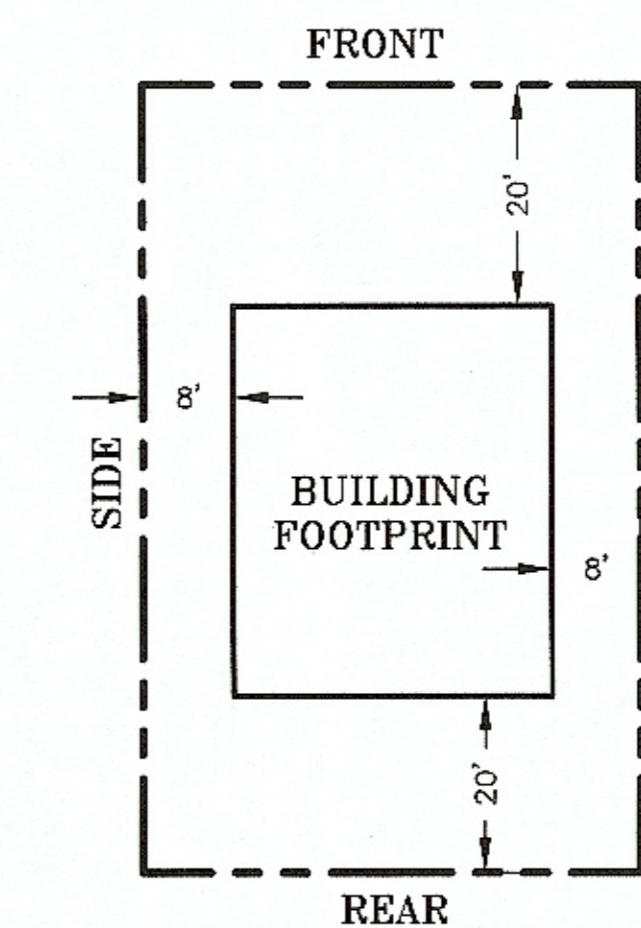

ENGINEER'S STATEMENT

TO THE BEST OF MY BELIEF, UNDERSTANDING, AND ABILITY THIS PROJECT HAS BEEN DESIGNED IN ACCORDANCE WITH WASHOE COUNTY DEVELOPMENT CODE AND IN CONFORMANCE WITH LOCAL STANDARD PRACTICES.

Edward C. Thomas 11-11-16 EDWARD C. THOMAS PE 9740

Gray & Associates, Inc.
 CIVIL ENGINEERS • PLANNERS • SURVEYORS
 130 Vine Street Reno, Nevada 89503
 (775) 829-2911 • (775) 829-6469 Fax • admin@grayassociates.net

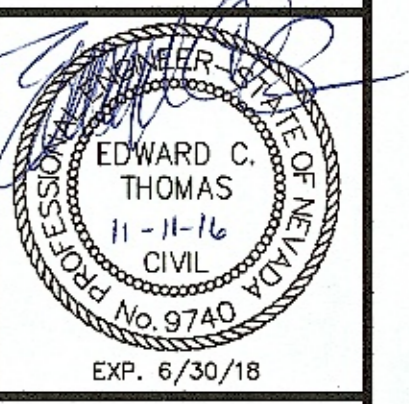

PLEASANT VALLEY ESTATES
 TENTATIVE MAP
 COVER SHEET
 WASHOE COUNTY - NEVADA

REVISIONS	DATE

CLIENT No.: P068
JOB No.: 16003
DRAWN BY: ECT
CHECKED BY:
DATE: 11-15-16

SHEET No.
1
OF SEVENTEEN

LEGEND

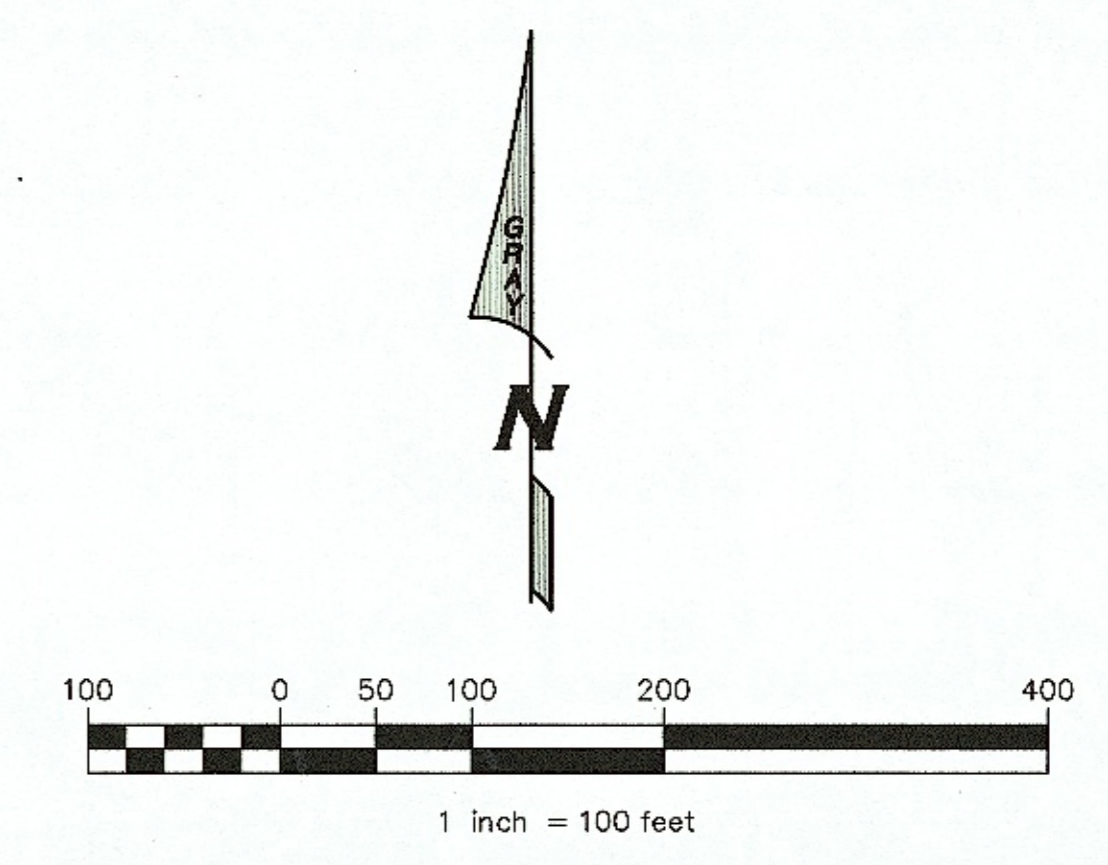
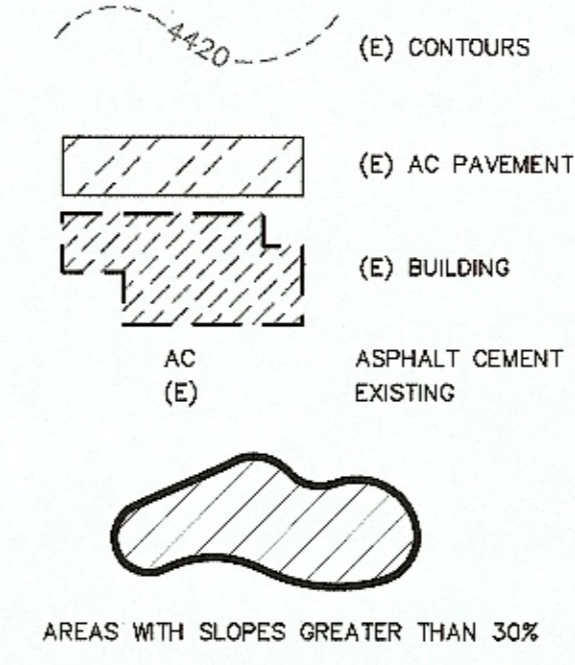

Gray & Associates, Inc.
 CIVIL ENGINEERS • PLANNERS • SURVEYORS
 1300 Van Street Reno, Nevada 89503
 (775) 829-2911 • (775) 323-6669 Fax • admin@grayassociates.net

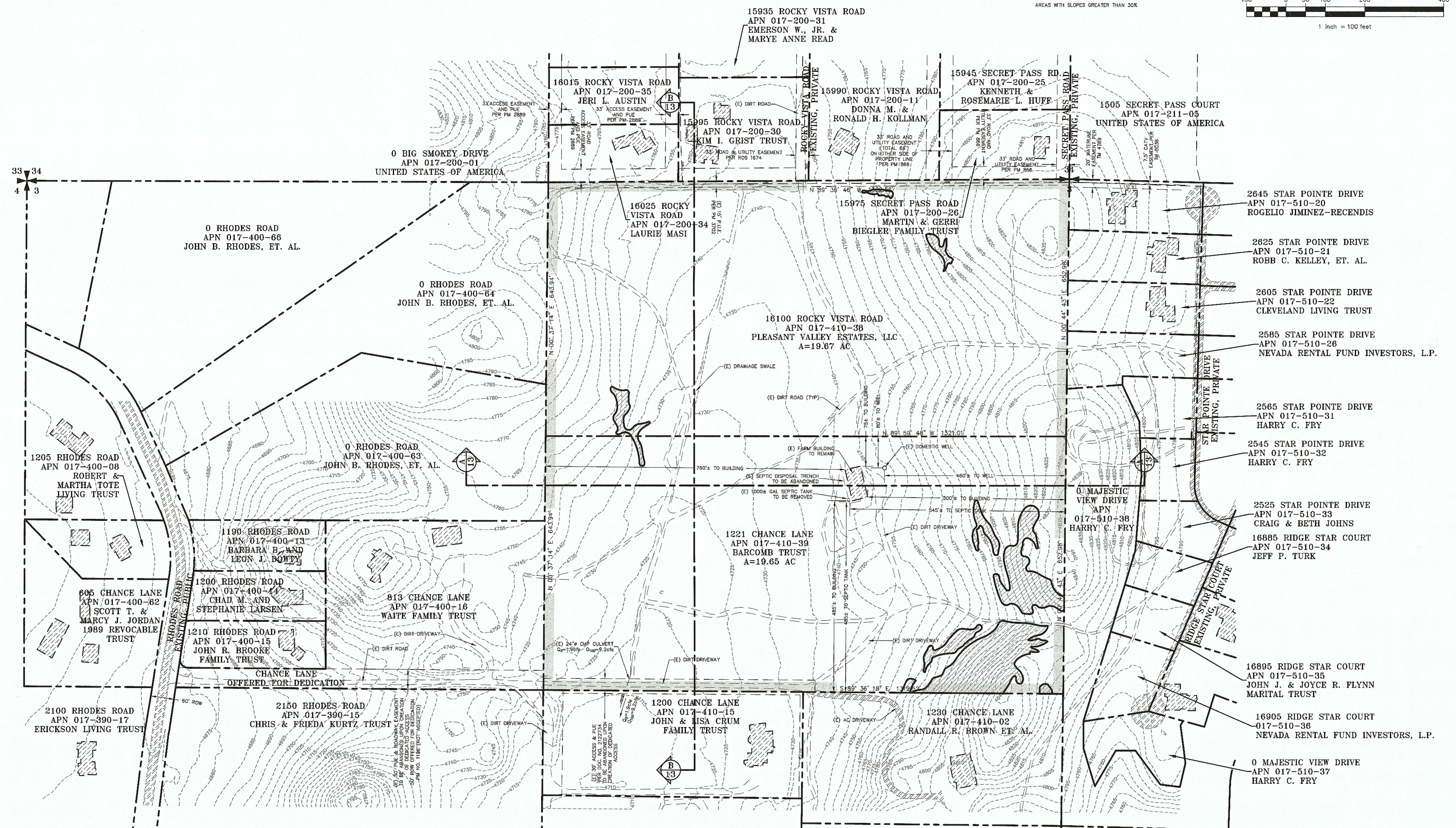
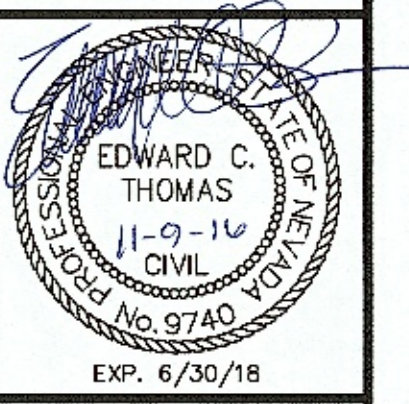

PLEASANT VALLEY ESTATES
 TENTATIVE MAP
 EXISTING SITE
 WASHOE COUNTY - NEVADA

NO.	DATE	REVISIONS

CLIENT No.: P068
 JOB No.: 16003
 DRAWN BY: BCT
 CHECKED BY:
 DATE: 11-15-16

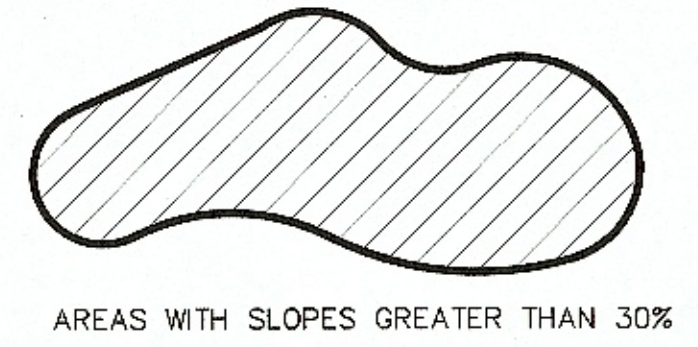
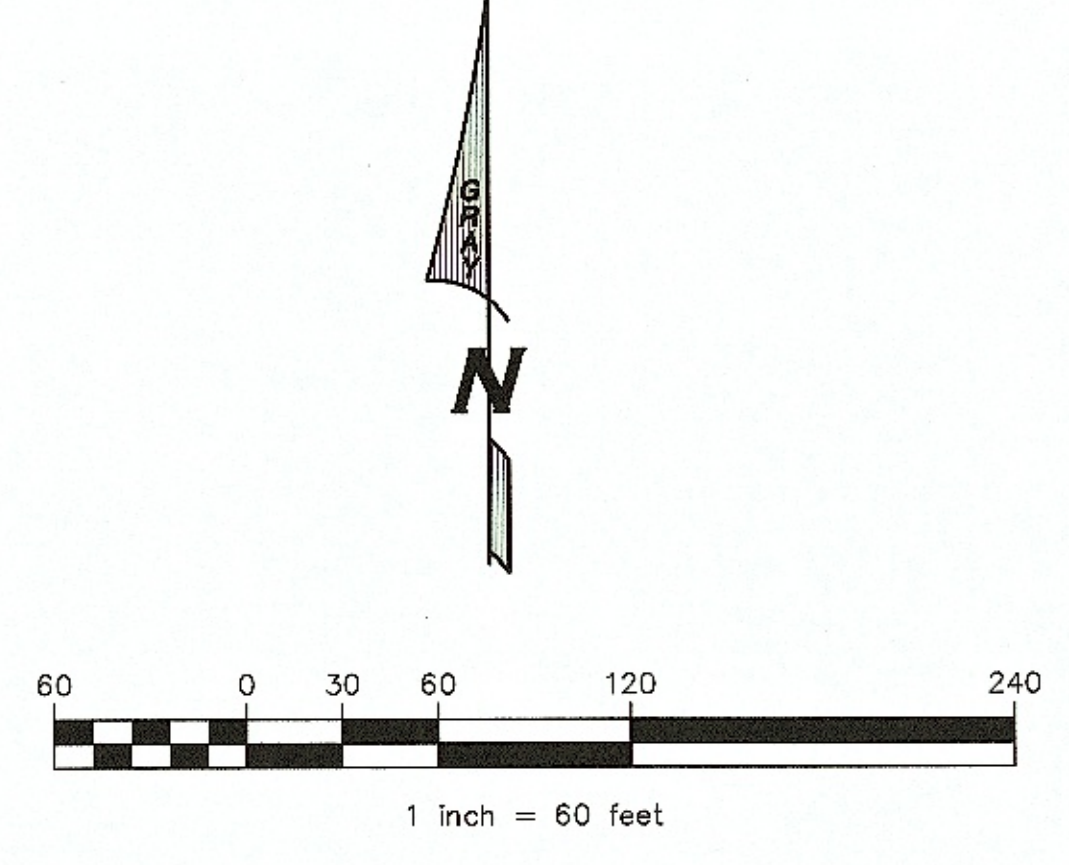
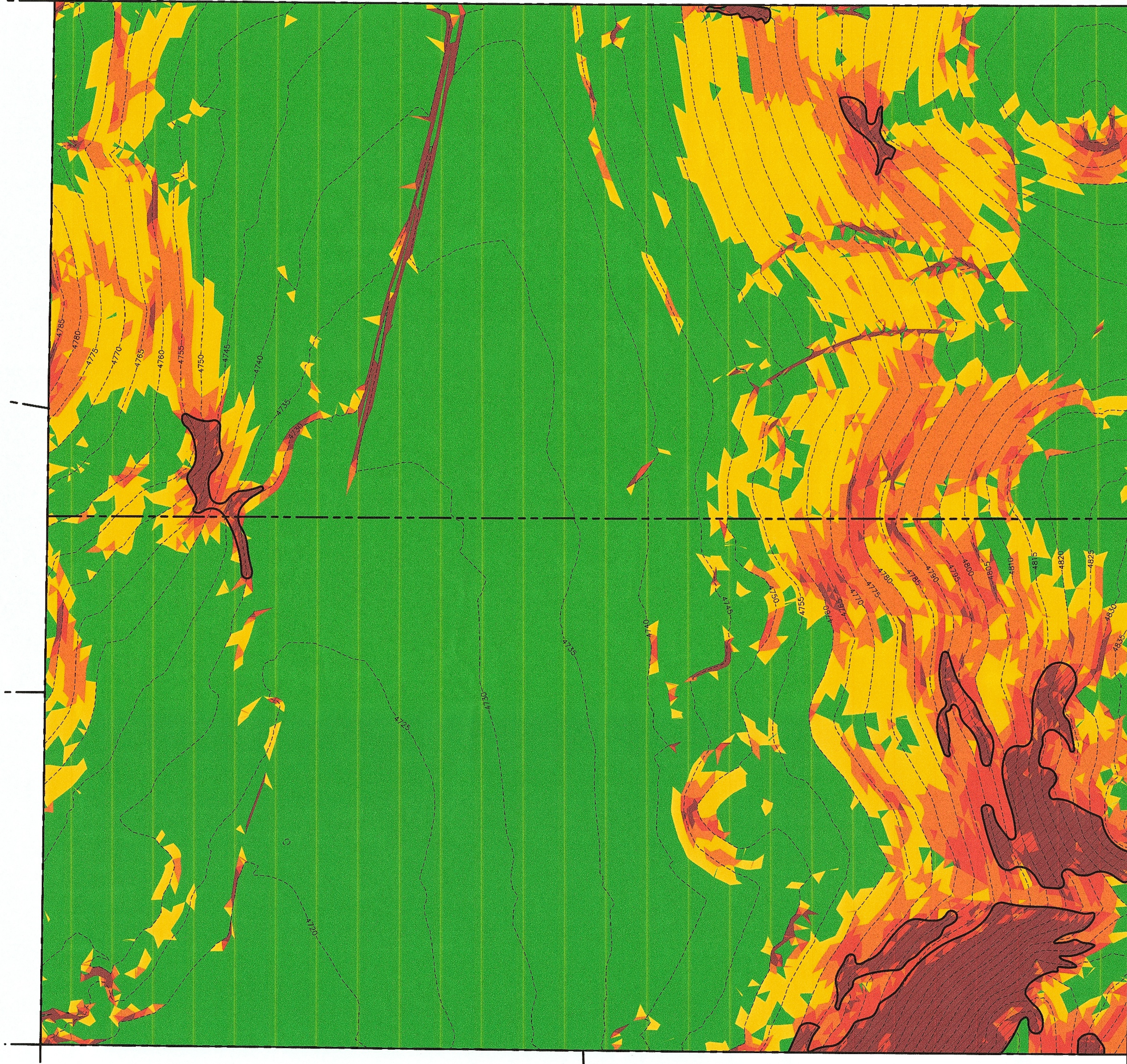

AREAS WITH SLOPES GREATER THAN 30%

SLOPE RANGE LEGEND					
NUMBER	MINIMUM SLOPE	MAXIMUM SLOPE	COLOR	AREA	PERCENT OF TOTAL AREA
1	0.00%	15.00%	Green	25.26 AC	65.34
2	15.00%	20.00%	Yellow	6.65 AC	17.20
3	20.00%	25.00%	Orange	3.48 AC	9.00
4	25.00%	30.00%	Red	1.54 AC	3.98
5	30.00%	720.00%	Dark Red	1.73 AC	4.47

TOTAL SITE AREA = 38.66 ac.

Gray & Associates INC.
 CIVIL ENGINEERS • PLANNERS • SURVEYORS
 1100 West Street, Reno, Nevada 89502
 (775) 329-9311 • (775) 329-8469 Fax • admin@grayassociates.net

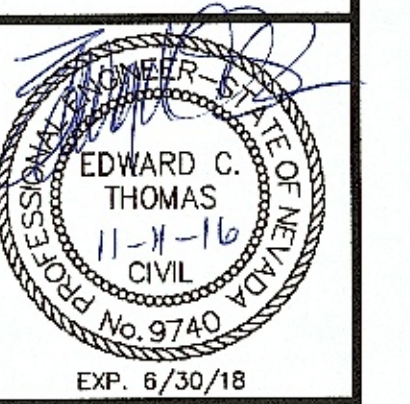

PLEASANT VALLEY ESTATES
 TENTATIVE MAP
 SLOPE ANALYSIS/DEVELOPABLE AREA
 WASHOE COUNTY - NEVADA

DATE	REVISIONS	BY

CLIENT No.: 8068
 JOB No.: 16003
 DRAWN BY: REC
 CHECKED BY:
 DATE: 11-15-16

© 2016 Gray & Associates, Inc. All rights reserved. No part of this document may be reproduced without written permission from Gray & Associates, Inc.

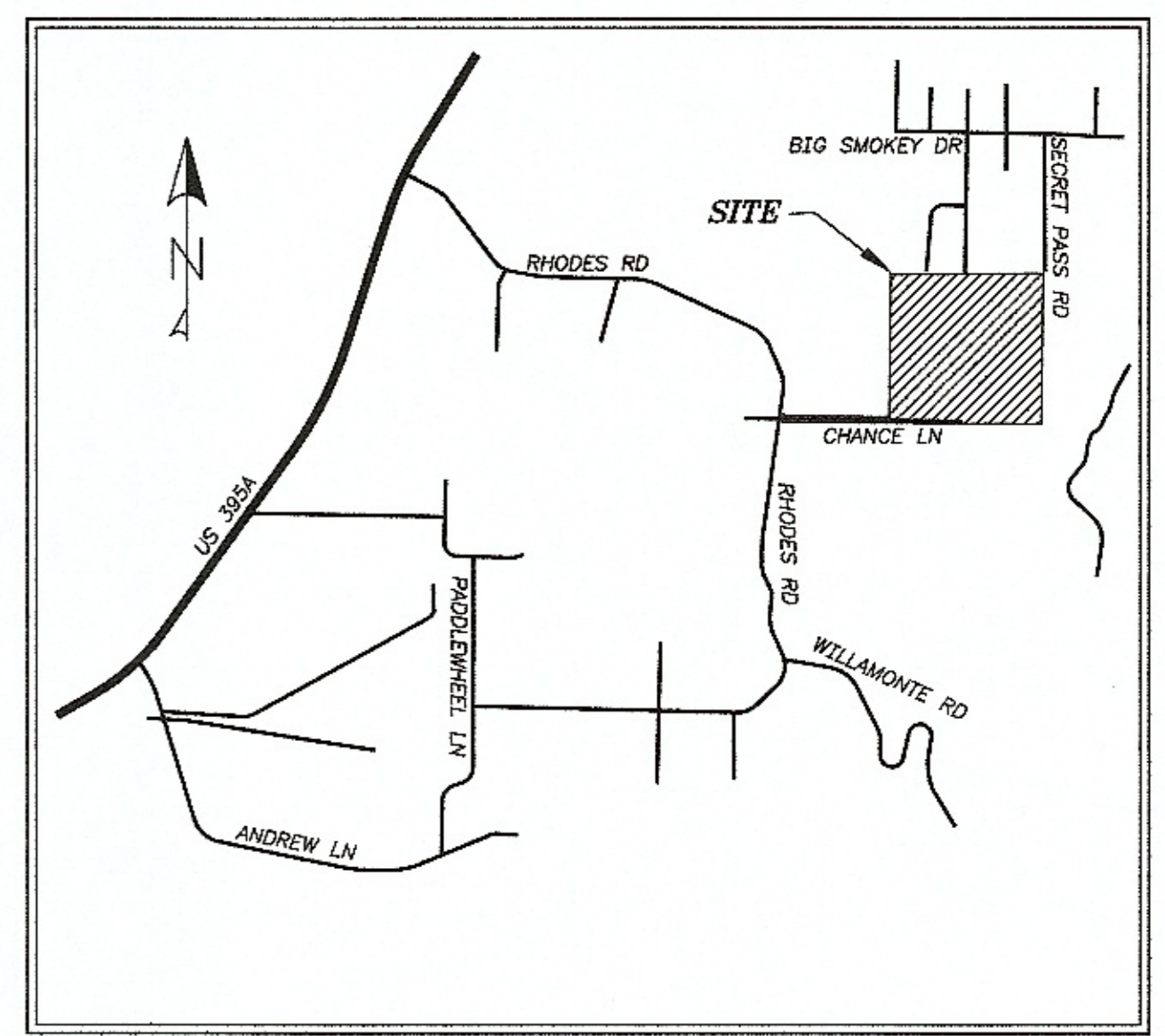
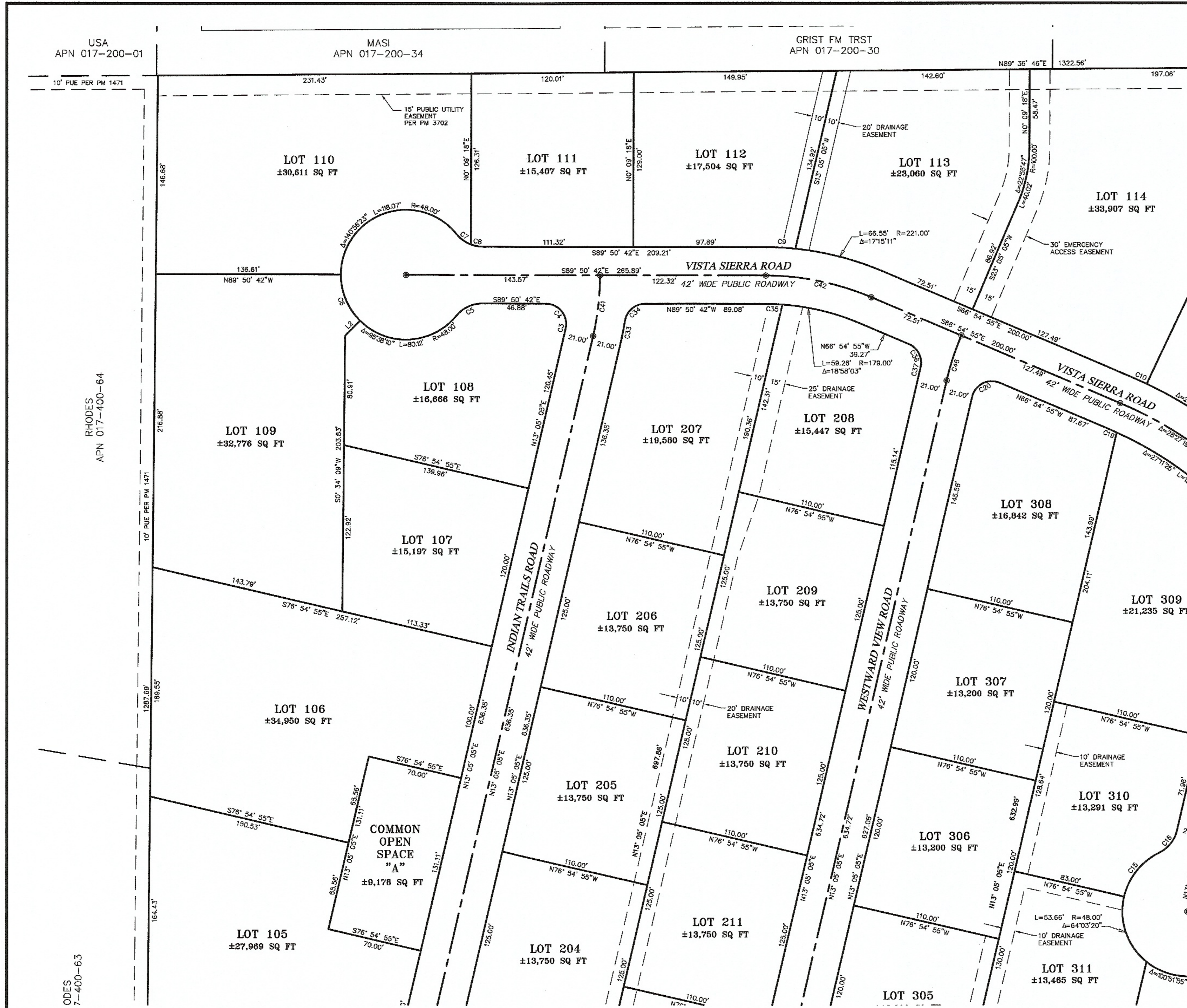

VICINITY MAP
NOT TO SCALE

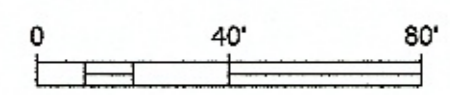
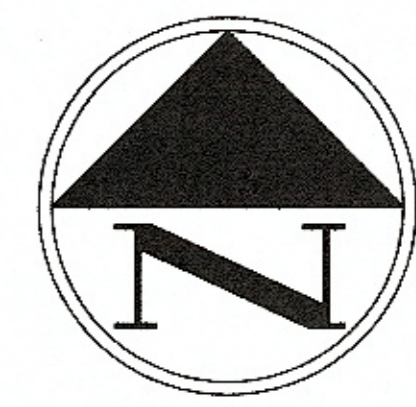

SHEET 2

BASIS OF BEARINGS
THE BASIS OF BEARINGS FOR THIS PLAT IS PARCEL MAP NO. 3702, RECORDED AS FILE NO. 2490864, OFFICIAL RECORDS OF WASHOE COUNTY.

- LEGEND**
- SET CENTERLINE MONUMENT
 - ⊥ SET 5/8" REBAR & CAP PLS 9102 OR CURB SCRIBE
 - P.U.E. PUBLIC UTILITY EASEMENT
 - D.E. DRAINAGE EASEMENT



TOTAL AREA: ±39.33 ACRES
LOT AREA: ±28.35 ACRES
ROADWAY AREA: ±4.78 ACRES
COMMON OPEN SPACE AREA: ±6.21 ACRES

SHEET 3

**TENTATIVE MAP OF
PLEASANT VALLEY ESTATES**

A SUBDIVISION OF PARCEL A & PARCEL B OF PARCEL MAP NO. 3702
SITUATE WITHIN THE N 1/2 OF SECTION 3, T17N, R20E, M.D.M.
WASHOE COUNTY NEVADA

Gray & Associates INC.
CIVIL ENGINEERS • PLANNERS • SURVEYORS
130 Vine Street Reno, Nevada 89603
(775) 329-2911 • (775) 329-6469 Fax • admin@grayassociates.net

SHEET
1
OF
5

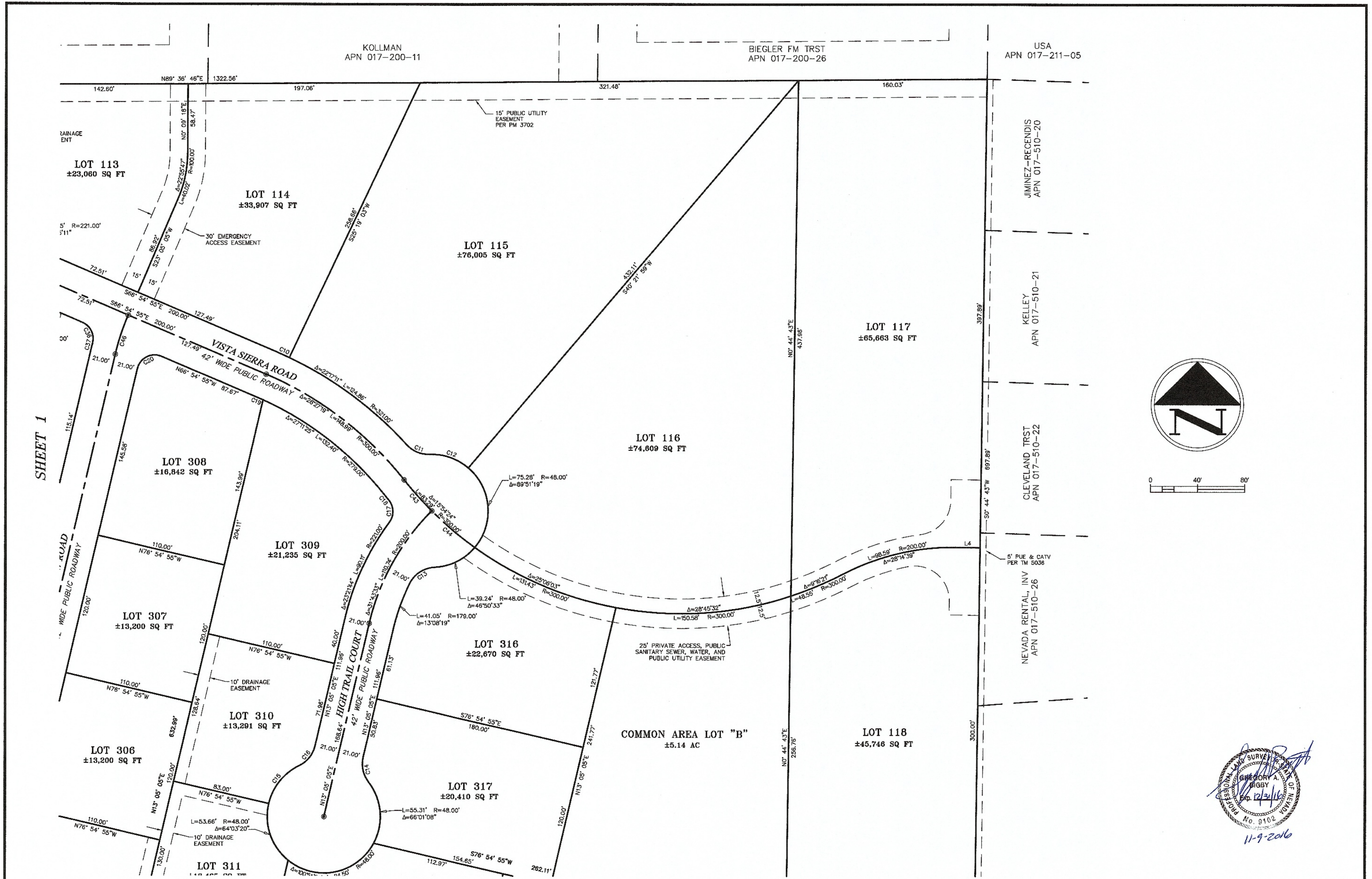

SHEET 1

SHEET 4

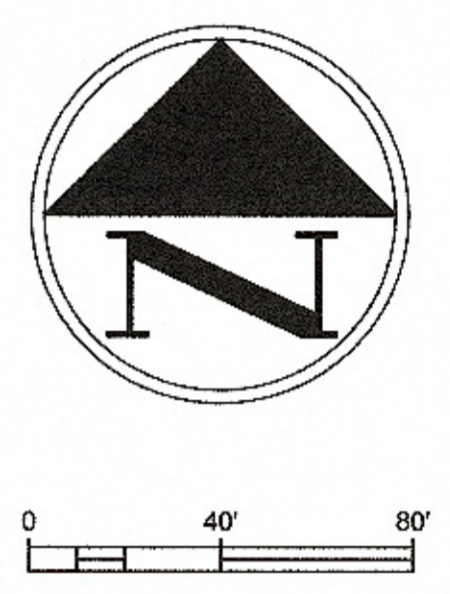

PROFESSIONAL LAND SURVEYOR
 GREGORY A. GIBBY
 No. 9102
 11-9-2016

**TENTATIVE MAP OF
 PLEASANT VALLEY ESTATES**

A SUBDIVISION OF PARCEL A & PARCEL B OF PARCEL MAP NO. 3702
 SITUATE WITHIN THE N 1/2 OF SECTION 3, T17N, R20E, M.D.M.

WASHOE COUNTY NEVADA

Gray & Associates INC. <small>CIVIL ENGINEERS • PLANNERS • SURVEYORS</small> <small>130 Vine Street Reno, Nevada 89503</small> <small>(775) 329-2911 • (775) 329-8469 Fax • admin@grayassociates.net</small>	SHEET 2 OF 5
--	-------------------------------------

SHEET 1

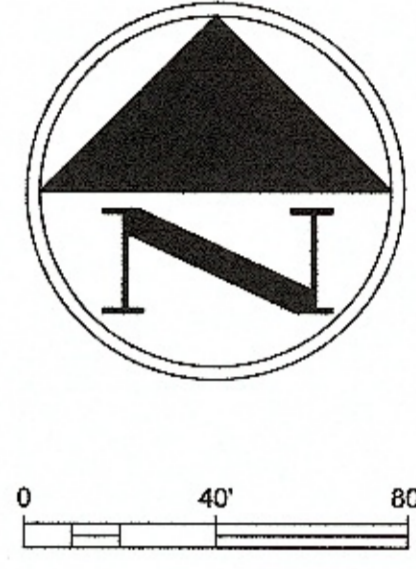
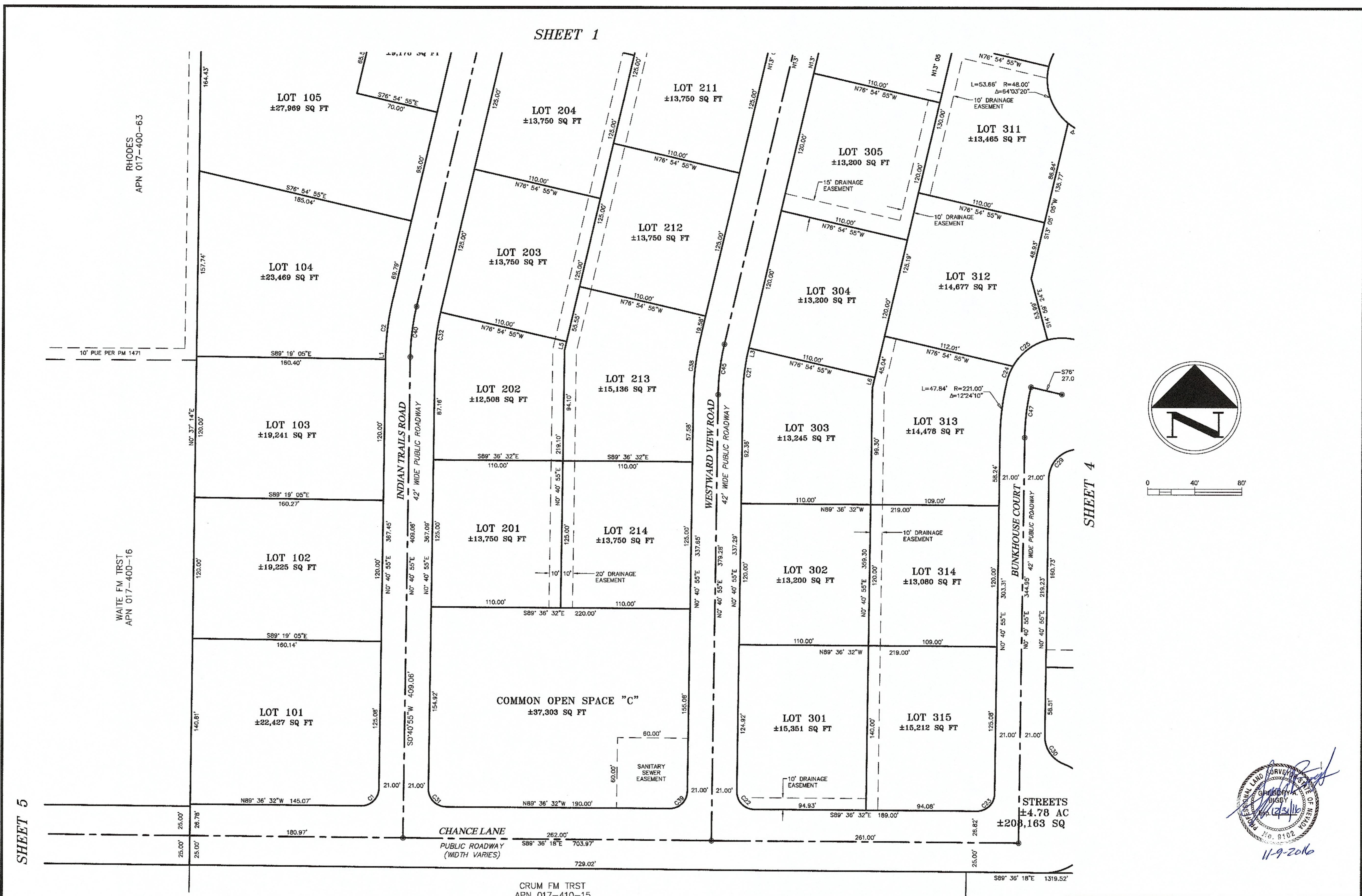

11-9-2016

SHEET 5

SHEET 4

**TENTATIVE MAP OF
PLEASANT VALLEY ESTATES**

A SUBDIVISION OF PARCEL A & PARCEL B OF PARCEL MAP NO. 3702
SITUATE WITHIN THE N 1/2 OF SECTION 3, T17N, R20E, M.D.M.

WASHOE COUNTY NEVADA

Gray & Associates INC
CIVIL ENGINEERS • PLANNERS • SURVEYORS
130 Vine Street Reno, Nevada 89508
(775) 329-2911 • (775) 329-6469 Fax • admin@grayassociates.net

SHEET
3
OF
5

SHEET 2

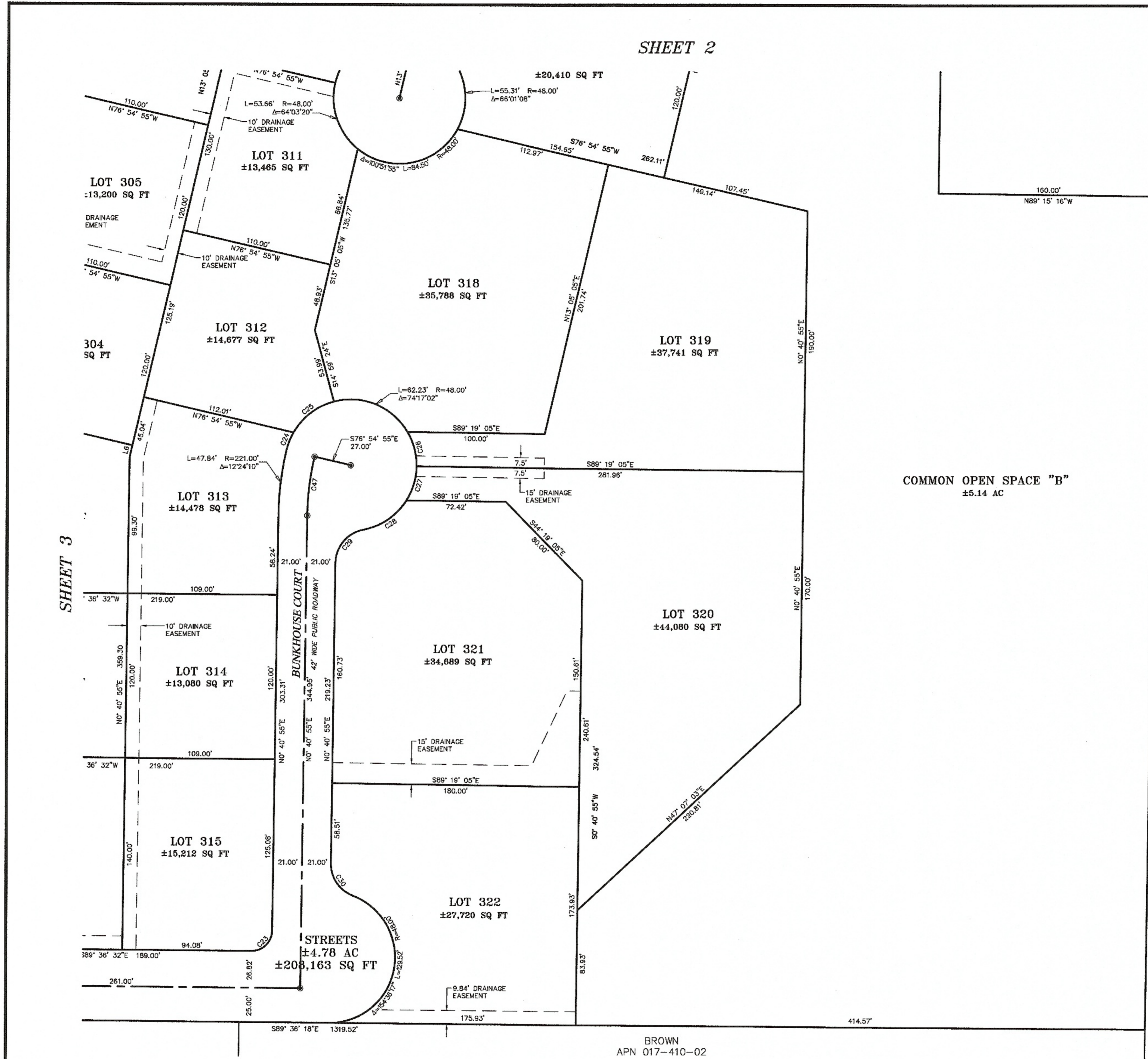

COMMON OPEN SPACE "B"
±5.14 AC

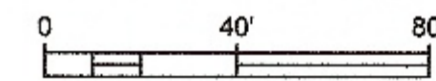

FRY
APN 017-510-38



BROWN
APN 017-410-02

TENTATIVE MAP OF
PLEASANT VALLEY ESTATES

A SUBDIVISION OF PARCEL A & PARCEL B OF PARCEL MAP NO. 3702
SITUATE WITHIN THE N 1/2 OF SECTION 3, T17N, R20E, M.D.M.

WASHOE COUNTY

NEVADA

g&a Gray & Associates INC
CIVIL ENGINEERS • PLANNERS • SURVEYORS
130 Vine Street Reno, Nevada 89503
(775) 329-2911 • (775) 329-6489 Fax • admin@grayassociates.net

SHEET
4
OF
5

CURVE TABLE			
Curve #	Delta	Radius	Length
C1	89°42'33"	15.00'	23.49'
C2	12°24'10"	221.00'	47.84'
C3	01°4'58"	179.00'	0.78'
C4	102°40'49"	15.00'	26.88'
C5	50°56'23"	25.00'	22.23'
C6	45°18'13"	48.00'	37.95'
C7	30°36'56"	25.00'	13.36'
C8	20°19'27"	25.00'	8.87'
C9	5°40'36"	221.00'	21.90'
C10	2°13'58"	321.00'	12.51'
C11	49°51'41"	25.00'	21.76'
C12	42°37'26"	48.00'	35.71'
C13	60°50'27"	25.00'	26.55'
C14	50°56'23"	25.00'	22.23'
C15	50°56'23"	48.00'	42.68'
C16	50°56'23"	25.00'	22.23'
C17	75°54'58"	15.00'	19.87'
C18	1°00'34"	321.00'	5.65'
C19	1°15'54"	279.00'	6.16'
C20	100°00'00"	15.00'	26.18'

CURVE TABLE			
Curve #	Delta	Radius	Length
C21	12°24'10"	179.00'	38.75'
C22	90°17'27"	15.00'	23.64'
C23	89°42'33"	15.00'	23.49'
C24	16°37'18"	48.00'	13.92'
C25	45°18'13"	48.00'	37.95'
C26	31°23'17"	48.00'	26.30'
C27	31°23'17"	48.00'	26.30'
C28	46°47'03"	48.00'	39.19'
C29	78°10'21"	25.00'	34.11'
C30	69°46'09"	25.00'	30.44'
C31	90°17'27"	15.00'	23.64'
C32	12°24'10"	179.00'	38.75'
C33	4°09'19"	221.00'	16.03'
C34	81°13'33"	15.00'	21.26'
C35	3°57'44"	179.00'	12.38'
C36	81°13'33"	15.00'	21.26'
C37	1°13'33"	221.00'	4.73'
C38	12°24'10"	221.00'	47.84'
C39	89°42'33"	15.00'	23.49'
C40	12°24'10"	200.00'	43.29'

CURVE TABLE			
Curve #	Delta	Radius	Length
C41	12°55'47"	200.00'	45.13'
C42	22°55'47"	200.00'	80.04'
C43	6°43'47"	300.00'	35.24'
C44	9°10'38"	300.00'	48.05'
C45	12°24'10"	200.00'	43.29'
C46	10°00'00"	200.00'	34.91'
C47	12°24'10"	200.00'	43.29'

LINE TABLE		
Line #	Direction	Length
L1	N0° 40' 55"E	2.37'
L2	N44° 51' 05"E	15.63'
L3	N13° 05' 05"E	1.50'
L4	S89° 15' 17"E	20.91'
L5	N13° 05' 05"E	7.50'
L6	N13° 05' 05"E	9.00'

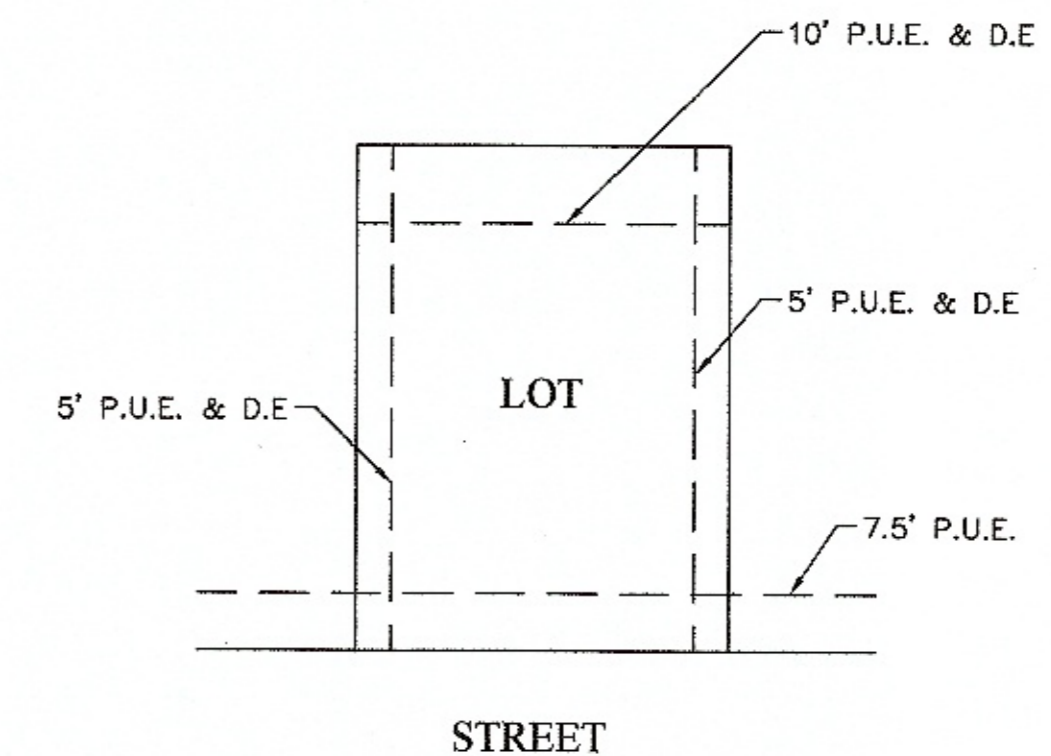
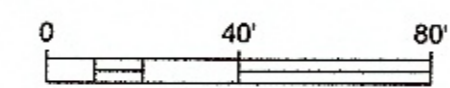
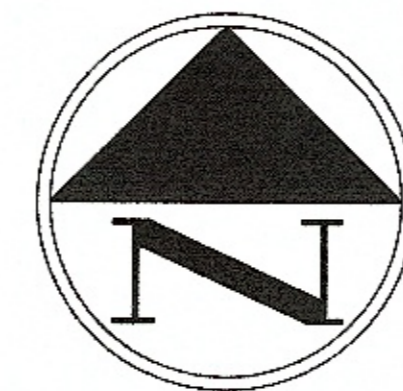

TYPICAL LOT DETAIL
NOT TO SCALE

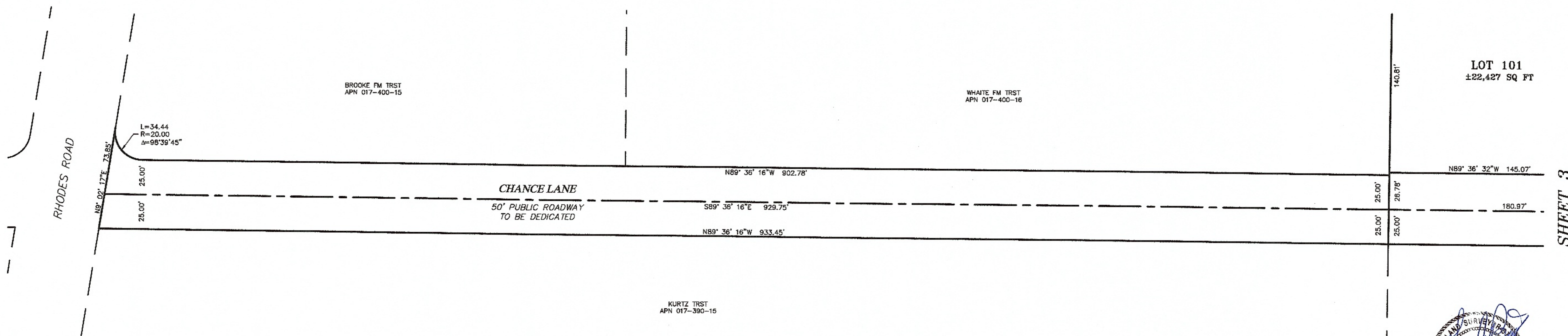

Professional Surveyor Seal for Gray & Associates, Inc., State of Nevada, License No. 9102. Handwritten signature and date 11-9-2016.

**TENTATIVE MAP OF
PLEASANT VALLEY ESTATES**

A SUBDIVISION OF PARCEL A & PARCEL B OF PARCEL MAP NO. 3702
SITUATE WITHIN THE N 1/2 OF SECTION 3, T17N, R20E, M.D.M.

WASHOE COUNTY NEVADA

Gray & Associates INC.
CIVIL ENGINEERS • PLANNERS • SURVEYORS
130 Vine Street Reno, Nevada 89503
(775) 329-8911 • (775) 329-6469 Fax • admin@grayassociates.net

SHEET

5

5

PARCEL	AREA	AREA
DETENTION POND 1	0.86 AC	37,303 SQ. FT.
OPEN SPACE 1	0.21 AC	9,178 SQ. FT.
OPEN SPACE 2	5.14 AC	223,893 SQ. FT.
PARCEL 101	0.51 AC	22,427 SQ. FT.
PARCEL 102	0.44 AC	19,225 SQ. FT.
PARCEL 103	0.44 AC	19,241 SQ. FT.
PARCEL 104	0.54 AC	23,469 SQ. FT.
PARCEL 105	0.64 AC	27,969 SQ. FT.
PARCEL 106	0.80 AC	34,950 SQ. FT.
PARCEL 107	0.35 AC	15,197 SQ. FT.
PARCEL 108	0.38 AC	16,666 SQ. FT.
PARCEL 109	0.75 AC	32,776 SQ. FT.
PARCEL 110	0.70 AC	30,611 SQ. FT.
PARCEL 111	0.35 AC	15,407 SQ. FT.
PARCEL 112	0.40 AC	17,504 SQ. FT.
PARCEL 113	0.53 AC	23,060 SQ. FT.
PARCEL 114	0.78 AC	33,907 SQ. FT.
PARCEL 115	1.74 AC	76,005 SQ. FT.
PARCEL 116	1.71 AC	74,805 SQ. FT.
PARCEL 117	1.51 AC	65,663 SQ. FT.

PARCEL	AREA	AREA
PARCEL 118	1.05 AC	45,746 SQ. FT.
PARCEL 201	0.32 AC	13,750 SQ. FT.
PARCEL 202	0.29 AC	12,508 SQ. FT.
PARCEL 203	0.32 AC	13,750 SQ. FT.
PARCEL 204	0.32 AC	13,750 SQ. FT.
PARCEL 205	0.32 AC	13,750 SQ. FT.
PARCEL 206	0.32 AC	13,750 SQ. FT.
PARCEL 207	0.46 AC	19,580 SQ. FT.
PARCEL 208	0.35 AC	15,447 SQ. FT.
PARCEL 209	0.32 AC	13,750 SQ. FT.
PARCEL 210	0.32 AC	13,750 SQ. FT.
PARCEL 211	0.32 AC	13,750 SQ. FT.
PARCEL 212	0.32 AC	13,750 SQ. FT.
PARCEL 213	0.35 AC	15,136 SQ. FT.
PARCEL 214	0.32 AC	13,750 SQ. FT.
PARCEL 301	0.35 AC	15,351 SQ. FT.
PARCEL 302	0.30 AC	13,200 SQ. FT.
PARCEL 303	0.30 AC	13,245 SQ. FT.
PARCEL 304	0.30 AC	13,200 SQ. FT.
PARCEL 305	0.30 AC	13,200 SQ. FT.

PARCEL	AREA	AREA
PARCEL 306	0.30 AC	13,200 SQ. FT.
PARCEL 307	0.30 AC	13,200 SQ. FT.
PARCEL 308	0.39 AC	16,842 SQ. FT.
PARCEL 309	0.49 AC	21,235 SQ. FT.
PARCEL 310	0.31 AC	13,291 SQ. FT.
PARCEL 311	0.31 AC	13,465 SQ. FT.
PARCEL 312	0.34 AC	14,677 SQ. FT.
PARCEL 313	0.33 AC	14,478 SQ. FT.
PARCEL 314	0.30 AC	13,080 SQ. FT.
PARCEL 315	0.35 AC	15,212 SQ. FT.
PARCEL 316	0.52 AC	22,670 SQ. FT.
PARCEL 317	0.47 AC	20,410 SQ. FT.
PARCEL 318	0.82 AC	35,788 SQ. FT.
PARCEL 319	0.87 AC	37,741 SQ. FT.
PARCEL 320	1.01 AC	44,080 SQ. FT.
PARCEL 321	0.80 AC	34,689 SQ. FT.
PARCEL 322	0.64 AC	27,720 SQ. FT.
STREETS 1	4.78 AC	208,613 SQ. FT.

Curve #	Delta	Radius	Length
C1	89°42'33"	15.00'	23.49'
C2	122°41'00"	221.00'	47.84'
C3	0°14'58"	179.00'	0.78'
C4	102°40'49"	15.00'	26.88'
C5	50°56'23"	25.00'	22.23'
C6	45°18'13"	48.00'	37.95'
C7	30°36'56"	25.00'	13.36'
C8	20°19'27"	25.00'	8.87'
C9	5°40'36"	221.00'	21.90'
C10	21°35'58"	321.00'	12.51'
C11	49°51'41"	25.00'	21.76'
C12	42°37'28"	48.00'	35.71'
C13	80°50'27"	25.00'	26.55'
C14	42°37'28"	25.00'	22.23'
C15	50°56'23"	48.00'	42.68'
C16	50°56'23"	25.00'	22.23'
C17	75°54'58"	132.00'	19.87'
C18	1°00'34"	321.00'	5.65'
C19	1°15'54"	279.00'	6.16'
C20	100°00'00"	15.00'	28.18'

Curve #	Delta	Radius	Length
C21	122°41'00"	179.00'	38.75'
C22	90°17'27"	15.00'	23.64'
C23	89°42'33"	15.00'	23.49'
C24	16°37'18"	48.00'	13.92'
C25	45°18'13"	48.00'	37.95'
C26	31°23'17"	48.00'	28.30'
C27	31°23'17"	48.00'	28.30'
C28	46°47'03"	48.00'	39.19'
C29	78°10'21"	25.00'	34.11'
C30	89°46'09"	25.00'	30.44'
C31	90°17'27"	15.00'	23.64'
C32	122°41'00"	179.00'	38.75'
C33	4°09'19"	221.00'	16.03'
C34	81°13'33"	15.00'	21.26'
C35	3°57'44"	179.00'	12.38'
C36	81°13'33"	15.00'	21.26'
C37	11°33'33"	221.00'	4.73'
C38	122°41'00"	221.00'	47.84'
C39	89°42'33"	15.00'	23.49'

Line #	Direction	Length
L1	N0°40'55.50"E	2.37'
L2	N44°51'05.20"E	15.63'
L3	N1°3'05.11"E	1.50'
L4	S89°15'16.97"E	20.91'
L5	N1°3'05.11"E	7.50'
L6	N1°3'05.11"E	9.00'

**PLEASANT VALLEY ESTATES
PROJECT STATISTICS**

TOTAL AREA = 39.34 ac
 LOT AREA = 28.35 ac
 OPEN SPACE AREA = 5.95 ac
 PUBLIC STREETS AREA = 4.78 ac
 DETENTION POND AREA = 0.86 ac

RESIDENTIAL LOTS = 54
 OPEN SPACE LOTS = 2
 DETENTION POND LOT = 1

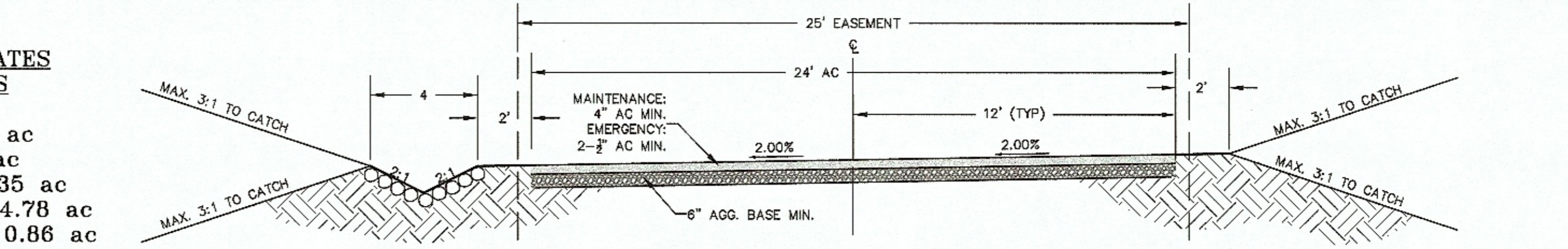
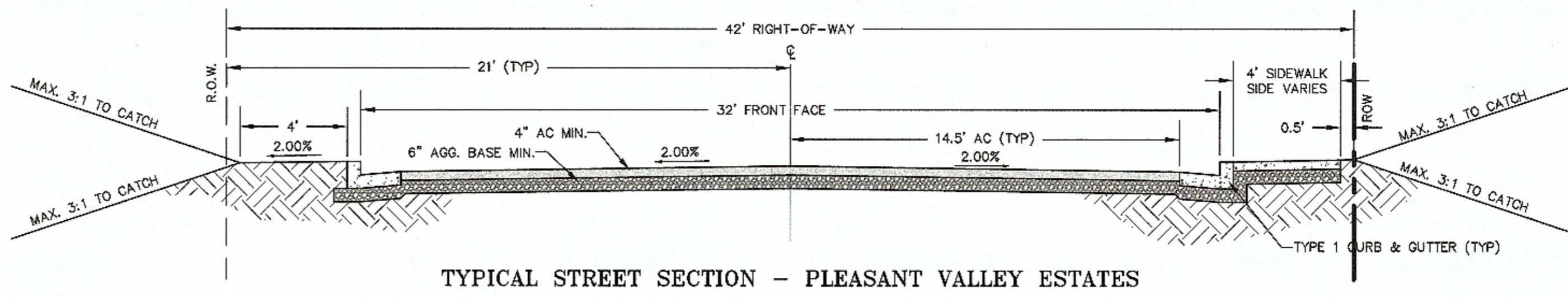

LEGEND

- (E) AC PAVEMENT TO REMAIN
- (P) AC PAVEMENT
- EXISTING
- PROPOSED
- FRONT FACE OF CURB
- ASPHALT CONCRETE
- RIGHT-OF-WAY

AREAS WITH SLOPES GREATER THAN 30%

1 inch = 40 feet

Gray & Associates, Inc.
 CIVIL ENGINEERS • PLANNERS • SURVEYORS
 1300 View Street Reno, Nevada 89503
 (775) 329-2911 • (775) 329-6669 Fax • admin@grayassociates.net

EDWARD C. THOMAS
 11-9-16
 CIVIL
 LICENSE NO. 9743
 EXP. 6/30/18

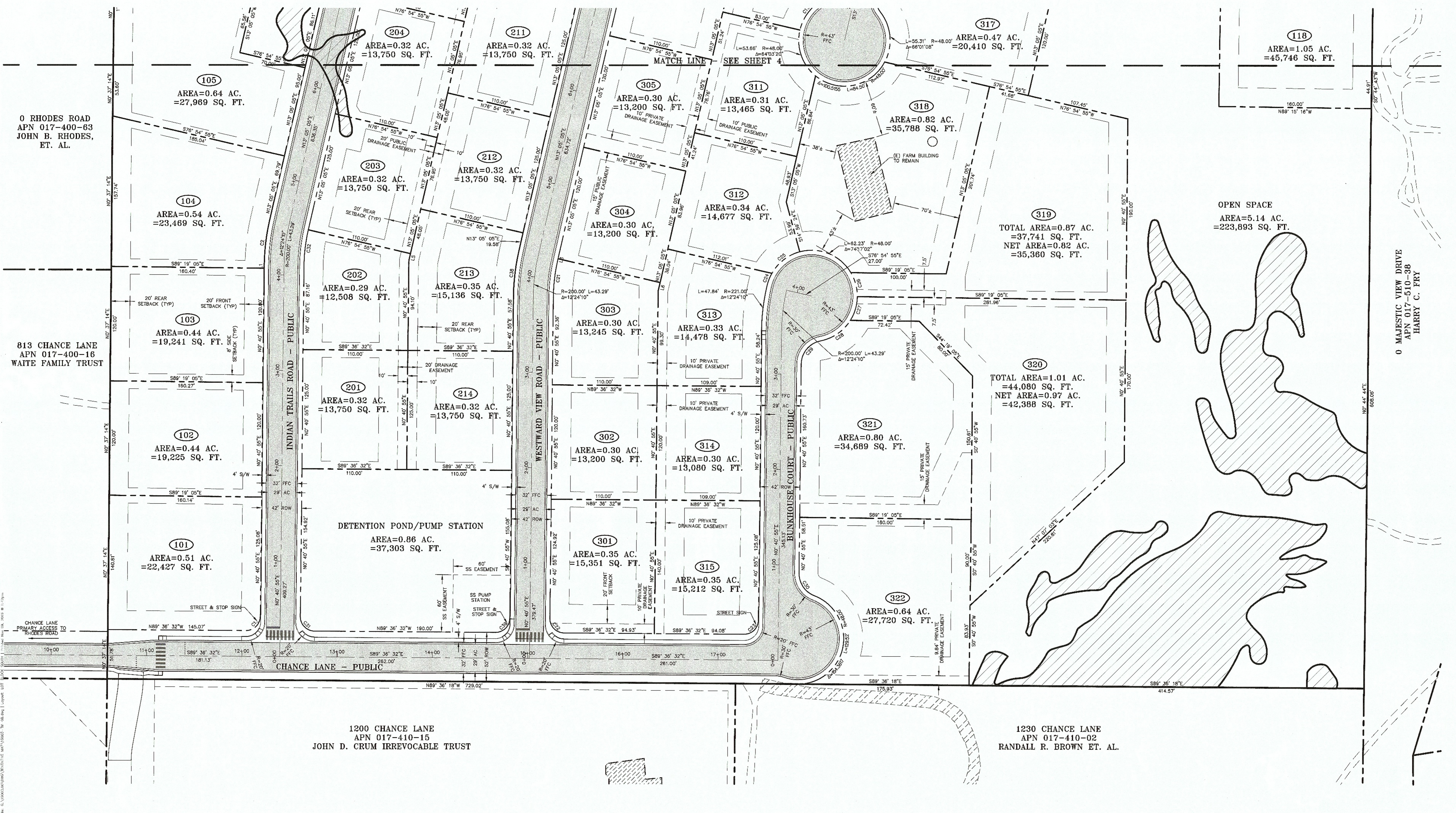

0 RHODES ROAD
 APN 017-400-63
 JOHN B. RHODES,
 ET. AL.

813 CHANCE LANE
 APN 017-400-16
 WAITE FAMILY TRUST

1200 CHANCE LANE
 APN 017-410-15
 JOHN D. CRUM IRREVOCABLE TRUST

1230 CHANCE LANE
 APN 017-410-02
 RANDALL R. BROWN ET. AL.

PLEASANT VALLEY ESTATES
 TENTATIVE MAP
 PRELIMINARY LOT & BLOCK PLAN - SOUTH
 WASHOE COUNTY - NEVADA

REVISIONS	DATE

CLIENT No.: P068
 JOB No.: 16003
 DRAWN BY: BCT
 CHECKED BY:
 DATE: 11-15-16

SHEET No.
9
 OF SEVENTEEN

PARCEL	AREA	AREA
DETENTION POND 1	0.86 AC	37303 SQ. FT.
OPEN SPACE 1	0.21 AC	9178 SQ. FT.
OPEN SPACE 2	5.14 AC	223893 SQ. FT.
PARCEL 101	0.51 AC	22427 SQ. FT.
PARCEL 102	0.44 AC	19225 SQ. FT.
PARCEL 103	0.44 AC	19241 SQ. FT.
PARCEL 104	0.54 AC	23469 SQ. FT.
PARCEL 105	0.84 AC	27969 SQ. FT.
PARCEL 106	0.80 AC	34950 SQ. FT.
PARCEL 107	0.35 AC	15197 SQ. FT.
PARCEL 108	0.38 AC	16666 SQ. FT.
PARCEL 109	0.75 AC	32776 SQ. FT.
PARCEL 110	0.70 AC	30611 SQ. FT.
PARCEL 111	0.35 AC	15407 SQ. FT.
PARCEL 112	0.40 AC	17504 SQ. FT.
PARCEL 114	0.53 AC	23060 SQ. FT.
PARCEL 115	1.74 AC	76005 SQ. FT.
PARCEL 116	1.71 AC	74609 SQ. FT.
PARCEL 117	1.51 AC	65663 SQ. FT.

PARCEL	AREA	AREA
PARCEL 118	1.05 AC	45746 SQ. FT.
PARCEL 201	0.32 AC	13750 SQ. FT.
PARCEL 202	0.29 AC	12508 SQ. FT.
PARCEL 203	0.32 AC	13750 SQ. FT.
PARCEL 204	0.32 AC	13750 SQ. FT.
PARCEL 205	0.32 AC	13750 SQ. FT.
PARCEL 206	0.32 AC	13750 SQ. FT.
PARCEL 207	0.45 AC	19580 SQ. FT.
PARCEL 208	0.35 AC	15447 SQ. FT.
PARCEL 209	0.32 AC	13750 SQ. FT.
PARCEL 210	0.32 AC	13750 SQ. FT.
PARCEL 211	0.32 AC	13750 SQ. FT.
PARCEL 212	0.32 AC	13750 SQ. FT.
PARCEL 213	0.35 AC	15136 SQ. FT.
PARCEL 214	0.32 AC	13750 SQ. FT.
PARCEL 301	0.35 AC	15351 SQ. FT.
PARCEL 302	0.30 AC	13200 SQ. FT.
PARCEL 303	0.30 AC	13245 SQ. FT.
PARCEL 304	0.30 AC	13200 SQ. FT.
PARCEL 305	0.30 AC	13200 SQ. FT.

PARCEL	AREA	AREA
PARCEL 306	0.30 AC	13200 SQ. FT.
PARCEL 307	0.30 AC	13200 SQ. FT.
PARCEL 308	0.39 AC	16842 SQ. FT.
PARCEL 309	0.49 AC	21235 SQ. FT.
PARCEL 310	0.31 AC	13291 SQ. FT.
PARCEL 311	0.31 AC	13465 SQ. FT.
PARCEL 312	0.34 AC	14677 SQ. FT.
PARCEL 313	0.33 AC	14478 SQ. FT.
PARCEL 314	0.30 AC	13080 SQ. FT.
PARCEL 315	0.35 AC	15212 SQ. FT.
PARCEL 316	0.52 AC	22870 SQ. FT.
PARCEL 317	0.47 AC	20410 SQ. FT.
PARCEL 318	0.62 AC	35788 SQ. FT.
PARCEL 319	0.87 AC	37741 SQ. FT.
PARCEL 320	1.01 AC	44089 SQ. FT.
PARCEL 321	0.80 AC	34689 SQ. FT.
PARCEL 322	0.64 AC	27720 SQ. FT.
STREETS 1	4.78 AC	208163 SQ. FT.

CURVE #	Delta	Radius	Length
C1	89°42'33"	15.00'	23.49'
C2	12°24'10"	221.00'	47.84'
C3	0°14'58"	179.00'	0.78'
C4	102°40'49"	15.00'	26.88'
C5	50°56'23"	25.00'	22.23'
C6	45°18'13"	45.00'	37.95'
C7	30°36'56"	25.00'	13.36'
C8	20°19'27"	25.00'	8.87'
C9	5°40'36"	221.00'	21.90'
C10	2°13'58"	321.00'	12.51'
C11	49°51'41"	25.00'	21.76'
C12	42°37'26"	45.00'	35.71'
C13	60°50'27"	25.00'	26.55'
C14	50°56'23"	25.00'	22.23'
C15	50°56'23"	45.00'	42.68'
C16	50°56'23"	25.00'	22.23'
C17	75°54'58"	15.00'	18.87'
C18	1°00'34"	321.00'	5.65'
C19	1°15'54"	279.00'	6.16'
C20	100°00'00"	15.00'	26.18'

CURVE #	Delta	Radius	Length
C21	12°24'10"	179.00'	38.75'
C22	90°17'27"	15.00'	23.64'
C23	89°42'33"	15.00'	23.49'
C24	16°37'18"	45.00'	13.92'
C25	45°18'13"	45.00'	37.95'
C26	31°23'17"	45.00'	26.30'
C27	31°23'17"	45.00'	26.30'
C28	46°47'03"	45.00'	38.19'
C29	78°17'21"	25.00'	34.11'
C30	69°46'09"	25.00'	30.44'
C31	90°17'27"	15.00'	23.64'
C32	12°24'10"	179.00'	38.75'
C33	4°09'19"	221.00'	16.03'
C34	81°13'33"	15.00'	21.26'
C35	37°44'44"	179.00'	12.38'
C36	81°13'33"	15.00'	21.26'
C37	1°13'33"	221.00'	4.73'
C38	12°24'10"	221.00'	47.84'
C39	89°42'33"	15.00'	23.49'

LINE #	Direction	Length
L1	N0°40'55.50"E	2.37'
L2	N44°51'05.20"E	15.63'
L3	N13°05'05.11"E	1.50'
L4	S89°15'16.97"E	20.91'
L5	N13°05'05.11"E	7.50'
L6	N13°05'05.11"E	9.00'

**PLEASANT VALLEY ESTATES
PROJECT STATISTICS**

TOTAL AREA = 39.34 ac
 LOT AREA = 28.35 ac
 OPEN SPACE AREA = 5.35 ac
 PUBLIC STREETS AREA = 4.78 ac
 DETENTION POND AREA = 0.86 ac

RESIDENTIAL LOTS = 54
 OPEN SPACE LOTS = 2
 DETENTION POND LOT = 1

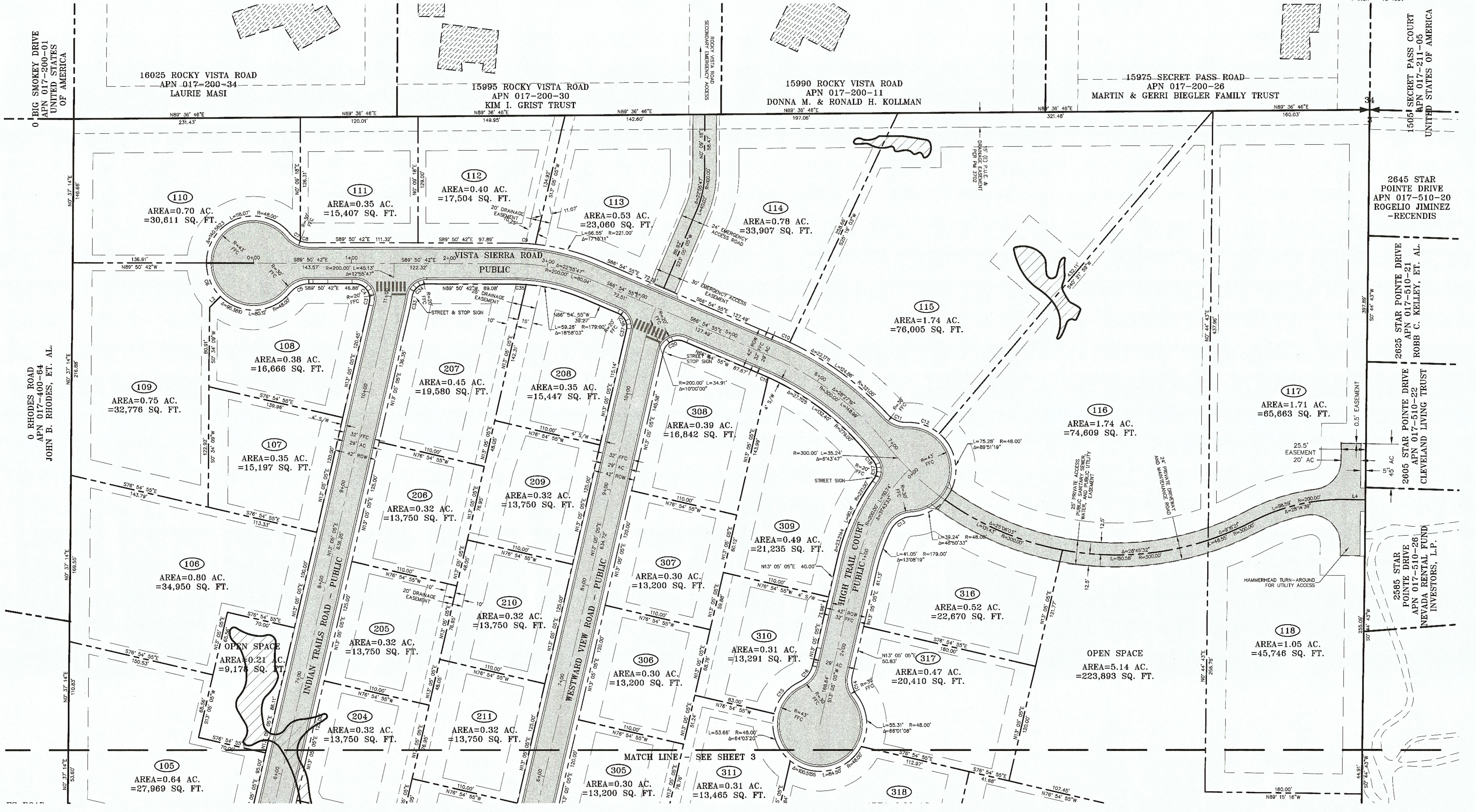
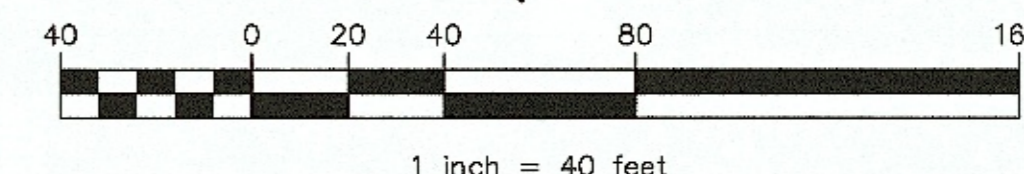
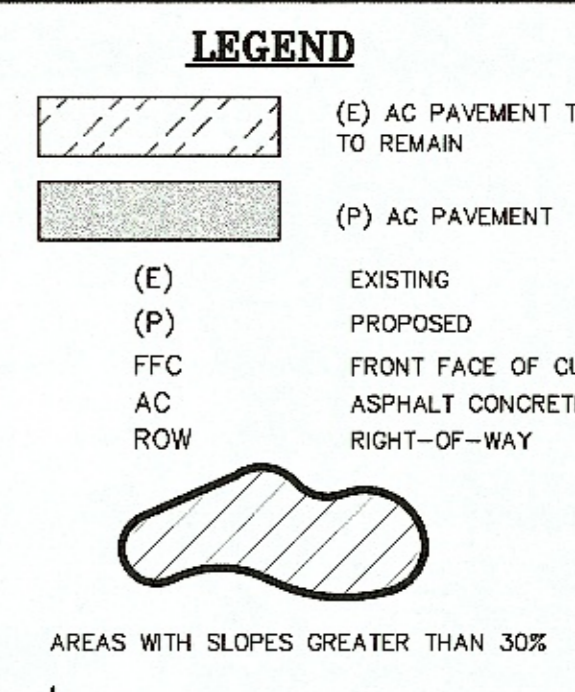
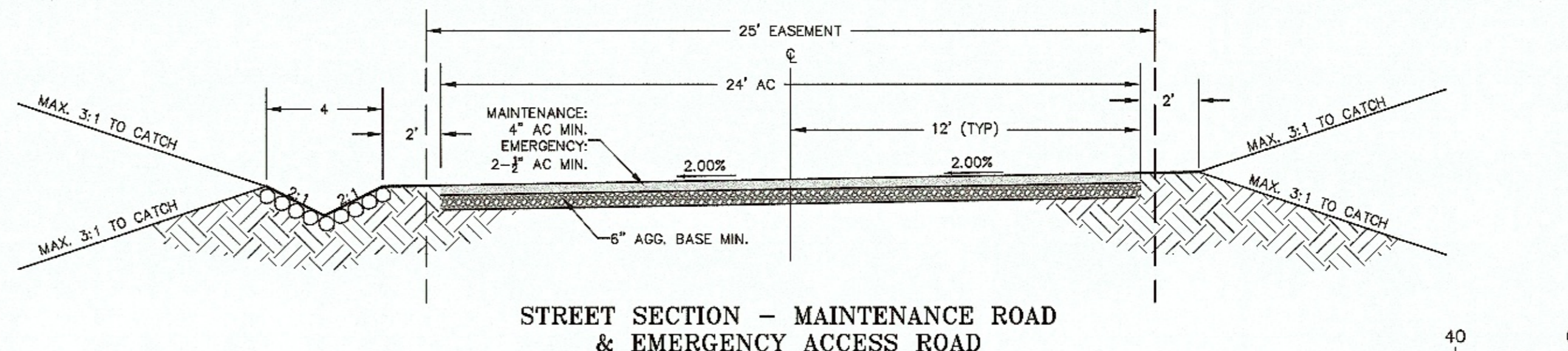
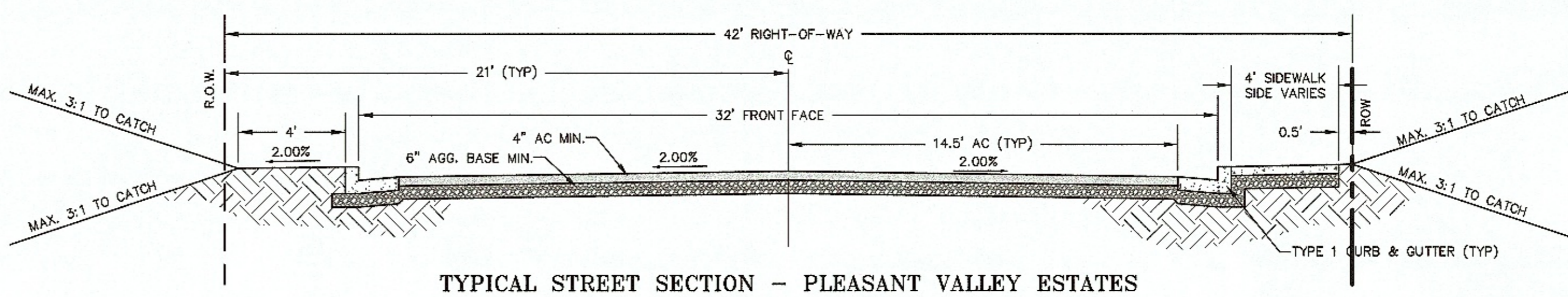

Gray & Associates, Inc.
 CIVIL ENGINEERS • PLANNERS • SURVEYORS
 130 Vine Street Reno, Nevada 89503
 (775) 329-2911 • (775) 329-6169 Fax • admin@grayassociates.com

EDWARD C. THOMAS
 1-9-16
 CIVIL ENGINEER
 No. 5740
 EXP. 6/30/18

**PLEASANT VALLEY ESTATES
TENTATIVE MAP
PRELIMINARY LOT & BLOCK PLAN - NORTH**
 WASHOE COUNTY - NEVADA

DATE	REVISIONS
CLIENT No.: P068	
JOB No.: 16003	
DRAWN BY: ECT	
CHECKED BY:	
DATE: 11-16-16	
SHEET No.	
10	
OF SEVENTEEN	

STANDARD STORM WATER POLLUTION PREVENTION NOTES:

1. THE OWNER, SITE DEVELOPER, CONTRACTOR, AND/OR THEIR AUTHORIZED AGENTS SHALL EACH DAY REMOVE ALL SEDIMENT, MUD, CONSTRUCTION DEBRIS, OR OTHER POTENTIAL POLLUTANTS THAT MAY HAVE BEEN DISCHARGED TO, OR ACCUMULATE IN, THE PUBLIC RIGHTS-OF-WAY OF WASHOE COUNTY AS A RESULT OF CONSTRUCTION ACTIVITIES ASSOCIATED WITH THIS SITE DEVELOPMENT OR CONSTRUCTION PROJECT. SUCH MATERIALS SHALL BE PREVENTED FROM ENTERING THE STORM SEWER SYSTEM.
2. ADDITIONAL CONSTRUCTION SITE DISCHARGE BEST MANAGEMENT PRACTICES MAY BE REQUIRED OF THE OWNER AND HIS OR HER AGENTS DUE TO UNFORSEEN EROSION PROBLEMS OR IF THE SUBMITTED PLAN DOES NOT MEET THE PERFORMANCE STANDARDS SPECIFIED IN WASHOE COUNTY ORDINANCE NO. 1223 AND THE TRUCKEE MEADOWS CONSTRUCTION SITE BEST MANAGEMENT PRACTICES HANDBOOK.
3. TEMPORARY OR PERMANENT STABILIZATION PRACTICES WILL BE INSTALLED ON DISTURBED AREAS AS SOON AS PRACTICABLE AND NO LATER THAN 14 DAYS AFTER THE CONSTRUCTION ACTIVITY IN THAT PORTION OF THE SITE HAS TEMPORARILY OR PERMANENTLY CEASED. SOME EXCEPTIONS MAY APPLY; REFER TO STORMWATER GENERAL PERMIT NVR100000, SECTION 1.B.1.B.(2).
4. AT A MINIMUM, THE CONTRACTOR OR HIS AGENT SHALL INSPECT ALL DISTURBED AREAS, AREAS USED FOR STORAGE OF MATERIALS, AND EQUIPMENT THAT ARE EXPOSED TO PRECIPITATION, VEHICLE ENTRANCE AND EXIT LOCATIONS AND ALL BMP'S WEEKLY, PRIOR TO A FORECASTED RAIN EVENT AND WITHIN 24 HOURS AFTER ANY ACTUAL RAIN EVENT. THE CONTRACTOR OR HIS AGENT SHALL UPDATE OR MODIFY THE STORMWATER POLLUTION PREVENTION PLAN AS NECESSARY. SOME EXCEPTIONS TO WEEKLY INSPECTIONS MAY APPLY, SUCH AS FROZEN GROUND CONDITIONS OR SUSPENSION OF LAND DISTURBANCE ACTIVITIES. REFER TO STORMWATER GENERAL PERMIT NVR100000, SECTION 1.B.1.g.
5. ACCUMULATED SEDIMENT IN BMP'S SHALL BE REMOVED WITHIN SEVEN DAYS AFTER A STORMWATER RUNOFF EVENT OR PRIOR TO THE NEXT ANTICIPATED STORM EVENT, WHICHEVER IS EARLIER. SEDIMENT MUST BE REMOVED WHEN BMP DESIGN CAPACITY HAS BEEN REDUCED BY 50 PERCENT OR MORE.

LEGEND

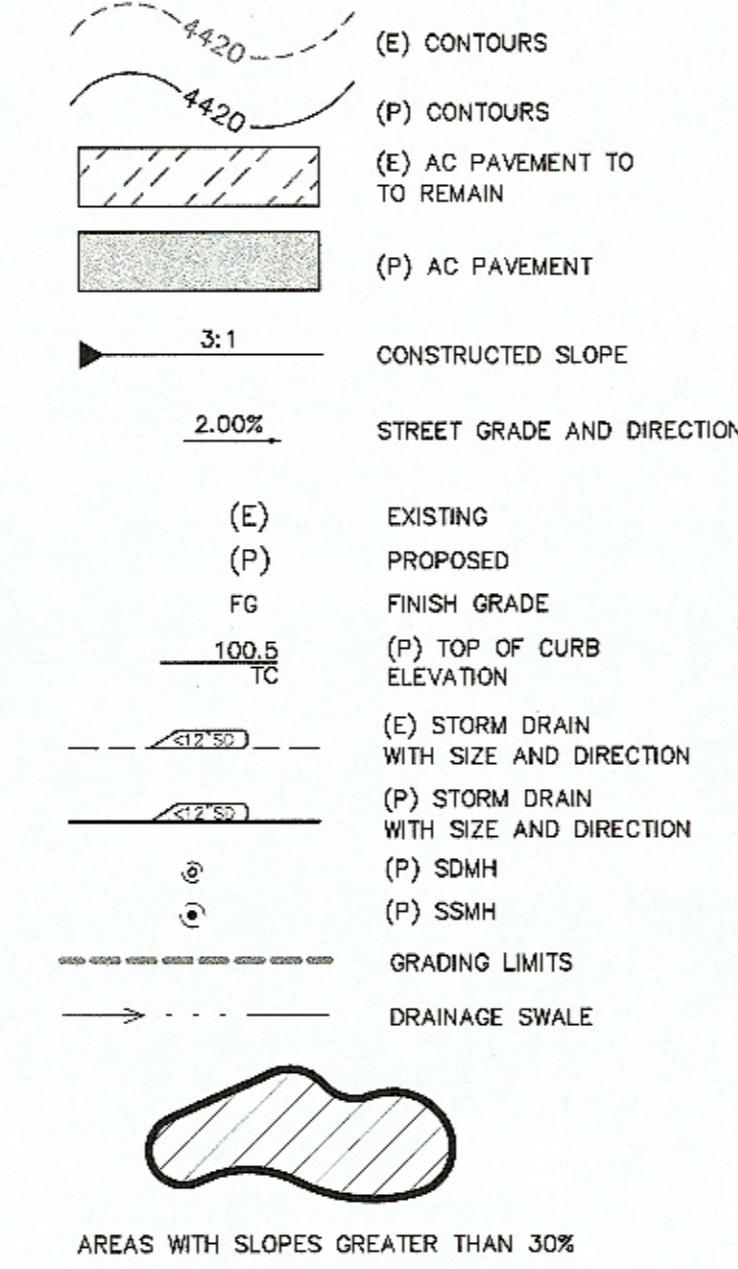

EARTHWORK SUMMARY

TOTAL AREA OF DISTURBANCE = 9.09 AC.
ON-SITE AREA OF DISTURBANCE = 7.89 AC.
OFF-SITE AREA OF DISTURBANCE (CHANCE LANE) = 1.19 AC.
AREA OF DISTURBANCE > 4.0 AC

TOTAL EARTHWORK: CUT = 14,786 CY
FILL = 11,507 CY
NET = 3,279 CY CUT

ON-SITE EARTHWORK: CUT = 9,873 CY
FILL = 10,841 CY
NET = 768 CY FILL

OFF-SITE EARTHWORK (CHANCE LANE): CUT = 4,913 CY
FILL = 866 CY
NET = 4,047 CY CUT

TOTAL VOLUME OF EXCAVATION > 5,000 CY
TOTAL VOLUME OF IMPORT > 5,000 CY

AREA OF DISTURBANCE ON SLOPES OF 15% OR STEEPER (ON SITE) = 3.01 AC.
AREA OF DISTURBANCE ON SLOPES OF 15% OR STEEPER > 2 AC.
EARTHWORK ON SLOPES OF 15% OR STEEPER: CUT = 2,850 CY
FILL = 4,745 CY
NET = 1,895 CY

TOTAL VOLUME OF EXCAVATION ON SLOPES OF 15% OR STEEPER > 1,000 CY
TOTAL VOLUME OF IMPORT ON SLOPES OF 15% OR STEEPER > 1,000 CY

NO EARTH IS PROPOSED TO BE REMOVED FROM SITE. EXCESS CUT MATERIAL CONSISTS ENTIRELY OF STRIPPINGS. STRIPPINGS WILL BE USED AS TOPSOIL IN DETENTION POND AND ON SLOPES.

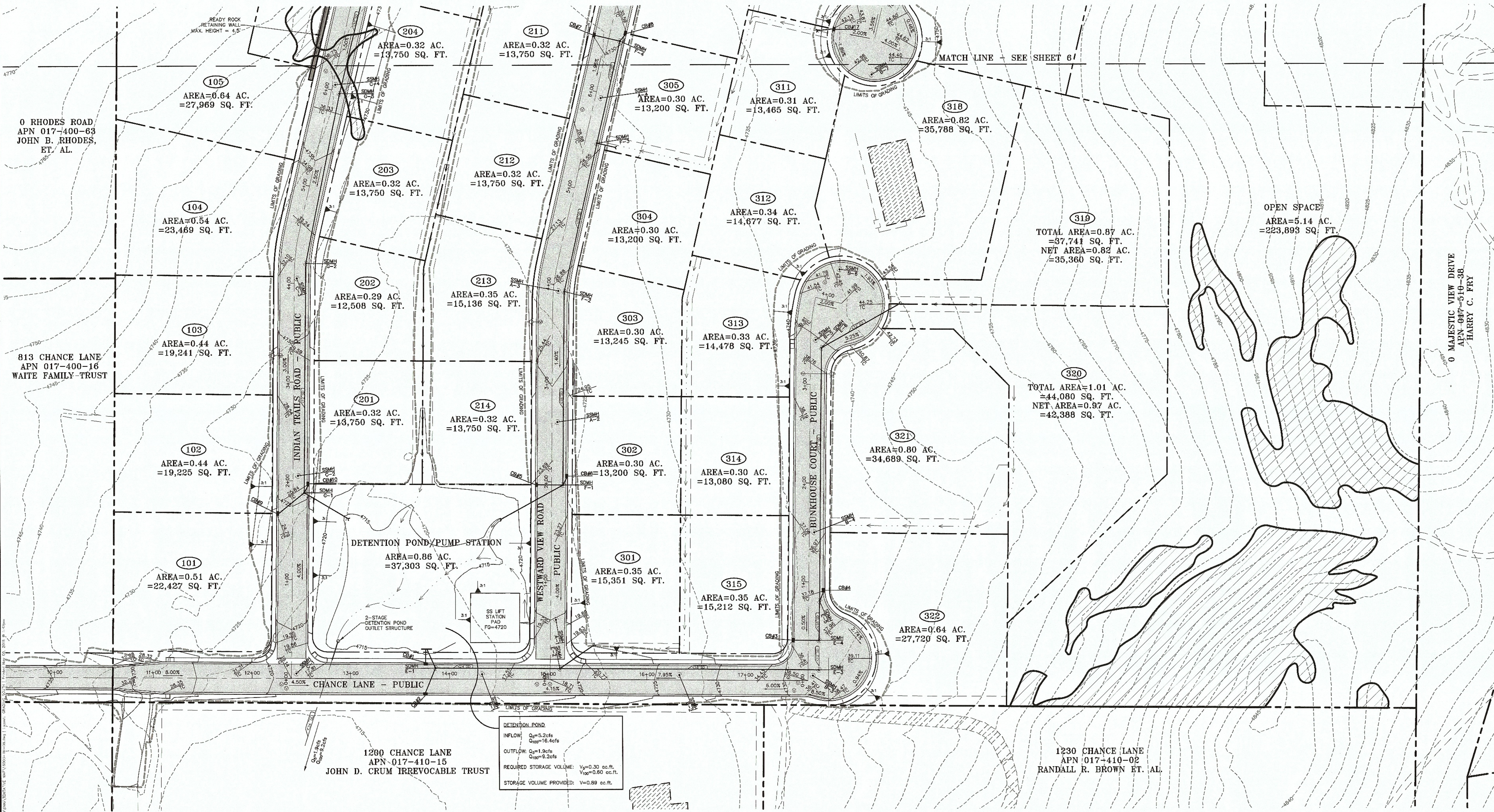
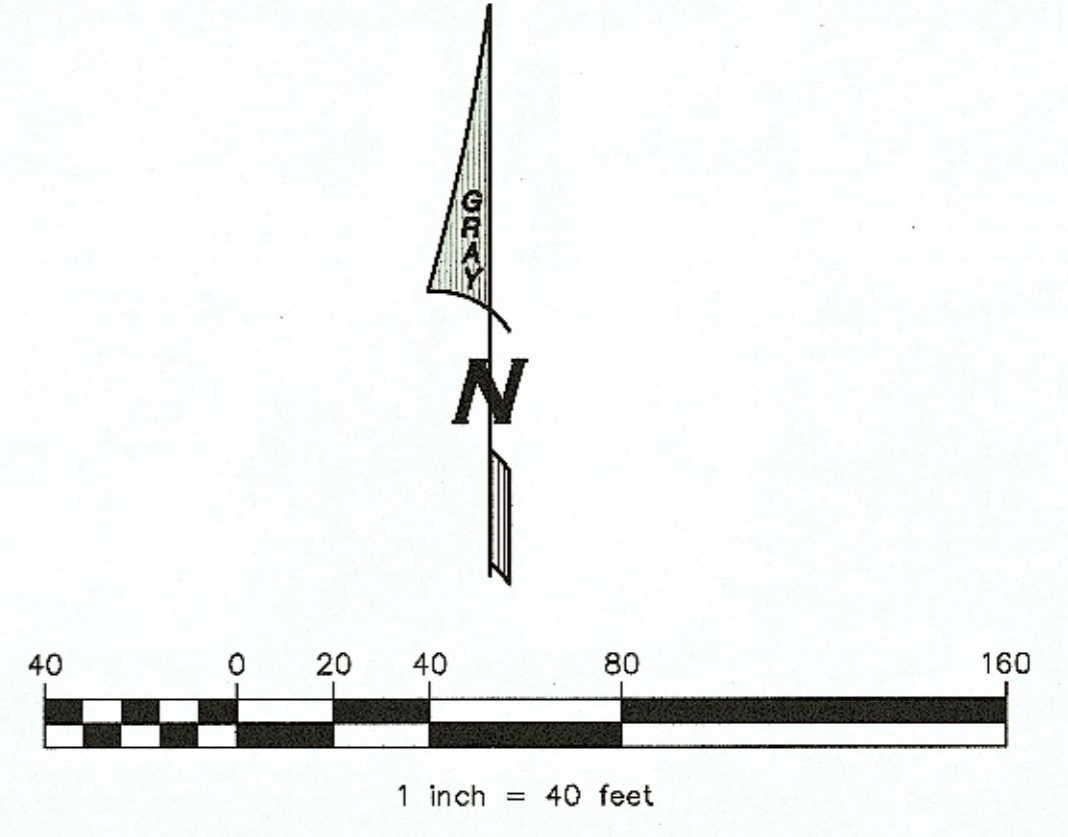

Gray & Associates, Inc.
CIVIL ENGINEERS • PLANNERS • SURVEYORS
1300 Vista Street Reno, Nevada 89503
(775) 329-2811 • (775) 329-6668 Fax • admin@grayassociates.com

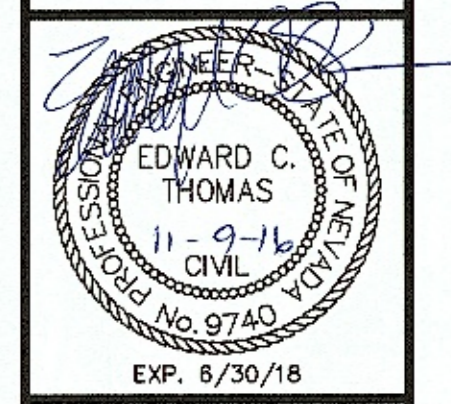

PLEASANT VALLEY ESTATES
TENTATIVE MAP
PRELIMINARY GRADING PLAN - SOUTH
WASHOE COUNTY - NEVADA

DATE	BY
REVISIONS	
CLIENT No.: P068	
JOB No.: 16003	
DRAWN BY: ECT	
CHECKED BY:	
DATE: 11-16-16	
SHEET No.	
11	
OF SEVENTEEN	

STANDARD STORM WATER POLLUTION PREVENTION NOTES:

1. THE OWNER, SITE DEVELOPER, CONTRACTOR, AND/OR THEIR AUTHORIZED AGENTS SHALL EACH DAY REMOVE ALL SEDIMENT, MUD, CONSTRUCTION DEBRIS, OR OTHER POTENTIAL POLLUTANTS THAT MAY HAVE BEEN DISCHARGED TO, OR ACCUMULATE IN, THE PUBLIC RIGHTS-OF-WAY OF WASHOE COUNTY AS A RESULT OF CONSTRUCTION ACTIVITIES ASSOCIATED WITH THIS SITE DEVELOPMENT OR CONSTRUCTION PROJECT. SUCH MATERIALS SHALL BE PREVENTED FROM ENTERING THE STORM SEWER SYSTEM.
2. ADDITIONAL CONSTRUCTION SITE DISCHARGE BEST MANAGEMENT PRACTICES MAY BE REQUIRED OF THE OWNER AND HIS OR HER AGENTS DUE TO UNFORSEEN EROSION PROBLEMS OR IF THE SUBMITTED PLAN DOES NOT MEET THE PERFORMANCE STANDARDS SPECIFIED IN WASHOE COUNTY ORDINANCE NO. 1223 AND THE TRUCKEE MEADOWS CONSTRUCTION SITE BEST MANAGEMENT PRACTICES HANDBOOK.
3. TEMPORARY OR PERMANENT STABILIZATION PRACTICES WILL BE INSTALLED ON DISTURBED AREAS AS SOON AS PRACTICABLE AND NO LATER THAN 14 DAYS AFTER THE CONSTRUCTION ACTIVITY IN THAT PORTION OF THE SITE HAS TEMPORARILY OR PERMANENTLY CEASED. SOME EXCEPTIONS MAY APPLY; REFER TO STORMWATER GENERAL PERMIT NV100000, SECTION 1.B.1.B.(2).
4. AT A MINIMUM, THE CONTRACTOR OR HIS AGENT SHALL INSPECT ALL DISTURBED AREAS, AREAS USED FOR STORAGE OF MATERIALS, AND EQUIPMENT THAT ARE EXPOSED TO PRECIPITATION, VEHICLE ENTRANCE AND EXIT LOCATIONS AND ALL BMP'S WEEKLY, PRIOR TO A FORECASTED RAIN EVENT AND WITHIN 24 HOURS AFTER ANY ACTUAL RAIN EVENT. THE CONTRACTOR OR HIS AGENT SHALL UPDATE OR MODIFY THE STORMWATER POLLUTION PREVENTION PLAN AS NECESSARY. SOME EXCEPTIONS TO WEEKLY INSPECTIONS MAY APPLY, SUCH AS FROZEN GROUND CONDITIONS OR SUSPENSION OF LAND DISTURBANCE ACTIVITIES. REFER TO STORMWATER GENERAL PERMIT NV100000, SECTION 1.B.1.G.
5. ACCUMULATED SEDIMENT IN BMP'S SHALL BE REMOVED WITHIN SEVEN DAYS AFTER A STORMWATER RUNOFF EVENT OR PRIOR TO THE NEXT ANTICIPATED STORM EVENT, WHICHEVER IS EARLIER. SEDIMENT MUST BE REMOVED WHEN BMP DESIGN CAPACITY HAS BEEN REDUCED BY 50 PERCENT OR MORE.

LEGEND

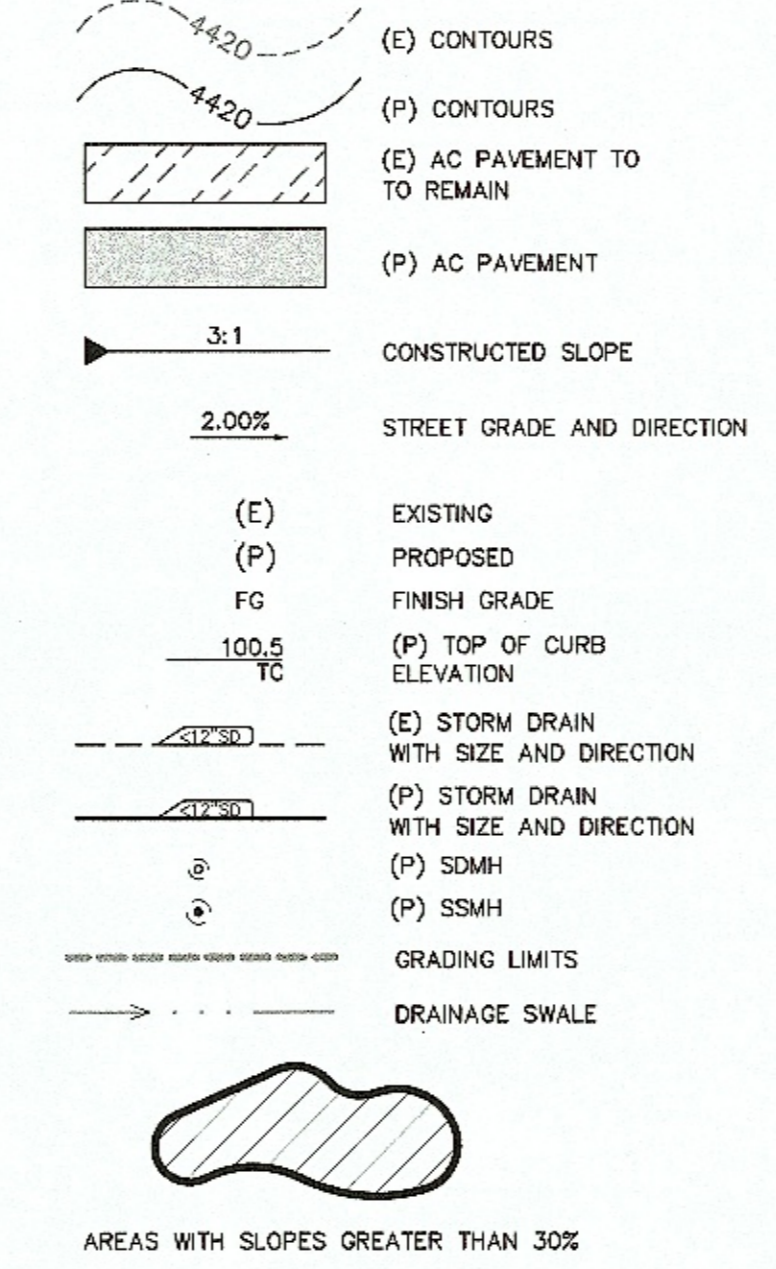

EARTHWORK SUMMARY
 TOTAL AREA OF DISTURBANCE - 9.09 AC.
 ON-SITE AREA OF DISTURBANCE - 7.80 AC.
 OFF-SITE AREA OF DISTURBANCE (CHANCE LANE) - 1.19 AC.
 AREA OF DISTURBANCE > 4.0 AC.
 TOTAL EARTHWORK: CUT = 14,786 CY
 FILL = 11,507 CY
 NET = 3,279 CY CUT
 ON-SITE EARTHWORK: CUT = 9,873 CY
 FILL = 15,841 CY
 NET = 768 CY FILL
 OFF-SITE EARTHWORK (CHANCE LANE): CUT = 4,913 CY
 FILL = 868 CY
 NET = 4,045 CY CUT
 TOTAL VOLUME OF EXCAVATION > 5,000 CY
 TOTAL VOLUME OF IMPORT > 5,000 CY
 AREA OF DISTURBANCE ON SLOPES OF 15% OR STEEPER (ON SITE) - 3.01 AC.
 AREA OF DISTURBANCE ON SLOPES OF 15% OR STEEPER > 2 AC.
 EARTHWORK ON SLOPES OF 15% OR STEEPER: CUT = 2,850 CY
 FILL = 4,745 CY
 NET = 1,895 CY
 TOTAL VOLUME OF EXCAVATION ON SLOPES OF 15% OR STEEPER > 1,000 CY
 TOTAL VOLUME OF IMPORT ON SLOPES OF 15% OR STEEPER > 1,000 CY
 NO EARTH IS PROPOSED TO BE REMOVED FROM SITE. EXCESS CUT MATERIAL CONSISTS ENTIRELY OF STRIPPINGS. STRIPPINGS WILL BE USED AS TOPSOIL IN DETENTION POND AND ON SLOPES.

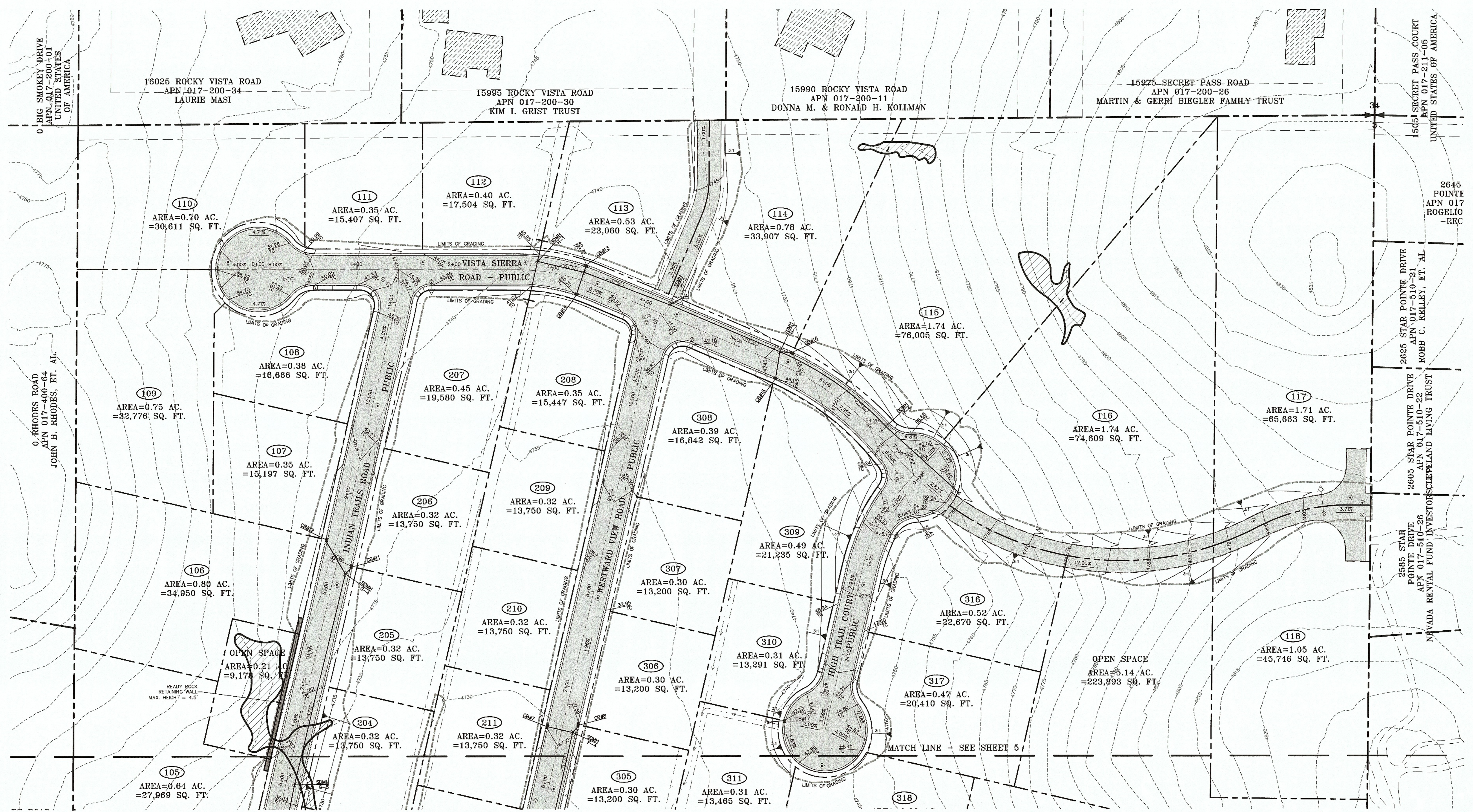
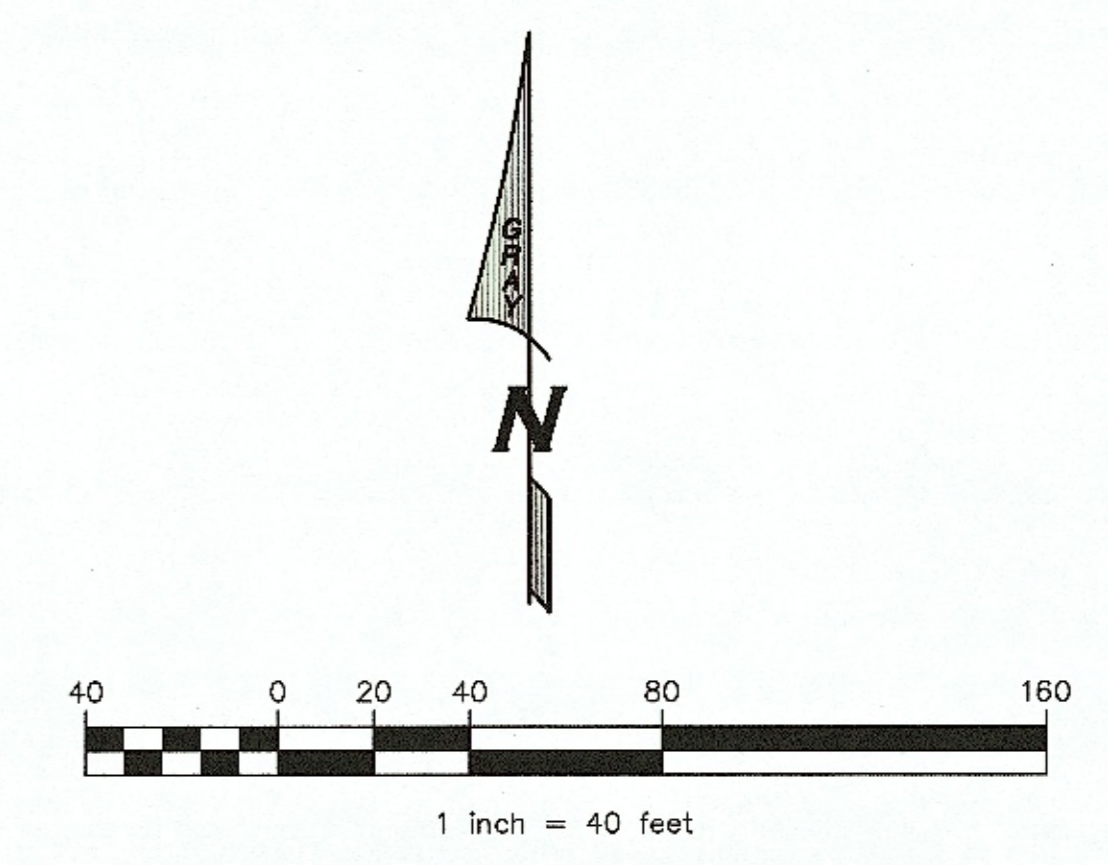

Gray & Associates, Inc.
 CIVIL ENGINEERS • PLANNERS • SURVEYORS
 130 Vine Street Reno, Nevada 89503
 (775) 329-2911 • (775) 329-6668 Fax • admin@grayassociates.com

EDWARD C. THOMAS
 CIVIL ENGINEER
 No. 9740
 Exp. 6/30/18

**PLEASANT VALLEY ESTATES
 TENTATIVE MAP
 PRELIMINARY GRADING PLAN - NORTH**
 WASHOE COUNTY - NEVADA

DATE	REVISIONS

CLIENT No.: P068
 JOB No.: 10003
 DRAWN BY: SCT
 CHECKED BY:
 DATE: 11-16-18

PLEASANT VALLEY ESTATES
 TENTATIVE MAP
 PRELIMINARY UTILITY PLAN - SOUTH
 WASHOE COUNTY - NEVADA

LEGEND

	(E) AC PAVEMENT TO REMAIN		(E) STORM DRAIN WITH SIZE AND DIRECTION
	(P) AC PAVEMENT		(E) STORM DRAIN WITH SIZE AND DIRECTION
	(P) SWALE		(P) STORM DRAIN WITH SIZE AND DIRECTION
	(E) EXISTING PROPOSED		(P) STORM DRAIN WITH SIZE AND DIRECTION
	(P) SSMH		(P) SANITARY SEWER FORCE MAIN WITH SIZE
	(P) SSMH		(E) OVERHEAD ELECTRIC
	(P) FIRE HYDRANT		(P) WATER MAIN
	(P) FIRE HYDRANT		(P) ELECTRICAL CONDUIT
	(P) SINGLE WATER SERVICE		(E) FENCE
	(P) DOUBLE WATER SERVICE		
	(P) FLUSH VALVE ASSEMBLY		

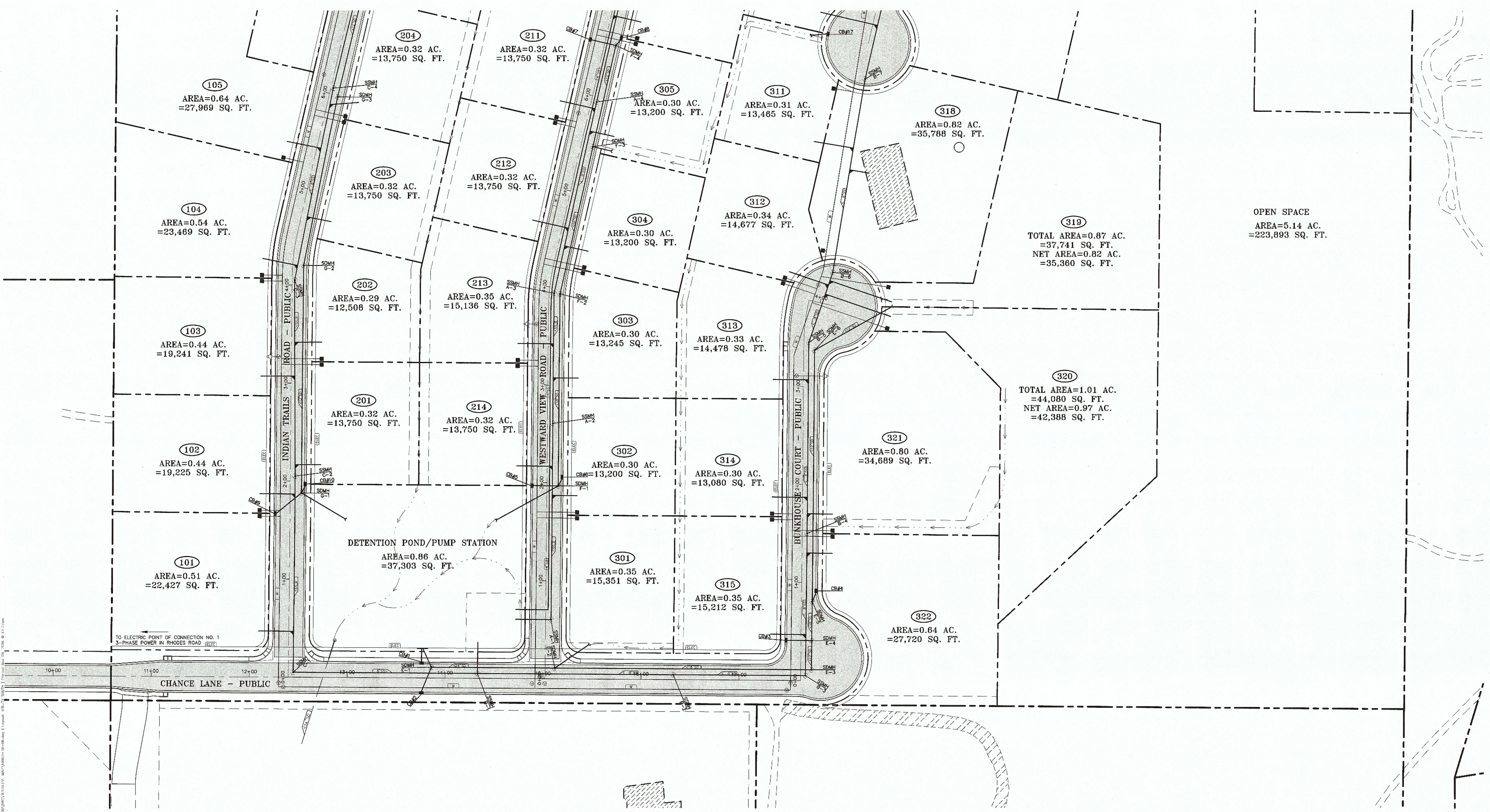
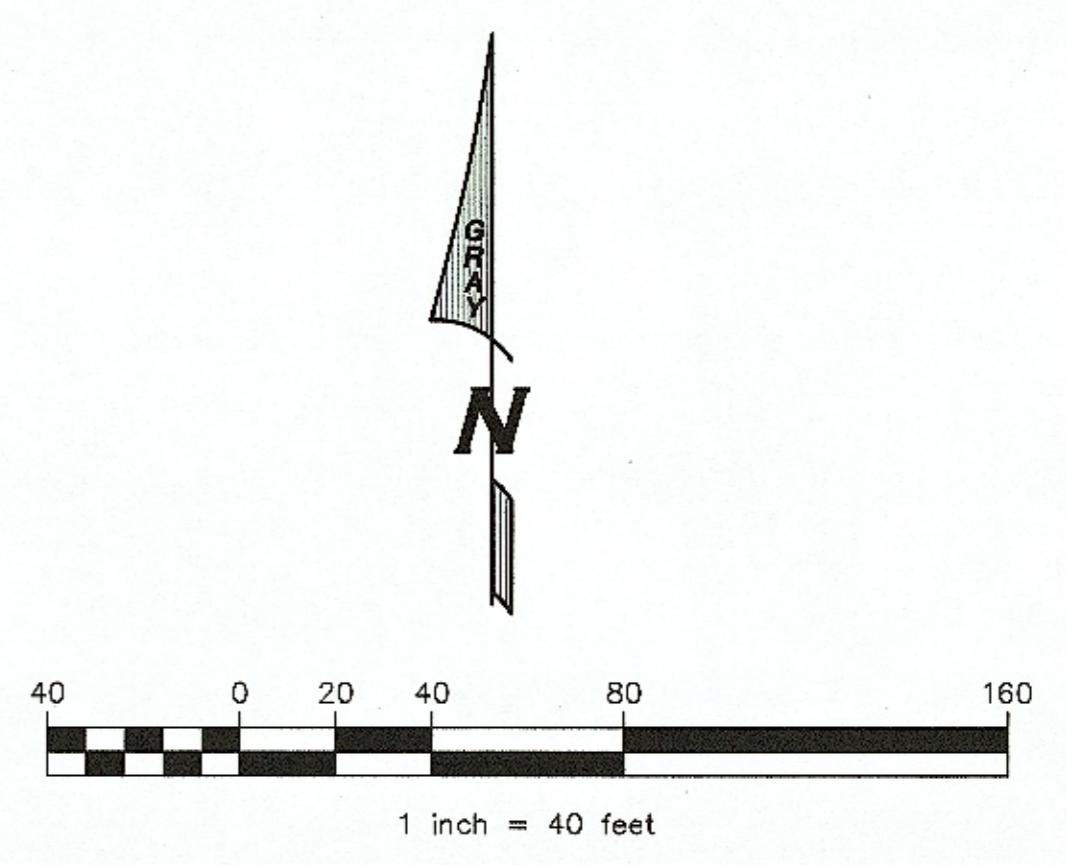

OPEN SPACE
 AREA=5.14 AC.
 =223,893 SQ. FT.

319
 TOTAL AREA=0.87 AC.
 =37,741 SQ. FT.
 NET AREA=0.82 AC.
 =35,360 SQ. FT.

320
 TOTAL AREA=1.01 AC.
 =44,080 SQ. FT.
 NET AREA=0.97 AC.
 =42,388 SQ. FT.

DATE	REVISIONS

CLIENT No.: P068
 JOB No.: 10003
 DRAWN BY: ECT
 CHECKED BY:
 DATE: 11-16-16

PLEASANT VALLEY ESTATES
 TENTATIVE MAP
 PRELIMINARY UTILITY PLAN - NORTH
 WASHOE COUNTY - NEVADA

LEGEND

	(E) AC PAVEMENT TO REMAIN		(E) STORM DRAIN WITH SIZE AND DIRECTION
	(P) AC PAVEMENT		(E) STORM DRAIN WITH SIZE AND DIRECTION
	(P) SWALE		(P) STORM DRAIN WITH SIZE AND DIRECTION
	(E) EXISTING		(P) STORM DRAIN WITH SIZE AND DIRECTION
	(P) PROPOSED		(P) SANITARY SEWER FORCE MAIN WITH SIZE
	(P) SSMH		(E) OVERHEAD ELECTRIC
	(P) SDMH		(P) WATER MAIN
	(P) FIRE HYDRANT		(P) ELECTRICAL CONDUIT
	(P) FIRE HYDRANT		(E) FENCE
	(P) SINGLE WATER SERVICE		
	(P) DOUBLE WATER SERVICE		
	(P) FLUSH VALVE ASSEMBLY		

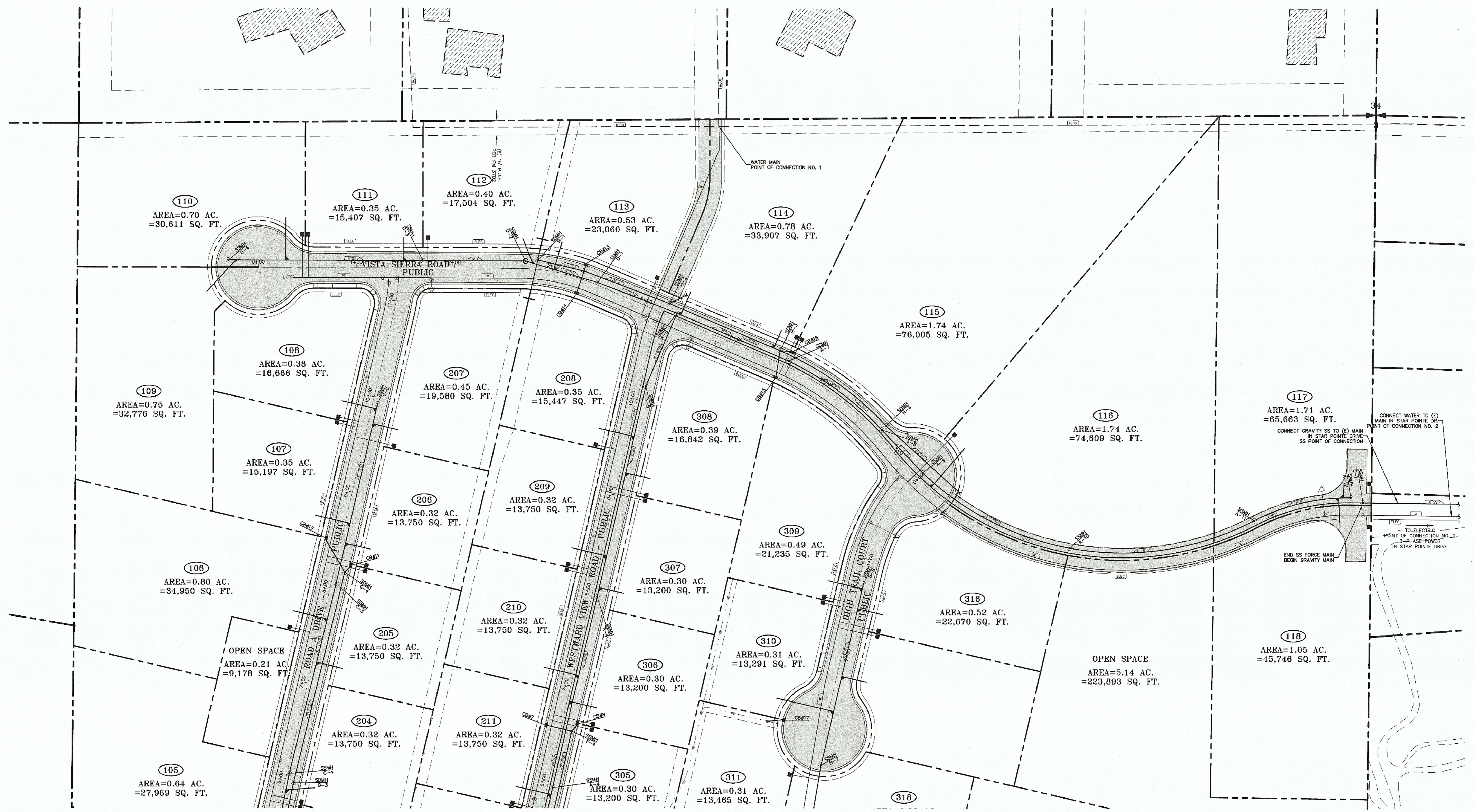
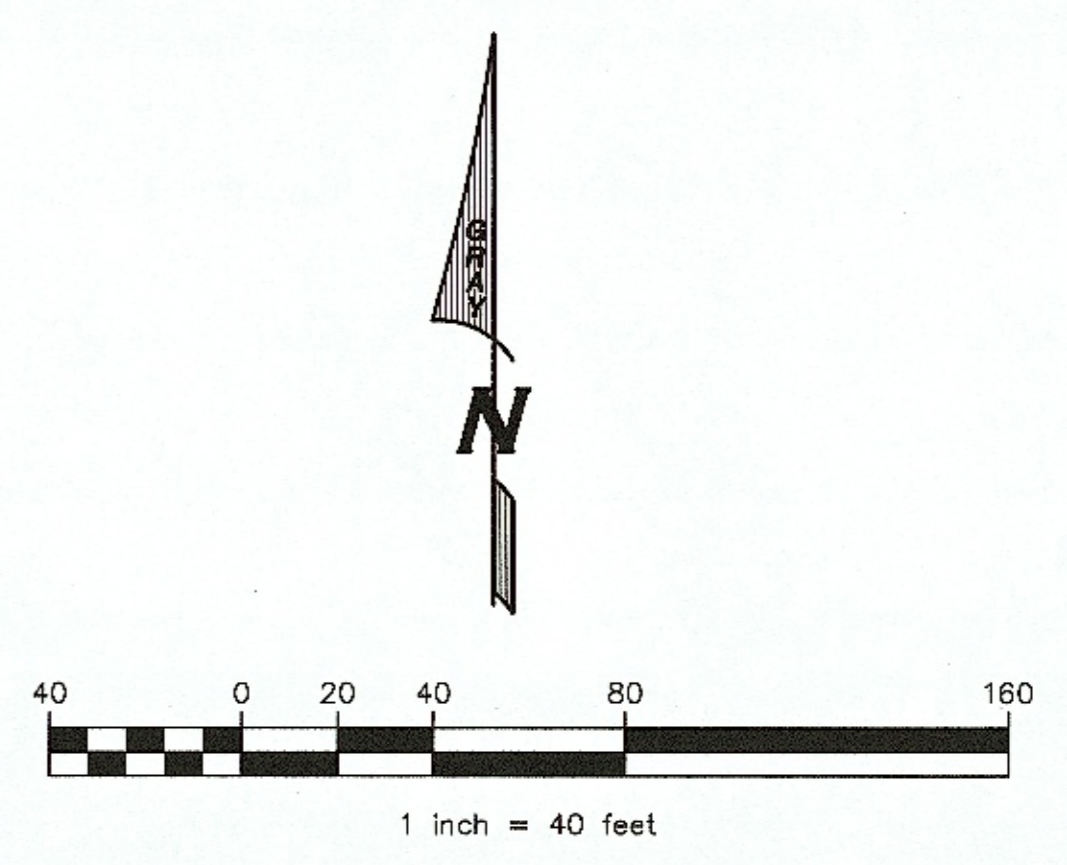

DATE	
REVISIONS	
BY	

CLIENT No.: P068
 JOB No.: 16003
 DRAWN BY: BCT
 CHECKED BY:
 DATE: 11-16-16

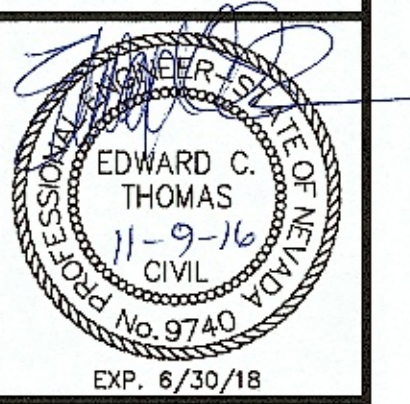

PLEASANT VALLEY ESTATES
TENTATIVE MAP
CHANCE LANE - PRIMARY ACCESS
 WASHOE COUNTY - NEVADA

DATE	REVISIONS

CLIENT No.: P068
 JOB No.: 10003
 DRAWN BY: ECT
 CHECKED BY:
 DATE: 11-15-18

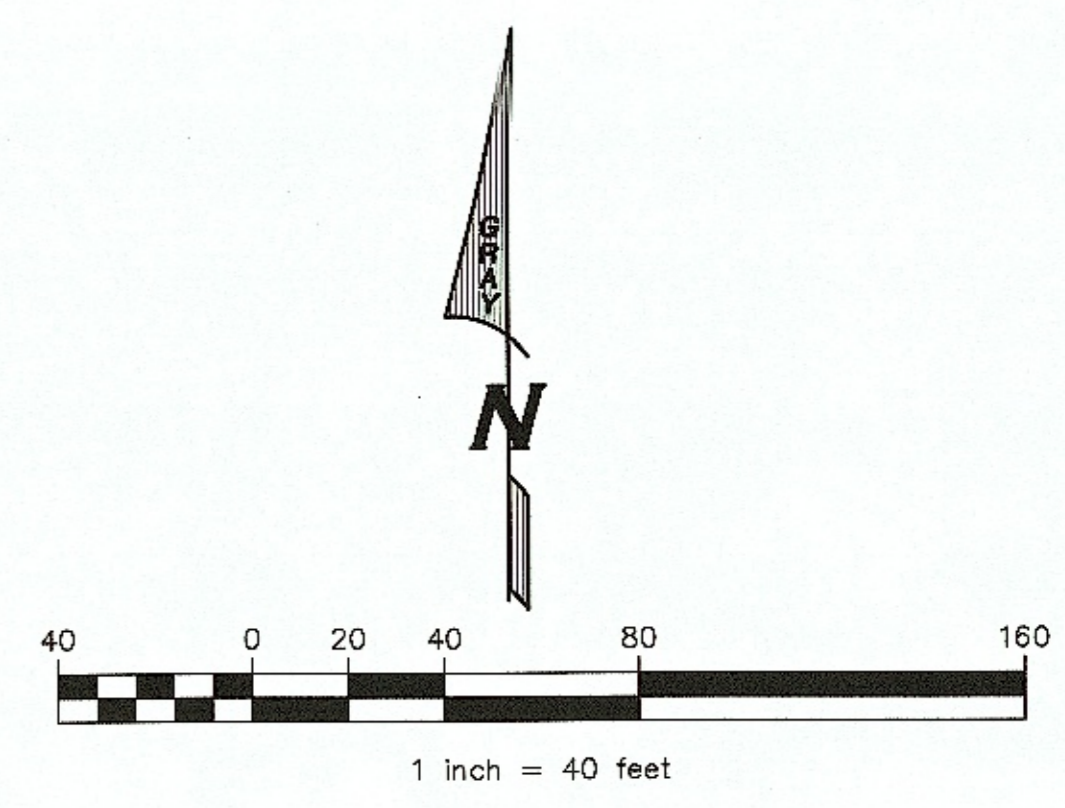
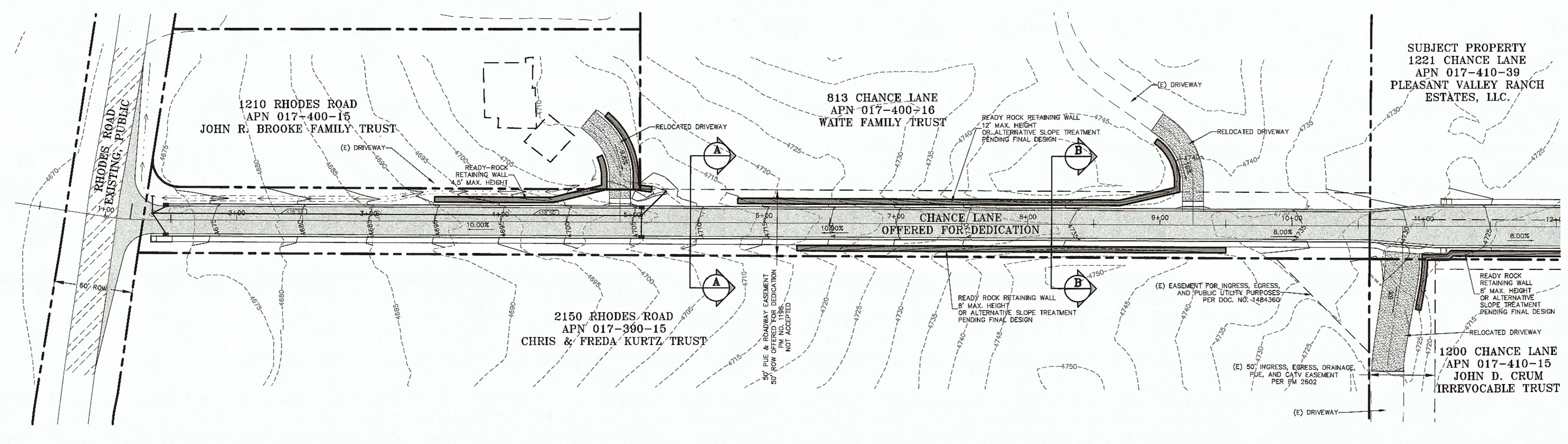
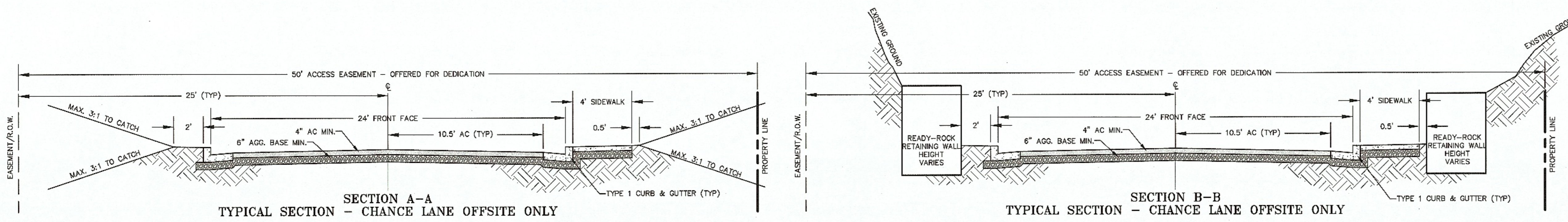

- LEGEND**
- (E) CONTOURS
 - (P) CONTOURS
 - (E) AC PAVEMENT TO REMAIN
 - (P) AC PAVEMENT
 - (P) GRAVEL DRIVEWAY
 - (P) SWALE
 - (P) STORM DRAIN WITH SIZE AND DIRECTION
 - (E) FENCE
 - (E) PROPERTY LINE
 - (E) EASEMENT LINE

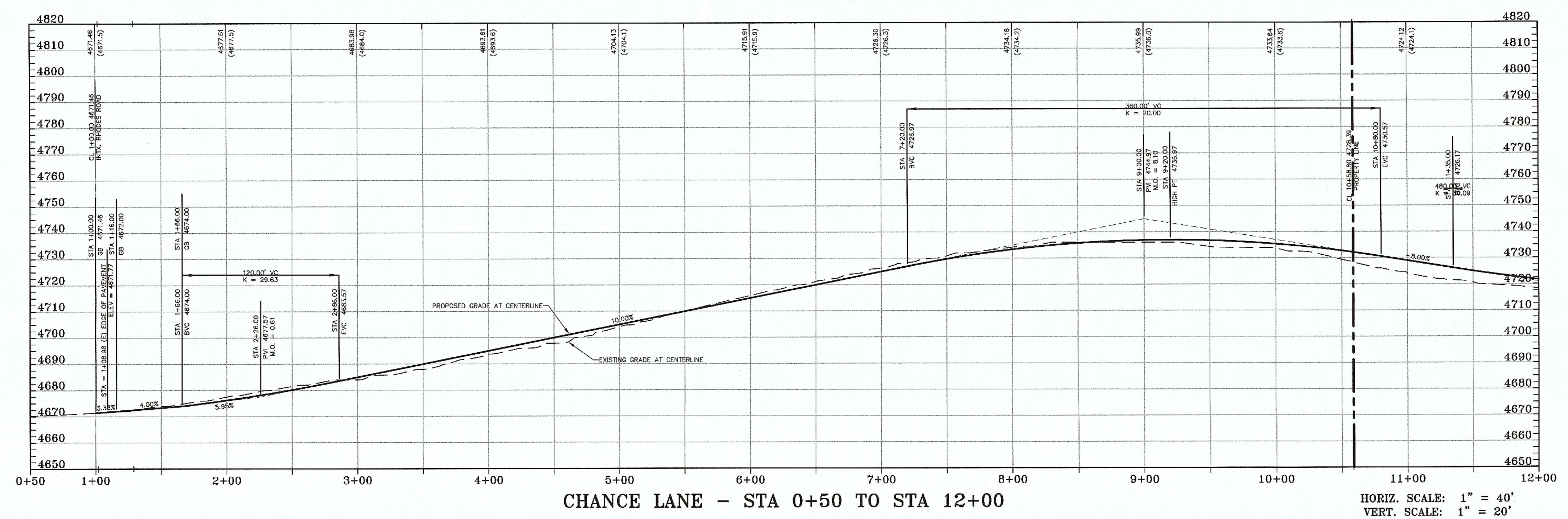

P:\000000\CHANCE LANE - PRIMARY ACCESS\DWG\CHANCE LANE - PRIMARY ACCESS.DWG, 2018-11-15 10:20:00 AM, 11/15/18

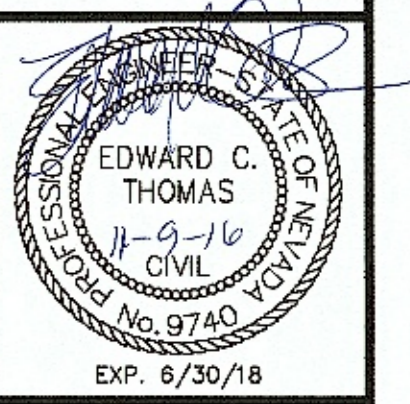

**PLEASANT VALLEY ESTATES
 TENTATIVE MAP
 ROCKY VISTA ROAD - EMERGENCY SECONDARY ACCESS**
 WASHOE COUNTY - NEVADA

REVISIONS	DATE

CLIENT No.: P068
 JOB No.: 16003
 DRAWN BY: ECT
 CHECKED BY:
 DATE: 11-16-16

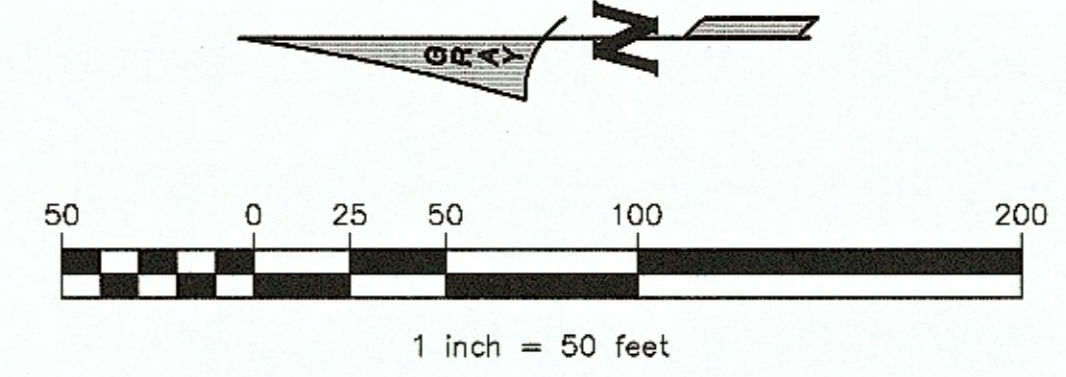
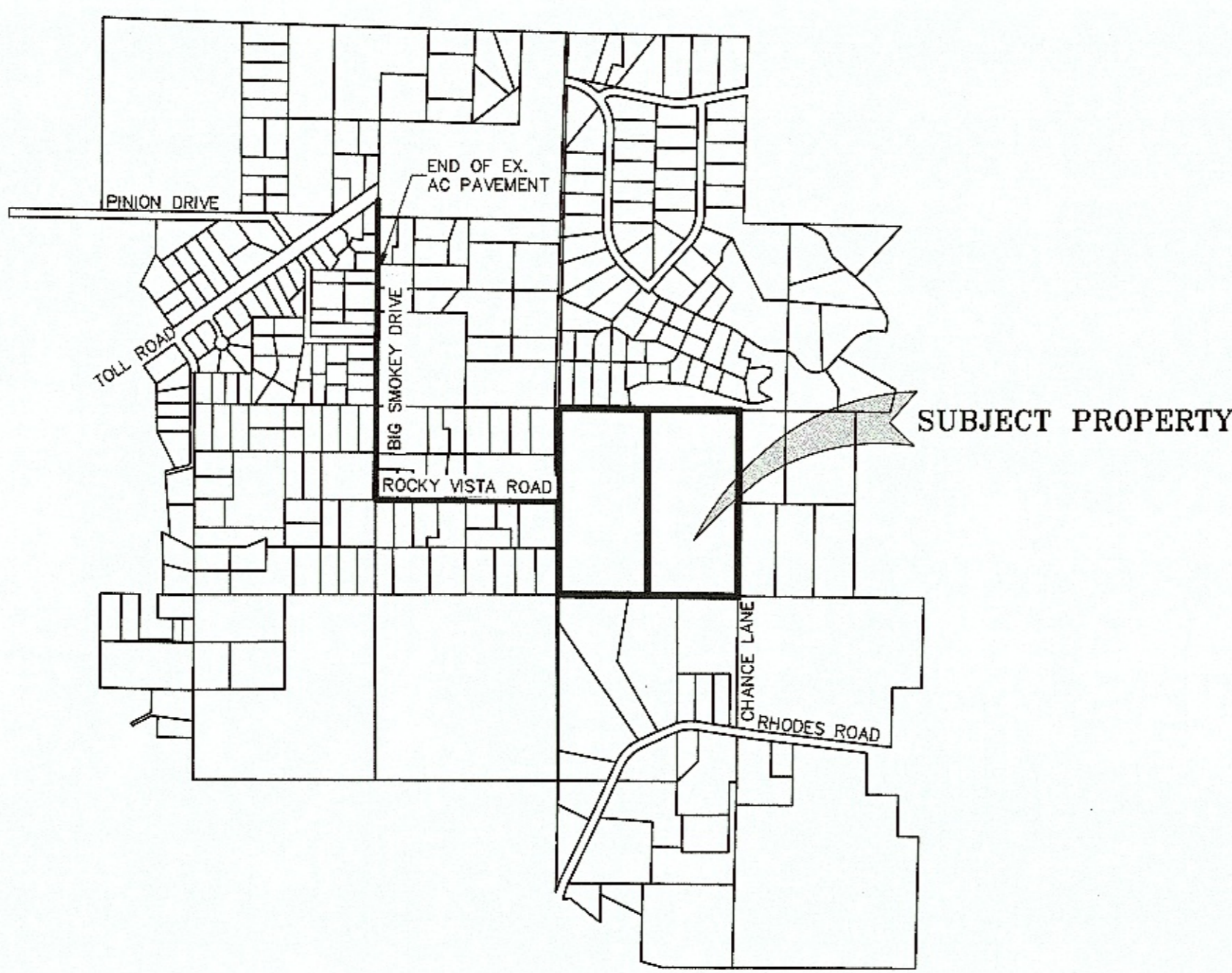

LEGEND
 (E) GRAVEL ROAD

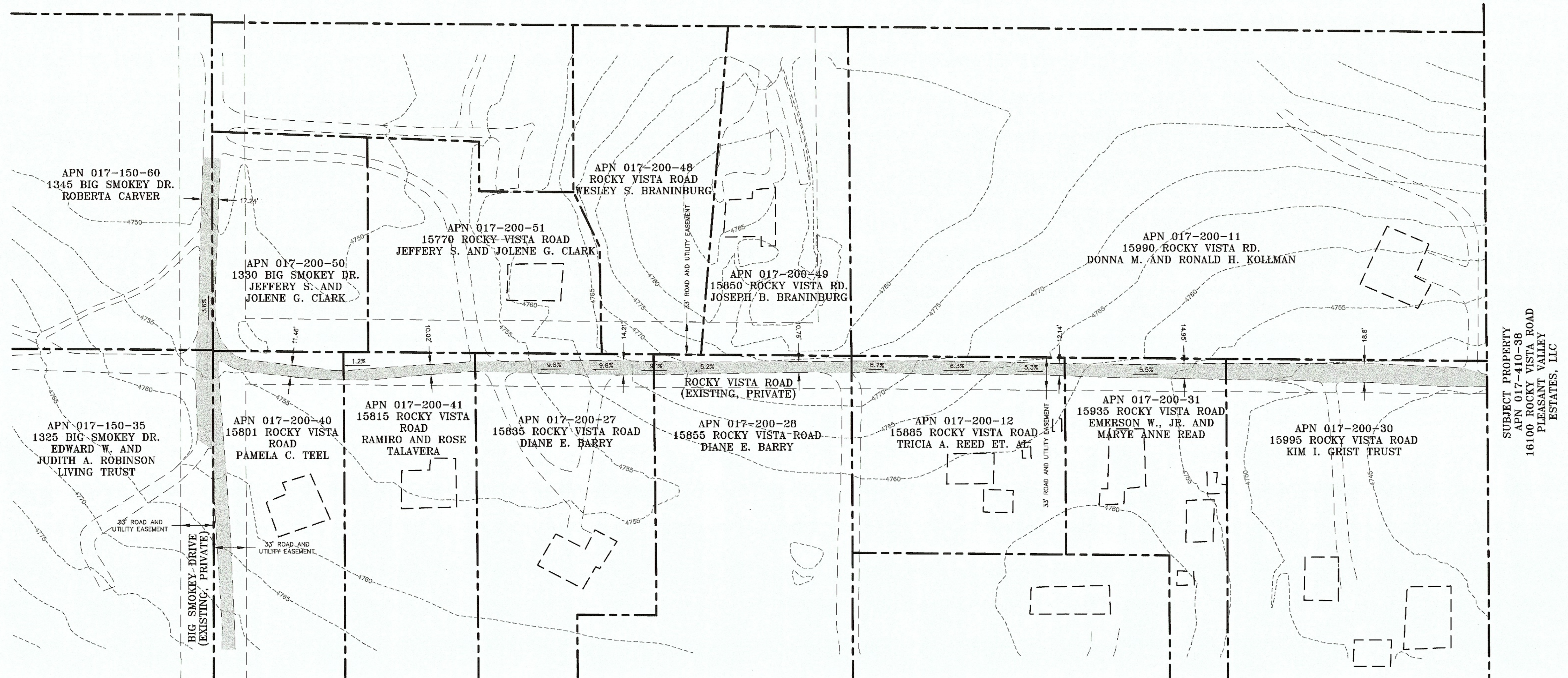

© 2016 GRAY & ASSOCIATES, INC. ALL RIGHTS RESERVED. THIS TENTATIVE MAP IS NOT TO BE USED FOR ANY OTHER PURPOSES WITHOUT THE WRITTEN CONSENT OF GRAY & ASSOCIATES, INC.



300 Western Road, #3, Reno, NV 89506 • (775) 852-7475 FAX (775) 852-7488

November 10, 2016
1149-07N

Dr. Harry Fry
760 Greenbrae Drive
Sparks, Nevada 89431

Site Assessment and Geotechnical Considerations
Proposed Pleasant Valley Estates
Washoe County, Nevada

Introduction

This report presents the results of the site assessment we performed and general geotechnical considerations we determined for the proposed Pleasant Valley Estates to be located in Washoe County, Nevada. The property is off of the existing street; Chance Lane, and listed as APN 017-410-38/39. We understand that this preliminary report is required as part of the tentative map application for the project. There are 2 large lots to be developed for single family housing tracks. The property will be serviced by community sewage disposal and water supply systems.

The scope of our work was to assess and review any pertinent site and geotechnical considerations, and comment on the anticipated affect, if any, to development of the property.

Site, Soil, Geologic and Flooding Conditions

At the time of our site visit, the property appears to have not been previously developed and was vegetated with an abundance of brush, few trees, and high grasses and weeds. The topography of the property is uneven due to natural drainage areas, but generally slopes down to the west. There are many boulders exposed on the surface of the lot, ranging to about 8 feet in size. These boulders are primarily granitic. The site is bounded by housing units on the north, and by undeveloped land on the south, east, and west. The soils in the area are granular in nature and of good quality. They are derived from weathering of the granitic rock.

The site is located just south of Reno, Nevada, which is within the extreme west central portion of the Basin and Range physiographic province. Based on the Preliminary Revised Geologic Maps of the Reno Urban Area, Nevada (Nevada Bureau of Mines and Geology, Alan R. Ramelli, Christopher Henry, and Jerome Walker, et.al., 2011), the site is underlain by Intermediate Aged Fan Deposits (Qfi), of Pleistocene Age.

No faults are located on site or in the vicinity. There is a regional potential for moderate to large magnitude earthquakes in the mid and western portions of Nevada. Washoe County currently requires the use of the site characterization criteria found in the 2012 International Building Code (IBC) for design. The seismic design criteria is found in Chapter 16, Section 1613 of the 2012 IBC and the USGS website. The IBC requires that the Site Class be determined by soil and rock parameters described in Table 1613.3.2. The Site Class defaults to "D" without confirming soil and rock data to a depth of 100 feet below the ground surface. The maximum considered earthquake ground motion spectral accelerations for short periods and for one second periods

are given on figures in the code. These values are mapped in contour format and estimated site values are determined by interpolation of the nearest contours. However, using the site latitude and longitude as input, the USGS website provides a much more accurate site specific acceleration values along with the respective site coefficients and design spectral response acceleration parameters in their Design Maps Summary Report. Based on this research, the site specific seismic design criteria for the subject property is presented below:

TABLE 1 - 2012 IBC SEISMIC DESIGN CRITERIA	
Spectral Response at Short Periods, S_s (USGS)	2.112
Spectral Response at 1-Second Period, S_1 (USGS)	0.687
Site Class (Subsection 1613.3.2)	D
Site Coefficient F_a (USGS)	1.000
Site Coefficient F_v (USGS)	1.499
Design Spectral Response Acceleration, Short Periods, $SD_s = 2/3 \times F_a \times S_s$ (USGS)	1.408
Design Spectral Response Acceleration, 1-Second Period, $SD_1 = 2/3 \times F_v \times S_1$ (USGS)	0.687

The Federal Emergency Management Agency (FEMA) Flood Insurance Rate Map (Panel No. 32019C0275E, January 16, 2009) indicates that the development area is within Flood Hazard Zone X. Zone X is designated as those areas determined to be outside the 0.2% annual chance floodplain.

Discussion and Conclusions

Our field reconnaissance, review of the available geological/geotechnical information and our experience in the site vicinity indicates that, in general, the site is suitable for typical single family housing development. We believe conventional construction, including normal mass cutting and filling for support of standard spread foundations for buildings and with associated concrete slabs-on-grade and/or asphaltic concrete exterior flatwork, can be used. Streets can be paved with conventional asphaltic concrete and aggregate base thickness design.

The native soils in the vicinity are medium dense, silty sands with gravel. Large cobbles or boulders may be encountered during excavation, based on what was observed on surface. Attention to encountering the large boulders at any depth and any bedrock deeper with the corresponding excavation difficulty should be anticipated. For deeper excavations, rock masses may be too large to move and blasting or other rock splitting technique may be needed. We will explore and test the fill soils, along with the native sands during the final geotechnical report phase and determine if the materials are suitable for reuse or need to be wasted. Our experience indicates that there are no zones of moderately to highly expansive native clayey soils in the vicinity. The buildings, on-site flatwork and public street improvement materials will be satisfactorily supported on existing fill materials that are approved for reuse with compaction and/or on firm native sands.

This report provides general information to aid the owners and/or developers in preliminary development planning and required for the tentative map application. It is not intended to be a complete geotechnical study. Prior to any serious development or construction plans, a complete

Dr. Harry Fry
Project: Pleasant Valley Estates
Project No.: 1149-07N
November 10, 2016 - Page 3

geotechnical investigation report developed through field exploration, laboratory testing and engineering analysis should be completed. The final report should provide engineering parameters of the soils across the site and specific recommendations concerning site preparation and grading with attention to the filling conditions, foundation design criteria and support of exterior flatwork and flexible pavements. Such a study could result in providing alternative recommendations which would help planners determine the most cost effective methods for development and construction.

We trust that this provides the information needed at this time. If you have any questions, please contact our office.

Yours very truly,

NORTECH Geotechnical/Civil Consultants, Ltd.

A handwritten signature in blue ink, appearing to read "Andrew J. Pikero".

Andrew J. Pikero
Engineering Intern - OT7618



Nicholas S. Vestbie
Civil Engineer - 5173

NSV/llm

cc: Gray & Associates
130 Vine Street
Reno, Nevada 89503

Conceptual Drainage Report

for

Pleasant Valley Estates Residential Subdivision Tentative Map Application

Washoe County, Nevada

Prepared for:

Pleasant Valley Estates, LLC.
301 Flint Street
Reno, NV 89501
(775) 846-9200

Prepared by:

Edward C. Thomas, P.E.
Gray & Associates
130 Vine St.
Reno, NV 89503
(775) 329-2911

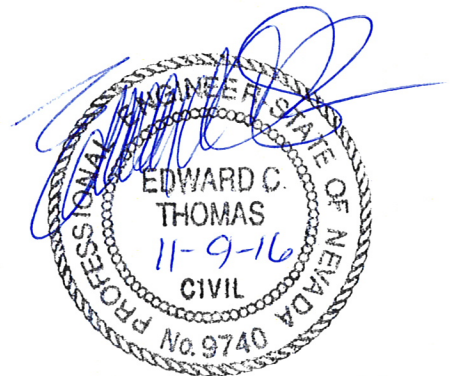

EXP. 6-30-18

October 27, 2016

P068-16003



INTRODUCTION

This report presents hydrologic and hydraulic calculations for the Pleasant Valley Estates Residential Subdivision project. Pleasant Valley Estates is located in the northeastern 1/4 of the northwestern 1/4 of Section 3, T.17N, R.20E., M.D.M. in Washoe County, Nevada. The property consists of two parcels (APN's 017-410-38 and 39; 16100 Rocky Vista Road and 1221 Chance Lane, respectively). The purpose of this study is to compute the 5-year and 100-year peak runoff for the undeveloped and improved condition and to provide supporting computations for the calculated peak runoff.

SITE DESCRIPTION

Pleasant Valley Estates is located in a small valley in the Pleasant Valley region of the unincorporated portion of Washoe County in southeast Reno, Nevada. Pleasant Valley Estates is located east of the eastern end of Chance Lane and south of the southern end of Rocky Vista Road. (See Vicinity Map, Appendix A). Both of the existing Pleasant Valley Estates parcels are currently split zoned. The northern parcel is zoned Medium Density Suburban (MDS) and Medium Density Rural (MDR). The southern parcel is zoned Low Density Suburban (LDS), MDR, and General Rural (GR). Properties to the north of Pleasant Valley Estates have been developed as residential properties with MDS zoning. Properties to the west of Pleasant Valley Estates have split zoning of MDS, MDR, and GR. Only one of the three adjoining parcels to the west has been developed. Two residential parcels abut the project site on the south. The western parcel is zoned MDR and the eastern parcel is zoned High Density Rural (HDR). Both properties to the south have been developed. The Majestic Ranch Estates Residential Subdivision borders the property on the east. Majestic Ranch Estates is primarily zoned LDS, but an area of MDR does border the southern half of the project site.

The northern parcel is currently accessed from the southern end of Rocky Vista Road. Topography of the parcel ranges from moderately sloping on the western border to mildly sloping in the middle to steeply sloping in the eastern third. The southern parcel is currently accessed from the eastern end of Chance Lane. Its topographic characteristics match the northern parcel. The site drains almost exclusively to an existing drainage swale that travels from north to south in the western third of the property. The swale was straightened at some point, but generally follows its natural course. At the southern end of the swale, a culvert carries runoff under an existing dirt driveway and deposits it on 1200 Chance Lane.

The northern parcel is 19.67 acres in area and is currently undeveloped. Groundcover consists of strong stands of native desert shrubs with the densest groundcover in the lower elevations. Upper elevations in the steepest portions of the site tend to be rocky with more native grasses than native shrubs. The southern parcel is also 19.67 acres in area and includes a single, occupied farm building in the northeastern corner of the middle third of the parcel. The building is accessed via an existing dirt driveway. Groundcover is similar to the northern parcel except for an area in the lower elevations that has been cleared for horse pastures.

An existing drainage swale runs from north to south across the western third of the parcel. As noted above, it has been straightened in the past but generally follows natural contours. The swale collects runoff from the entire project site as well as a large area to the north of the project site. Very strong stands of native shrubs line the swale and help protect it from erosion.

A single area of historical significance is located on the site. A boulder located in the western third of the southern parcel has been etched by a Paiute Chief in 1867. The area that includes the boulder will be protected and left undeveloped.

The currently proposed project will involve the construction of paved public roadways, development of residential lots, construction of utility services, and construction of a stormwater detention facility.

Slopes of the existing property exceed 15% over more than 34% of the site. Consequently, the project may be categorized as a Hillside Development as defined by Section 424 of the Washoe County Development Code. Roughly 4.5% of the site includes slopes in excess of 30%. These areas will not be developed.

FLOOD ZONE

Based on a review of the Flood Insurance Rate Map Number 32031C3351 G, effective date March 16, 2009 prepared by the Federal Emergency Management Agency (F.E.M.A.) the project site is identified as existing within Flood Hazard Zone X (unshaded), which is defined as areas determined to be outside the 500-year floodplain. The FEMA FIRM can be found in Appendix B.

PROJECT DESCRIPTION

The Pleasant Valley Estates Residential Subdivision project will be a lot-sales residential development of 54 residential parcels, two open-space parcels, and a detention pond/sewer pump station parcel. Public streets and utility infrastructure will be constructed, but individual parcels will remain undisturbed until individual property owners purchase them and apply for building permits. Catch slopes from streets will vary be 3:1. Some retaining walls will be constructed where existing ground slopes are too steep for 3:1 slopes to catch. Runoff will be collected in drainage swales and routed either to the existing swale that runs through the site from south to north or it will be collected in storm drain pipes. All runoff originating on the project site will be routed to a detention basin located at the natural low point of the site near the southern subdivision boundary. Unpaved disturbed areas will be revegetated with native shrubs and grasses. Revegetated areas will be temporarily until vegetation establishes to the point that coverage reaches 70% of pre-development coverage as recommended by the Environmental Protection Agency (EPA). Construction of streets and utilities will disturb roughly 9.1 acres.

The proposed detention pond will be sized to allow runoff from both the 5-year and 100-year return frequency storms to be reduced to existing peak rates prior to discharge from the site.

METHODOLOGY

Peak rate of runoff and total runoff volumes have been computed using the US Army Corps of Engineers' (USACE's) HEC-HMS software and the SCS Unit Hydrograph Method. Precipitation values were computed using National Oceanic and Atmospheric Administration's (NOAA's) Point Precipitation Frequency Estimates function available on the NOAA website, soil hydrologic characteristics were based upon the US Department of Agriculture Natural Resources Conservation Service (NRCS, formerly SCS) Soil Surveys, and concentration times were determined using the methods described in the Truckee Meadows Regional Drainage Manual (T-M Drainage).

In hydrograph theory, time of concentration is defined as the time from the end of excessive rainfall to the end of direct runoff. In practical calculations, time of concentration is the flow time from the most hydraulically remote point in a drainage basin to the point of discharge. Concentration time is therefore a combination of two related factors: initial overland flow time and concentrated flow time. The initial time is based on the distance travelled over the ground

surface prior to concentrating into organized channels (sheet flow). The minimum time of concentration is defined by T-M Drainage as 10 minutes.

The initial overland flow time is computed using the following equation:

$$t_i = \left[\frac{1.8(1.1 - R)L_0^{\frac{1}{2}}}{S^{\frac{1}{3}}} \right]$$

Where, t_i = Initial overland flow time (min)
 R = 5- year Runoff Coefficient (unitless)
 L_0 = Length of overland runoff (ft); 500 ft maximum
 S = Overland slope (%)

Time of concentrated flow is computed using the following equation:

$$t_n = \frac{L_n}{v_n \left(60 \frac{\text{min}}{\text{in}}\right)}$$

Where, t_n = Concentrated flow time for segment n (min)
 L_n = Length of concentrated flow segment n (unitless)
 v_n = Velocity of concentrated flow in segment n (ft)

Time of concentration (t_c) is therefore computed using the following equation:

$$t_c = t_i + \sum_{n=1}^n t_n$$

Lag time (t_l) is defined as the difference in time between the center of mass of excess rainfall to the center of mass of the runoff that is produced. From a practical standpoint, the lag time is estimated by the following equation:

$$t_l = (0.6)(t_c)$$

According to T-M Drainage, the peak rate of runoff may not be increased as a result of development. In the Pleasant Valley Estates project, runoff will be collected in swales, ditches, and storm drain pipes and conveyed to a single detention pond where it will be allowed to collect while it is released in a controlled manner. The existing drainage swale on the project site collects runoff from a sizeable drainage basin upstream of the project site. Upstream runoff will continue to be collected. It will be combined with on-site runoff and routed through the detention pond.

The detention pond will be fitted with a multi-stage outlet structure. The outlet structure will discharge runoff from the pond into an existing 24" culvert that is located at the southern end of the existing swale. The existing culvert discharges runoff onto the property immediately to the south of Pleasant Valley Estates. A lower outlet will control runoff from the 5-year return frequency storm and discharge at a rate no higher than the existing 5-year peak rate of runoff. A second outlet, set just above the 5-year ponding depth will control runoff from the 100-year return frequency storm and discharge at a rate no higher than the existing 100-year peak rate of runoff. The outlet structure will have two emergency spillways in the event that either the lower outlets should become clogged or a storm that is greater than the expected 100-year storm should reach the pond. The primary emergency outlet will be a stand pipe at the location of the two primary outlets. The secondary emergency outlet will allow runoff to back up into Chance Lane and ultimately spill over onto property to the south. This outlet will be armored to reduce the chance of damaging runoff.

According to T-M Drainage, for flow-based facilities, runoff from the 2-year return frequency storm must be treated to remove pollutants. Swales located in the detention basin will be fitted with rock check dams, and the entire detention pond will be revegetated using native plant species. These measures will be sized to remove pollutants from runoff prior to discharge from the project site. All runoff originating on the paved surfaces will be routed to the detention pond. Consequently, 100% of runoff originating on the paved surfaces will be treated.

The result is that 100% of runoff originating on the project site will be reduced to the peak rate prior to development and treated for pollutant removal.

EXISTING RUNOFF ANALYSIS

The existing Pleasant Valley Estates site drains almost entirely from all directions into the existing swale located in the western third of the property. A 0.3-acre area located in the northeast corner of the site, an area of 0.24 acres in the southeast corner of the property, and two areas, totaling 0.97 acres, in the southern portion of the site drain onto adjacent properties as sheet flow. An area of approximately 21.2 acres to the north of the project site, an area of approximately three acres to the west of the project site, and an area of approximately 1.2 acres to the south of the project site drain onto the project site and into the existing drainage swale. For purposes of this report, no distinction will be made between onsite and offsite runoff that reaches the drainage swale above its point of discharge from the Pleasant Valley Estates project site. The sizing of the detention pond will be based upon all runoff reaching the subdivision discharge point regardless of origin.

The small existing areas that drain offsite will not be considered in the project calculations for the following reasons:

1. The areas are too small to register any runoff when modeled using HEC-HMS.
2. The small areas in the northeast and southeast corners of the site that drain onto neighboring properties will not be disturbed with development. Consequently, there will be no change in the hydrologic condition and therefore no impact on neighboring properties.
3. The southern areas that drain offsite in the existing condition will be cut off by the extension of Chance Lane and routed into the detention pond when the project is developed. As such, these areas will no longer impact offsite development, and any comparison between the existing and proposed hydrologic state becomes irrelevant.

Table 1. Existing Conditions: Peak Runoff

Subarea	Area (ac)	CN	t_c (min)	t_l (min)	P_5 (in)	P_{100} (in)	% Impervious	Q_5 (cfs)	Q_{100} (cfs)	V_5 (ac-ft)	V_{100} (ac-ft)
E-1	63.47	68	20.85	12.51	0.36	0.87	1.56	1.9	9.2	0.20	0.80

Where: CN = SCS Runoff Curve Number from NRCS Soil Studies
 t_c = Time of Concentration - computed
 t_l = Lag Time (or basin lag) - computed
 P_5 = 5-year Precipitation from NOAA
 P_{100} = 100-year Precipitation from NOAA
 Q_5 = 5-year Peak Runoff Rate - computed
 Q_{100} = 100-year Peak Runoff Rate - computed
 V_5 = 5-year Runoff Volume - computed
 V_{100} = 100-year Peak Runoff Volume - computed

Calculations can be found in Appendix C.

PROPOSED RUNOFF ANALYSIS

Development of the Pleasant Valley Estates Residential Development will involve the construction of paved roadways, drainage swales, a stormwater detention facility, and public utilities. The construction of the roadways and swales will alter the course of much of the runoff originating on the site. Where possible, runoff will be routed via drainage swales to the existing on-site drainage swale which will discharge into the proposed stormwater detention pond. Where this is not possible, runoff will be collected in storm drain pipes and routed directly to the proposed stormwater detention pond. Offsite areas that currently drain onto the Pleasant Valley Estates site will be allowed to drain onto the site after development. Runoff originating offsite will be routed through the on-site detention pond. The detention pond will be sized to contain all runoff reaching it and discharge at the rate that currently leaves the site via the existing 24" diameter culvert located at the southern end of the existing drainage swale.

Table 2 represents the hydrologic characteristics of the developed site.

Table 2. Developed Conditions: Peak Runoff Reaching Detention Pond

Subarea	Area (ac)	CN	t_c (min)	t_l (min)	P_5 (in)	P_{100} (in)	% Impervious	Q_5 (cfs)	Q_{100} (cfs)	V_5 (ac-ft)	V_{100} (ac-ft)
P-1	66.29	68	20.85	12.51	0.36	0.87	17.66	5.2	16.4	0.50	1.4

All calculations were performed by hand and can be found in Appendix C.

As can be seen by comparing Table 1 and Table 2, peak developed runoff reaching the 24" culvert has been increased as a result of development. This is entirely due to an increase in the amount of impervious ground cover in the form of streets, driveways, and roofs. The concentration time, and therefore the lag time does not change because the primary drainage route from the properties to the north of the site and through the existing drainage swale does not change with development.

In order to reduce peak runoff to existing conditions, runoff must be allowed to back up and be stored while it is metered out of the detention pond. In theory, the amount of storage required is the difference between the volume of runoff generated in the developed condition and the runoff generated in the existing condition. In practice, the amount of storage required is actually larger than the difference between the two conditions because it is almost impossible to create an outlet structure that exactly mimics the existing flow hydrograph.

In the case of Pleasant Valley Estates, the difference in 100-year runoff volume between the existing and proposed conditions is 0.6 ac-ft. The detention pond has been designed with a maximum storage capacity of 0.89 ac-ft. This volume should be adequate to store excess runoff without overtopping the pond and provide some extra storage in the event of a larger storm.

The detention pond will be fitted with a multi-stage outlet structure. The outlet structure will discharge runoff from the pond into the existing 24" culvert that is located at the southern end of the existing drainage swale. The existing culvert discharges runoff onto the property immediately to the south of Pleasant Valley Estates. A lower outlet will control runoff from the 5-year return frequency storm and discharge at a rate no higher than the existing 5-year peak rate of runoff. A second outlet, set just above the 5-year ponding depth will control runoff from the 100-year return frequency storm and discharge at a rate no higher than the existing 100-year peak rate of runoff. The outlet structure will have two emergency spillways in the event that

either the lower outlets should become clogged or a storm that is greater than the expected 100-year storm should reach the pond. The primary emergency outlet will be a stand pipe at the location of the two primary outlets. The secondary emergency outlet will allow runoff to back up into Chance Lane and ultimately spill over onto property to the south. This outlet will be armored to reduce the chance of damaging runoff should it ever come to use.

CONCLUSION

The Pleasant Valley Estates Residential Subdivision project will be a lot-sales residential development of 54 residential parcels, two open-space parcels, and a detention pond/sewer pump station parcel. Public streets and utility infrastructure will be constructed, but individual parcels will remain undisturbed until individual property owners purchase them and apply for building permits. Development of the project will result in a marked increase in impervious ground cover. The increase in impervious ground cover will cause an increase in peak runoff generated by the project. To reduce peak runoff back to existing levels, a detention pond with a multi-stage outlet will be constructed. The detention pond will be sized to reduce peak runoff from the 100-year return frequency storm.

All disturbed ground surfaces which are not paved will be re-vegetated using native shrubs and grasses. Revegetated areas will be irrigated until revegetation is established to the point that coverage is at least 70% of existing coverage density. By revegetating disturbed slopes and by lining cutoff ditches with rip-rap, erosion and sedimentation can be minimized.

Washoe County Code requires that the 5-year and 100-year peak runoff leaving a developed site not exceed the peak runoff leaving the site in its undeveloped state. Washoe County policy requires that runoff be treated to remove pollutants from 90% of storms prior to discharge from the site. The proposed improvements are expected to meet both of these standards.

APPENDIX A

VICINITY MAP

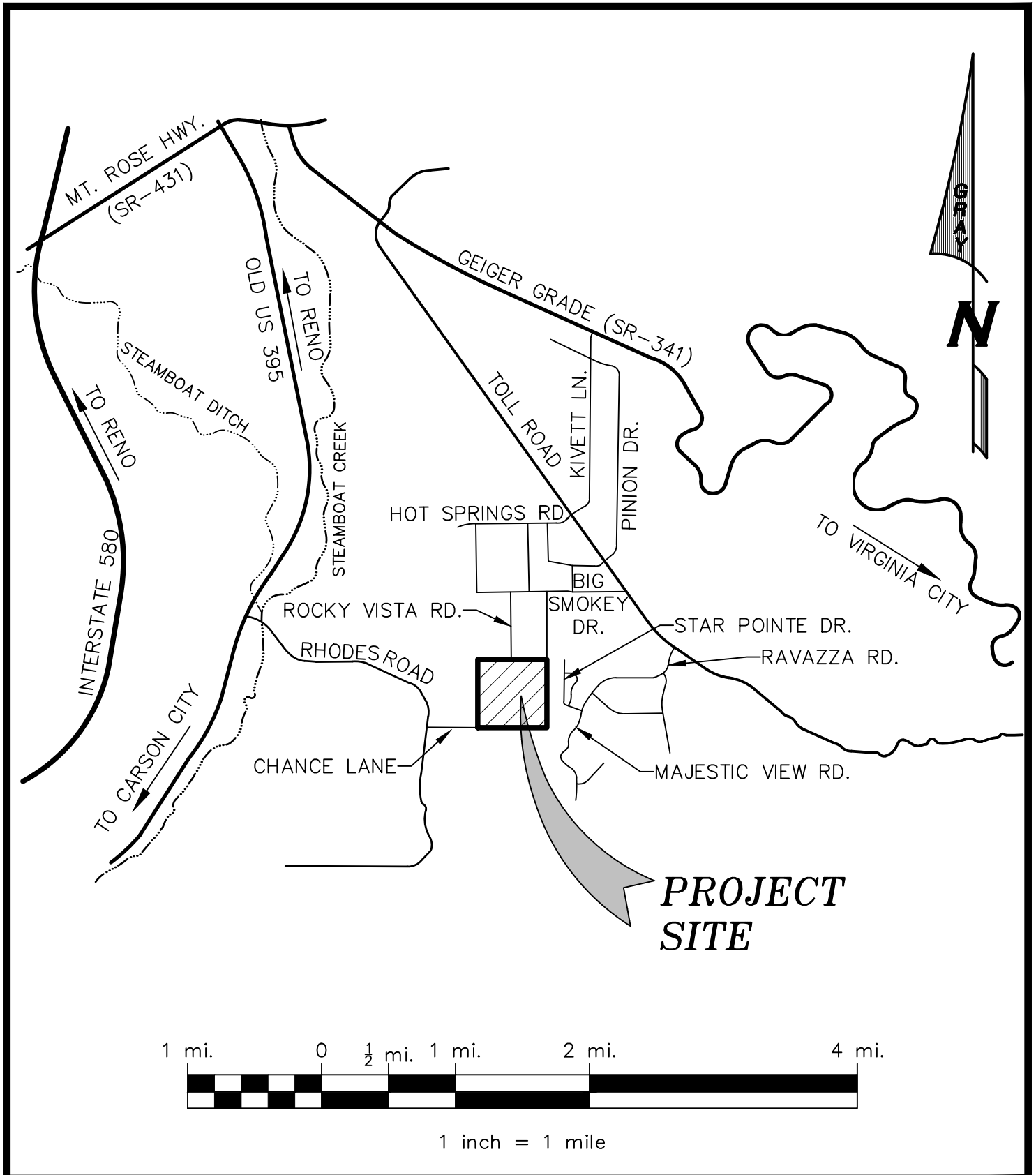

PLEASANT VALLEY ESTATES
 TENTATIVE MAP
 VICINITY MAP

SCALE: 1"=1mi.
 DRAWN BY: ECT
 DATE: 10-17-16
 JOB NO.: 16003



Gray & Associates INC.
 CIVIL ENGINEERS * PLANNERS * SURVEYORS
 130 Vine Street Reno, Nevada 89503
 (775) 329-2911 * (775) 329-6469 Fax * admin@grayassociates.net

APPENDIX B

FEMA FIRM and PRECIPITATION CURVES

NATIONAL FLOOD INSURANCE PROGRAM



MAP SCALE 1" = 500'

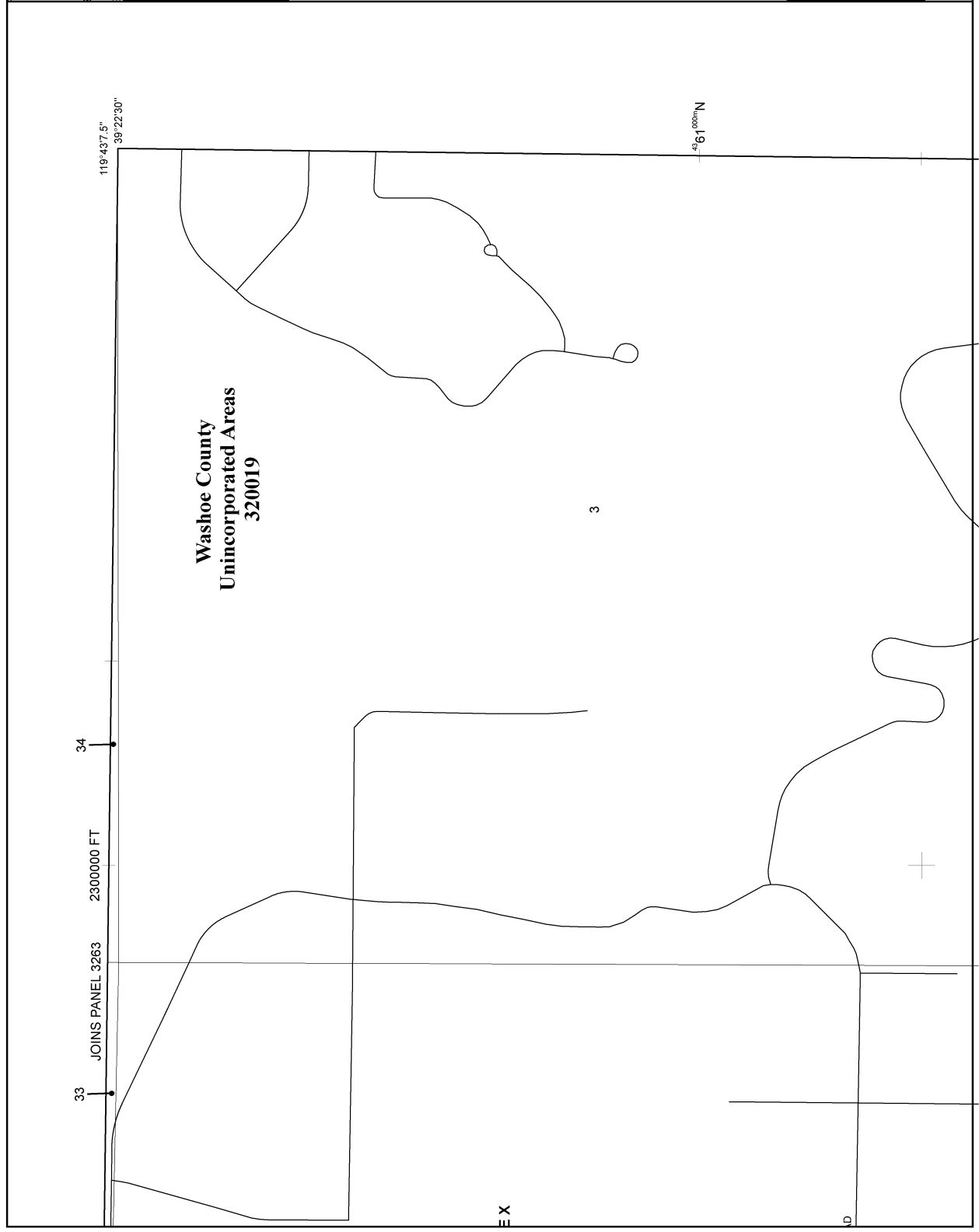
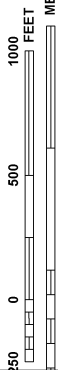

NATIONAL FLOOD INSURANCE PROGRAM

NFIP

PANEL 3351G

FIRM

FLOOD INSURANCE RATE MAP

WASHOE COUNTY,
NEVADA
AND INCORPORATED AREAS

PANEL 3351 OF 3475

(SEE MAP INDEX FOR FIRM PANEL LAYOUT)

CONTAINS

COMMUNITY
WASHOE COUNTY

NUMBER
320019

PANEL
3351

SUFFIX
G

Note to User: The Map Number shown below should be checked against the current map sheets and any amendments which may have been made subsequent to the date on the title block. For the latest product information about National Flood Insurance Program flood maps check the FEMA Flood Map Store at www.nrc.fema.gov



MAP NUMBER
32031C3351G
MAP REVISED
MARCH 16, 2009

Federal Emergency Management Agency

This is an official copy of a portion of the above referenced flood map. It contains only the information shown on the map and does not include any other information or amendments which may have been made subsequent to the date on the title block. For the latest product information about National Flood Insurance Program flood maps check the FEMA Flood Map Store at www.nrc.fema.gov

Rainfall Depth



POINT PRECIPITATION FREQUENCY ESTIMATES

Sanja Perica, Sarah Dietz, Sarah Heim, Lillian Hiner, Kazungu Maitaria, Deborah Martin, Sandra Pavlovic, Ishani Roy, Carl Trypaluk, Dale Unruh, Fenglin Yan, Michael Yekta, Tan Zhao, Geoffrey Bonnin, Daniel Brewer, Li-Chuan Chen, Tye Parzybok, John Yarchoan

NOAA, National Weather Service, Silver Spring, Maryland

[PF tabular](#) | [PF graphical](#) | [Maps & aerials](#)

PF tabular

PDS-based point precipitation frequency estimates with 90% confidence intervals (in inches) ¹										
Duration	Average recurrence interval (years)									
	1	2	5	10	25	50	100	200	500	1000
5-min	0.100 (0.086-0.118)	0.125 (0.107-0.148)	0.167 (0.142-0.199)	0.207 (0.175-0.246)	0.273 (0.224-0.326)	0.333 (0.265-0.403)	0.404 (0.311-0.496)	0.491 (0.363-0.615)	0.629 (0.438-0.812)	0.755 (0.501-0.997)
10-min	0.153 (0.131-0.180)	0.190 (0.163-0.226)	0.254 (0.217-0.302)	0.315 (0.266-0.374)	0.415 (0.341-0.497)	0.506 (0.404-0.613)	0.615 (0.474-0.755)	0.746 (0.552-0.935)	0.957 (0.666-1.24)	1.15 (0.763-1.52)
15-min	0.189 (0.162-0.223)	0.236 (0.202-0.280)	0.315 (0.268-0.375)	0.390 (0.330-0.464)	0.514 (0.423-0.616)	0.628 (0.500-0.760)	0.763 (0.587-0.935)	0.925 (0.684-1.16)	1.19 (0.826-1.53)	1.43 (0.946-1.88)
30-min	0.255 (0.219-0.301)	0.318 (0.272-0.377)	0.424 (0.361-0.505)	0.526 (0.445-0.625)	0.693 (0.570-0.829)	0.845 (0.674-1.02)	1.03 (0.791-1.26)	1.25 (0.922-1.56)	1.60 (1.11-2.06)	1.92 (1.27-2.53)
60-min	0.315 (0.271-0.372)	0.393 (0.337-0.466)	0.525 (0.447-0.624)	0.650 (0.551-0.773)	0.857 (0.705-1.03)	1.05 (0.834-1.27)	1.27 (0.979-1.56)	1.54 (1.14-1.93)	1.98 (1.38-2.55)	2.38 (1.58-3.13)
2-hr	0.418 (0.369-0.483)	0.520 (0.459-0.600)	0.666 (0.581-0.767)	0.792 (0.682-0.912)	0.982 (0.824-1.14)	1.15 (0.944-1.35)	1.35 (1.08-1.61)	1.60 (1.23-1.95)	2.03 (1.50-2.58)	2.43 (1.73-3.16)
3-hr	0.503 (0.446-0.571)	0.626 (0.561-0.714)	0.785 (0.695-0.892)	0.912 (0.802-1.04)	1.09 (0.944-1.25)	1.25 (1.06-1.44)	1.43 (1.19-1.67)	1.67 (1.36-1.99)	2.08 (1.65-2.60)	2.47 (1.90-3.20)
6-hr	0.704 (0.626-0.793)	0.880 (0.784-0.996)	1.09 (0.966-1.23)	1.26 (1.10-1.42)	1.47 (1.28-1.67)	1.64 (1.40-1.87)	1.80 (1.52-2.09)	2.00 (1.65-2.35)	2.32 (1.87-2.77)	2.63 (2.08-3.22)
12-hr	0.927 (0.825-1.04)	1.17 (1.04-1.32)	1.47 (1.30-1.66)	1.70 (1.50-1.92)	2.01 (1.75-2.30)	2.25 (1.93-2.59)	2.50 (2.11-2.90)	2.74 (2.27-3.23)	3.07 (2.47-3.69)	3.34 (2.63-4.08)
24-hr	1.14 (1.03-1.27)	1.42 (1.29-1.59)	1.80 (1.63-2.00)	2.10 (1.89-2.34)	2.53 (2.26-2.82)	2.86 (2.53-3.19)	3.21 (2.82-3.61)	3.57 (3.10-4.05)	4.07 (3.47-4.66)	4.46 (3.75-5.16)
2-day	1.35 (1.21-1.52)	1.69 (1.51-1.91)	2.15 (1.92-2.43)	2.52 (2.24-2.85)	3.04 (2.68-3.44)	3.45 (3.02-3.92)	3.88 (3.35-4.45)	4.33 (3.70-5.01)	4.95 (4.14-5.81)	5.44 (4.47-6.49)
3-day	1.49 (1.34-1.67)	1.87 (1.68-2.11)	2.40 (2.15-2.70)	2.83 (2.53-3.18)	3.43 (3.04-3.87)	3.92 (3.44-4.43)	4.43 (3.85-5.05)	4.98 (4.27-5.71)	5.75 (4.82-6.68)	6.36 (5.24-7.49)
4-day	1.63 (1.47-1.83)	2.06 (1.85-2.30)	2.65 (2.38-2.97)	3.13 (2.81-3.51)	3.83 (3.40-4.29)	4.39 (3.86-4.94)	4.99 (4.34-5.64)	5.63 (4.83-6.40)	6.54 (5.49-7.54)	7.28 (6.02-8.50)
7-day	1.91 (1.70-2.15)	2.42 (2.15-2.72)	3.14 (2.80-3.54)	3.72 (3.30-4.20)	4.54 (4.00-5.13)	5.19 (4.53-5.88)	5.88 (5.08-6.69)	6.60 (5.65-7.57)	7.61 (6.40-8.85)	8.42 (6.98-9.89)
10-day	2.12 (1.88-2.39)	2.70 (2.40-3.05)	3.52 (3.13-3.98)	4.17 (3.69-4.71)	5.06 (4.45-5.74)	5.76 (5.03-6.55)	6.50 (5.62-7.41)	7.25 (6.21-8.32)	8.28 (6.98-9.62)	9.10 (7.58-10.7)
20-day	2.59 (2.31-2.91)	3.29 (2.94-3.71)	4.29 (3.83-4.82)	5.05 (4.49-5.67)	6.07 (5.38-6.83)	6.86 (6.04-7.75)	7.66 (6.68-8.70)	8.47 (7.33-9.67)	9.56 (8.15-11.0)	10.4 (8.76-12.1)
30-day	2.98 (2.67-3.36)	3.80 (3.40-4.28)	4.93 (4.40-5.55)	5.79 (5.15-6.51)	6.94 (6.14-7.82)	7.82 (6.87-8.84)	8.71 (7.60-9.90)	9.61 (8.31-11.0)	10.8 (9.22-12.5)	11.7 (9.89-13.7)
45-day	3.54 (3.17-3.94)	4.51 (4.03-5.02)	5.84 (5.22-6.48)	6.81 (6.08-7.55)	8.08 (7.19-8.97)	9.01 (7.99-10.0)	9.92 (8.75-11.1)	10.8 (9.47-12.1)	11.9 (10.3-13.4)	12.7 (10.9-14.4)
60-day	4.08 (3.63-4.56)	5.21 (4.64-5.82)	6.75 (6.01-7.52)	7.84 (6.97-8.72)	9.21 (8.18-10.3)	10.2 (9.02-11.4)	11.1 (9.81-12.5)	12.0 (10.5-13.5)	13.1 (11.4-14.8)	13.8 (12.0-15.7)

Rainfall Intensity

NOAA Atlas 14, Volume 1, Version 5

Location name: Reno, Nevada, US*

Latitude: 39.3741°, Longitude: -119.7277°

Elevation: 4734 ft*

* source: Google Maps



POINT PRECIPITATION FREQUENCY ESTIMATES

Sanja Perica, Sarah Dietz, Sarah Heim, Lillian Hiner, Kazungu Maitaria, Deborah Martin, Sandra Pavlovic, Ishani Roy, Carl Trypaluk, Dale Unruh, Fenglin Yan, Michael Yekta, Tan Zhao, Geoffrey Bonnin, Daniel Brewer, Li-Chuan Chen, Tye Parzybok, John Yarchoan

NOAA, National Weather Service, Silver Spring, Maryland

[PF tabular](#) | [PF graphical](#) | [Maps & aerials](#)

PF tabular

PDS-based point precipitation frequency estimates with 90% confidence intervals (in inches/hour) ¹										
Duration	Average recurrence interval (years)									
	1	2	5	10	25	50	100	200	500	1000
5-min	1.20 (1.03-1.42)	1.50 (1.28-1.78)	2.00 (1.70-2.39)	2.48 (2.10-2.95)	3.28 (2.69-3.91)	4.00 (3.18-4.84)	4.85 (3.73-5.95)	5.89 (4.36-7.38)	7.55 (5.26-9.74)	9.06 (6.01-12.0)
10-min	0.918 (0.786-1.08)	1.14 (0.978-1.36)	1.52 (1.30-1.81)	1.89 (1.60-2.24)	2.49 (2.05-2.98)	3.04 (2.42-3.68)	3.69 (2.84-4.53)	4.48 (3.31-5.61)	5.74 (4.00-7.41)	6.89 (4.58-9.10)
15-min	0.756 (0.648-0.892)	0.944 (0.808-1.12)	1.26 (1.07-1.50)	1.56 (1.32-1.86)	2.06 (1.69-2.46)	2.51 (2.00-3.04)	3.05 (2.35-3.74)	3.70 (2.74-4.64)	4.74 (3.30-6.12)	5.70 (3.78-7.52)
30-min	0.510 (0.438-0.602)	0.636 (0.544-0.754)	0.848 (0.722-1.01)	1.05 (0.890-1.25)	1.39 (1.14-1.66)	1.69 (1.35-2.05)	2.05 (1.58-2.52)	2.49 (1.84-3.12)	3.19 (2.22-4.12)	3.84 (2.55-5.06)
60-min	0.315 (0.271-0.372)	0.393 (0.337-0.466)	0.525 (0.447-0.624)	0.650 (0.551-0.773)	0.857 (0.705-1.03)	1.05 (0.834-1.27)	1.27 (0.979-1.56)	1.54 (1.14-1.93)	1.98 (1.38-2.55)	2.38 (1.58-3.13)
2-hr	0.209 (0.184-0.242)	0.260 (0.230-0.300)	0.333 (0.290-0.384)	0.396 (0.341-0.456)	0.491 (0.412-0.570)	0.576 (0.472-0.676)	0.674 (0.538-0.804)	0.798 (0.615-0.974)	1.02 (0.748-1.29)	1.22 (0.864-1.58)
3-hr	0.167 (0.149-0.190)	0.208 (0.187-0.238)	0.261 (0.231-0.297)	0.304 (0.267-0.346)	0.363 (0.314-0.416)	0.415 (0.353-0.480)	0.475 (0.396-0.557)	0.556 (0.453-0.661)	0.694 (0.548-0.867)	0.822 (0.633-1.06)
6-hr	0.118 (0.105-0.132)	0.147 (0.131-0.166)	0.182 (0.161-0.206)	0.210 (0.184-0.237)	0.245 (0.213-0.280)	0.273 (0.234-0.313)	0.301 (0.254-0.349)	0.334 (0.276-0.393)	0.387 (0.312-0.462)	0.439 (0.347-0.538)
12-hr	0.077 (0.068-0.087)	0.097 (0.086-0.109)	0.122 (0.108-0.138)	0.141 (0.124-0.160)	0.167 (0.145-0.190)	0.187 (0.160-0.215)	0.207 (0.175-0.241)	0.228 (0.189-0.268)	0.255 (0.205-0.306)	0.277 (0.219-0.338)
24-hr	0.047 (0.043-0.053)	0.059 (0.054-0.066)	0.075 (0.068-0.084)	0.088 (0.079-0.098)	0.105 (0.094-0.117)	0.119 (0.106-0.133)	0.134 (0.117-0.150)	0.149 (0.129-0.169)	0.169 (0.145-0.194)	0.186 (0.156-0.215)
2-day	0.028 (0.025-0.032)	0.035 (0.032-0.040)	0.045 (0.040-0.051)	0.053 (0.047-0.059)	0.063 (0.056-0.072)	0.072 (0.063-0.082)	0.081 (0.070-0.093)	0.090 (0.077-0.104)	0.103 (0.086-0.121)	0.113 (0.093-0.135)
3-day	0.021 (0.019-0.023)	0.026 (0.023-0.029)	0.033 (0.030-0.037)	0.039 (0.035-0.044)	0.048 (0.042-0.054)	0.054 (0.048-0.062)	0.062 (0.053-0.070)	0.069 (0.059-0.079)	0.080 (0.067-0.093)	0.088 (0.073-0.104)
4-day	0.017 (0.015-0.019)	0.021 (0.019-0.024)	0.028 (0.025-0.031)	0.033 (0.029-0.037)	0.040 (0.035-0.045)	0.046 (0.040-0.051)	0.052 (0.045-0.059)	0.059 (0.050-0.067)	0.068 (0.057-0.079)	0.076 (0.063-0.089)
7-day	0.011 (0.010-0.013)	0.014 (0.013-0.016)	0.019 (0.017-0.021)	0.022 (0.020-0.025)	0.027 (0.024-0.031)	0.031 (0.027-0.035)	0.035 (0.030-0.040)	0.039 (0.034-0.045)	0.045 (0.038-0.053)	0.050 (0.042-0.059)
10-day	0.009 (0.008-0.010)	0.011 (0.010-0.013)	0.015 (0.013-0.017)	0.017 (0.015-0.020)	0.021 (0.019-0.024)	0.024 (0.021-0.027)	0.027 (0.023-0.031)	0.030 (0.026-0.035)	0.035 (0.029-0.040)	0.038 (0.032-0.044)
20-day	0.005 (0.005-0.006)	0.007 (0.006-0.008)	0.009 (0.008-0.010)	0.011 (0.009-0.012)	0.013 (0.011-0.014)	0.014 (0.013-0.016)	0.016 (0.014-0.018)	0.018 (0.015-0.020)	0.020 (0.017-0.023)	0.022 (0.018-0.025)
30-day	0.004 (0.004-0.005)	0.005 (0.005-0.006)	0.007 (0.006-0.008)	0.008 (0.007-0.009)	0.010 (0.009-0.011)	0.011 (0.010-0.012)	0.012 (0.011-0.014)	0.013 (0.012-0.015)	0.015 (0.013-0.017)	0.016 (0.014-0.019)
45-day	0.003 (0.003-0.004)	0.004 (0.004-0.005)	0.005 (0.005-0.006)	0.006 (0.006-0.007)	0.007 (0.007-0.008)	0.008 (0.007-0.009)	0.009 (0.008-0.010)	0.010 (0.009-0.011)	0.011 (0.010-0.012)	0.012 (0.010-0.013)
60-day	0.003 (0.003-0.003)	0.004 (0.003-0.004)	0.005 (0.004-0.005)	0.005 (0.005-0.006)	0.006 (0.006-0.007)	0.007 (0.006-0.008)	0.008 (0.007-0.009)	0.008 (0.007-0.009)	0.009 (0.008-0.010)	0.010 (0.008-0.011)

APPENDIX C

SUPPORTING CALCULATIONS

PEASANT VALLEY ESTATES

EXISTING HYDROLOGY

AREA E1 - AREA CONTRIBUTING TO 24" CULVERT
AT SOUTH PROPERTY BOUNDARY:

$$A = 2,764,914 \text{ SF} = 63.47 \text{ ac}$$

TOTAL DISTANCE TO HYDRAULICALLY MOST DISTANT POINT
= 3522 FT

FROM "TRULLEE MEADOWS REGIONAL DRAINAGE MANUAL"

$$t_i = \frac{1.8(1.1-R)L_0^{1/2}}{S^{1/3}} \quad (\text{EQN. 702})$$

WHERE: t_i = INITIAL OR OVERLAND FLOW TIME (MIN)

R = RUNOFF COEFFICIENT

L_0 = LENGTH OF OVERLAND FLOW (FT); 500' MAX.

S = AVERAGE OVERLAND BASIN SLOPE (%)

FROM NRCS, PRIMARY SOIL TYPE IS 882-
ZEPHAN STONY, SANDY LOAM

- HIGH RUNOFF POTENTIAL

- HYDROLOGIC GROUP D

TR-55 CN (DESERT SHRUB - POOR CONDITION)

CN = 88

$$R = 0.0132 \text{ CN} - 0.39 \quad (\text{EQN. 703})$$

$$R = 0.0132(88) - 0.39 = 0.77$$

PROJECT PV ESTATES PRO.# B068-16003

SUBJECT PRELIM HYDRO DATE 8-23-16

BY EUT SHEET 1 OF



Allen Gray & Associates INC.

CIVIL ENGINEERS • PROJECT & FACILITY DEVELOPMENT • CONSTRUCTION MANAGEMENT • SURVEYORS

130 Vine Street • Reno, Nevada 89503

(775) 329-2911 • Fax 329-6469

$$\text{LET } L_0 = 500'$$

$$S = \frac{4993.65 - 4915.78}{500} (100) = 15.57\%$$

$$t_{L_0} = \frac{1.8(1.1 - 0.77)(500)^{1/2}}{(15.57)^{1/3}} = 5.32 \text{ min}$$

SEGMENT 2 - UNCONCENTRATED OVERLAND FLOW

$$t_L = \frac{L}{60V}$$

WHERE: t_L = TRAVEL TIME (MIN)

L = OVERLAND FLOW LENGTH (FT)

V = VELOCITY (FPS)

USE FIGURE 701 - ALLUVIAL FANS WESTERN MOUNTAINS
REGIONS

$$L_2 = 775 \text{ FT}$$

$$S_2 = \frac{916 - 780}{775} (100) = 17.55\%$$

FROM FIG 701, $V = 4.25 \text{ fps}$

$$t_{L_2} = \frac{775}{(60)(4.25)} = 3.04 \text{ min}$$

PROJECT PV ESTATES PRO.# B0608-11003

SUBJECT PRELIM. HYDRO DATE 8-23-16

BY ECT SHEET 2 OF



Allen Gray & Associates INC.

CIVIL ENGINEERS • PROJECT & FACILITY DEVELOPMENT • CONSTRUCTION MANAGEMENT • SURVEYORS

130 Vine Street • Reno, Nevada 89503

(775) 329-2911 • Fax 329-6469

SEGMENT 3 - SHALLOW CONCENTRATED FLOW

MODEL AS V-DITCH

$$L = 917 \text{ FT}$$

$$S \approx \frac{780 - 740}{917} (100) = 4.36\%$$

APPROX. SIDE SLOPE = 3:1

$$n \approx 0.035$$

AT DEPTH = 0.25 FT, $V = 2.15 \text{ fps}$, $Q = 0.40 \text{ cfs}$

0.5 FT, $V = 3.41 \text{ fps}$, $Q = 2.55 \text{ cfs}$ ← MORE LIKELY

USE $V = 3.5 \text{ fps}$

$$t_{t3} = \frac{917 \text{ FT}}{(60 \text{ s/min})(3.5 \text{ fps})} = 4.37 \text{ min}$$

SEGMENT 4 - ON-SITE DITCH

MODEL AS TRAPEZOIDAL CHANNEL

BOTTOM WIDTH = 3 FT

SIDE SLOPE = 1.5:1

$$n = 0.08$$

$$L = 1330 \text{ FT}$$

$$S \approx \frac{739 - 716}{1330} = 1.73\%$$

AT $D = 0.5 \text{ FT}$, $V = 1.31 \text{ fps}$, $Q = 2.45 \text{ cfs}$

$D = 1.0 \text{ FT}$, $V = 1.90 \text{ fps}$, $Q = 8.53 \text{ cfs}$

$D = 1.5 \text{ FT}$, $V = 2.35 \text{ fps}$, $Q = 18.47 \text{ cfs}$

$D = 2.0 \text{ FT}$, $V = 2.73 \text{ fps}$, $Q = 32.74 \text{ cfs}$ ← MOST LIKELY

USE $V = 2.73 \text{ fps}$

$$t_{t4} = \frac{1330 \text{ FT}}{(60 \text{ s/min})(2.73 \text{ fps})} = 8.12 \text{ min}$$

$$t_c = t_u + \sum_{i=1}^4 t_i = 5.32 \text{ min} + 3.04 \text{ min} + 4.37 \text{ min} + 8.12 \text{ min} = 20.85 \text{ min}$$

PROJECT PV ESTATES PRO. # B008-10003

SUBJECT PRELIM HYDRO DATE 8-24-16

BY ELT SHEET 3 OF



Allen Gray & Associates INC.

CIVIL ENGINEERS • PROJECT & FACILITY DEVELOPMENT • CONSTRUCTION MANAGEMENT • SURVEYORS
130 Vine Street • Reno, Nevada 89503
(775) 329-2911 • Fax 329-6469

DETERMINING OVERALL RUNOFF COEFFICIENT FOR AREA E-1

THE TRUCKEE MEADOWS REGIONAL DRAINAGE MANUAL ONLY DEFINES ONE RUNOFF COEFFICIENT FOR RANGELAND. THERE IS NO ACKNOWLEDGEMENT OF THE EFFECT OF GROUND SLOPE OR GROUND COVER. THEREFORE THE CITY OF RENO'S PUBLIC WORKS DESIGN MANUAL HAS BEEN USED TO ESTIMATE 5-YEAR RUNOFF COEFFICIENTS.

THE NRCS SOIL SURVEY IDENTIFIES FIVE DIFFERENT SOIL TYPES PRESENT WITHIN AREA E-1 AND THREE DIFFERENT HYDROLOGIC SOIL GROUPS; A, C, AND D

TOTAL AREA E1 = 63.47 ac

AREA SOIL GROUP A = 13.78 ac - SLOPES < 15%

SOIL GROUP C = 3.20 ac - FLATTEST SLOPES

SOIL GROUP D = 46.49 ac - SLOPES > 15%

DETERMINING C & CN

FROM RENO PUBLIC WORKS DESIGN MANUAL:

OPEN SPACE (0-5% GRADE, VEGETATED) C = 0.2-0.3

OPEN SPACE (0-5% GRADE, NO VEGETATION) C = 0.3-0.4

OPEN SPACE (5-15% GRADE, VEGETATED OR UNVEGETATED) C = 0.4-0.5

OPEN SPACE (> 15% GRADE, SPARSELY VEGETATED, ROCK OR CLAY SOILS) C = 0.4-0.6

PROJECT PVESTARS PRO.# B068-16003

SUBJECT PRELIM HYDRO DATE 8-24-16

BY ELT SHEET 4 OF



Allen Gray & Associates INC.

CIVIL ENGINEERS • PROJECT & FACILITY DEVELOPMENT • CONSTRUCTION MANAGEMENT • SURVEYORS

130 Vine Street • Reno, Nevada 89503

(775) 329-2911 • Fax 329-6469

① HILLTOP AREA WEST OF BIG SMOKEY DRIVE:

< 30% GROUND COVER, SOIL GROUP D

A = 5.91 ac

VERY STEEP SLOPES

C = 0.60

CN = 85

② AREA EAST OF ROCKY VISTA, NORTH OF ROAD TO SS
BASINMENT

30-70% GROUND COVER, SOIL GROUP D

SLOPES MOSTLY > 15%

A = 13.31 ac

C = 0.55

CN = 70

③ AREA SOUTH OF ROAD TO SS BASINMENT

30-70% GROUND COVER (MORE DENSE THAN ABOVE),

SOIL GROUP D

SLOPES MOSTLY > 15%

A = 11.56 ac

C = 0.45

CN = 70

④ AREA WEST OF GROUP A SOILS (REMAINDER OF GROUP D)

CHARACTERISTICS ARE SAME AS ABOVE

A = 15.71 ac

C = 0.45

CN = 70

PROJECT PV ESTATOS PRO.# B068-16003

SUBJECT PRELIM HYDRO DATE 8-24-16

BY EJL SHEET 5 OF



Allen Gray & Associates INC.

CIVIL ENGINEERS • PROJECT & FACILITY DEVELOPMENT • CONSTRUCTION MANAGEMENT • SURVEYORS

130 Vine Street • Reno, Nevada 89503

(775) 329-2911 • Fax 329-6469

- ⑤ AREA ON WEST EDGE OF GROUP A SOILS, STEEP SLOPES
30-70% GROUND COVER SAME AS ③
SLOPES MOSTLY < 15%

$$A = 1.92ac$$

$$C = 0.40$$

CN = 63 → TR-55 DOES NOT RECOGNIZE SOIL GROUP A
IN SAGEBRUSH CATEGORY ∴ USE DESERT
SHRUB CATEGORY

- ⑥ CLEARED AREA AT EX. HOUSE IN SOIL GROUP A
0-5% SLOPES, NO VEGETATION - TYPE A SOIL

$$A = 1.50ac$$

$$C = 0.3$$

$$CN = 63 \text{ (SEE ⑤)}$$

- ⑦ REMAINDER OF GROUP A SOILS

0-5% SLOPES,

30-70% GROUND COVER (MORE THAN ③)

$$A = 10.36ac$$

$$C = 0.25$$

CN = 55 → SEE ⑤, FAIR CONDITION

- ⑧ CLEARED AREA AT HOUSE IN SOIL GROUP C
0-5% SLOPES, NO VEGETATION

$$A = 1.30ac$$

$$C = 0.30$$

$$CN = 80$$

PROJECT PV ESTATES PRO. # 15068-16008

SUBJECT PRELIM HYDRO DATE 8-24-16

BY ECT SHEET 6 OF



Allen Gray & Associates INC.

CIVIL ENGINEERS • PROJECT & FACILITY DEVELOPMENT • CONSTRUCTION MANAGEMENT • SURVEYORS
130 Vine Street • Reno, Nevada 89503
(775) 329-2911 • Fax 329-6469

⑨ REMAINDER OF GROUP C SOILS
SLOPES < 5% GOOD VEGETATION (> 70%)

$$A = 1.9$$

$$C = 0.20$$

$$CN = 47$$

COMPOSITE C_5

$$(0.6)(5.91) + (13.31)(0.55) + (0.45)(11.56) + (0.45)(15.71) \\ + (0.40)(1.92) + (0.30)(1.50) + (0.25)(10.36) \\ + (0.30)(1.30) + (0.20)(1.90)$$

$$63.47 \text{ ac}$$

$$C = 0.44$$

$$\text{COMPOSITE } CN = (85)(5.91) + (70)(13.31) + (70)(11.56) \\ + (70)(15.71) + (63)(1.92) + (55)(10.36) \\ + (80)(1.30) + (47)(1.9) + (63)(1.50)$$

$$63.47 \text{ ac}$$

$$CN = 68$$

THE TRUCKEE MEADOWS REGIONAL DRAINAGE MANUAL MAKES A DISTINCTION BETWEEN THE RUNOFF COEFFICIENT FOR THE 5 AND 100-YEAR STORMS. FOR UNDEVELOPED RANGE LAND $C_5 = 0.20$, AND $C_{100} = 0.50$. THIS IS A LARGE RANGE. IF THE SAME RATIO WERE APPLIED TO THE COMPUTED RUNOFF COEFFICIENT ABOVE, C_{100} WOULD BE GREATER THAN 1.0, WHICH IS IMPOSSIBLE.

SINCE A HIGHER 5-YEAR RUNOFF COEFFICIENT WAS USED, THE RATIO OF 100 TO 5-YEAR SHOULD BE LESS. THEREFORE, USE $C_{100} = 0.66$, REPRESENTING A 50% INCREASE

PROJECT TN ESTATES PRO. # BD068-16003

SUBJECT PRELIM HYDRO DATE 8-24-16

BY BCT

SHEET 7 OF



Allen Gray & Associates INC.

CIVIL ENGINEERS • PROJECT & FACILITY DEVELOPMENT • CONSTRUCTION MANAGEMENT • SURVEYORS

130 Vine Street • Reno, Nevada 89503

(775) 329-2911 • Fax 329-6469

RAINFALL INTENSITY / PRECIPITATION

FROM NOAA ATLAS 14

$$T_c = 20.85 \text{ min}$$

$$P_s = 0.36 \text{ in}$$

$$P_{100} = 0.87 \text{ in}$$

$$i_s = 1.10 \text{ in/hr}$$

$$i_{100} = 2.66 \text{ in/hr}$$

SUMMARY FOR AREA E-1

$$A = 63.47 \text{ ac} = 0.099 \text{ mi}^2$$

$$T_c = 20.85 \text{ min} = 0.35 \text{ hr}$$

$$T_L = 0.6 (T_c) = 12.51 \text{ min} = 0.21 \text{ hr}$$

$$C_s = 0.44$$

$$C_{100} = 0.66$$

$$CN = 68$$

$$P_s = 0.36 \text{ in}$$

$$P_{100} = 0.87 \text{ in}$$

$$i_s = 1.10 \text{ in/hr}$$

$$i_{100} = 2.66 \text{ in/hr}$$

IMPERVIOUS AREA

$$\text{ROAD} \approx 2100 \text{ SF}$$

$$\text{BUILDING} \approx 40,950 \text{ SF}$$

$$\text{TOTAL} = 43,050 \text{ SF} = 0.99 \text{ ac} = 1.56\%$$

PROJECT PV ESTATOS PRO. # B068-16003

SUBJECT PRELIM HYDRO DATE 8-21-16

BY ELT SHEET 8 OF



Allen Gray & Associates INC.

CIVIL ENGINEERS • PROJECT & FACILITY DEVELOPMENT • CONSTRUCTION MANAGEMENT • SURVEYORS
130 Vine Street • Reno, Nevada 89503
(775) 329-2911 • Fax 329-6469

AREA E2 - NORTHEAST CORNER OF PROPERTY
DRAINING TO EAST, OFFSITE

$$A = 12,875 \text{ SF} = 0.30 \text{ ac}$$

CHARACTERISTICS ARE SIMILAR TO ② IN E1

$$C_5 = 0.55 \quad \text{SOIL GROUP D}$$

$$C_{100} = 0.80$$

$$CN = 70$$

BY OBSERVATION: $t_L = 10 \text{ min} = 0.17 \text{ hr}$

$$t_L = 6 \text{ min} = 0.10 \text{ hr}$$

$$P_5 = 0.36 \text{ in}$$

$$P_{100} = 0.87 \text{ in}$$

$$i_5 = 1.10 \text{ in/hr}$$

$$i_{100} = 2.66 \text{ in/hr}$$

NO IMPERVIOUS AREA

AREA E3 - SOUTHEAST CORNER OF PROPERTY
DRAINING TO EAST, OFFSITE

$$A = 10,386 \text{ SF} = 0.24 \text{ ac}$$

CHARACTERISTICS ARE SAME AS ③ IN E1

$$C_5 = 0.45 \quad \text{SOIL GROUP D}$$

$$C_{100} = 0.65$$

$$CN = 70$$

BY OBSERVATION: $t_L = 10 \text{ min} = 0.17 \text{ hr}$

$$t_L = 6 \text{ min} = 0.10 \text{ hr}$$

$$P_5 = 0.36 \text{ in}$$

$$P_{100} = 0.87 \text{ in}$$

$$i_5 = 1.10 \text{ in/hr}$$

$$i_{100} = 2.66 \text{ in/hr}$$

NO IMPERVIOUS AREA

PROJECT PV ESTATES PRO. # B06B-16003

SUBJECT Provision Hydro DATE 8-24-16

BY ECT SHEET 9 OF



Allen Gray & Associates INC.

CIVIL ENGINEERS • PROJECT & FACILITY DEVELOPMENT • CONSTRUCTION MANAGEMENT • SURVEYORS

130 Vine Street • Reno, Nevada 89503

(775) 329-2911 • Fax 329-6469

AREA EA - SOUTH CENTRAL - DRAINS OFFSITE

$$A = 31,961 \text{ SF} = 0.73 \text{ ac}$$

SOIL GROUP A, 5-15% GRADE, GOOD VEGETATION

$$A = 0.35 \text{ ac}$$

$$C_s = 0.40$$

$$C_{100} = 0.60$$

$$CN = 55$$

$$\frac{T_c = 10 \text{ min}}{T_L = 6 \text{ min}}$$

SEE EB FOR P & i

SOIL GROUP C, < 5% GRADE, GOOD VEGETATION

$$A = 0.38 \text{ ac}$$

$$C_s = 0.30$$

$$C_{100} = 0.45$$

$$CN = 47$$

BY OBSERVATION $T_c = 10 \text{ min}$, $T_L = 6 \text{ min}$

SEE EB FOR P & i

$$\text{COMPOSITE } C_s = \frac{(0.35)(0.40) + (0.38)(0.30)}{0.73}$$

$$C_s = 0.35$$

$$\text{COMPOSITE } C_{100} = \frac{(0.35)(0.60) + (0.38)(0.45)}{0.73}$$

$$C_{100} = 0.52$$

$$\text{COMPOSITE } CN = \frac{(0.35)(55) + (0.38)(47)}{0.73}$$

$$CN = 51$$

NO IMPERVIOUS AREA

PROJECT PV ESTATES PRO.# B068-16003

SUBJECT PRELIM HAPPS DATE 8-24-16

BY ELT SHEET 10 OF



Allen Gray & Associates INC.

CIVIL ENGINEERS • PROJECT & FACILITY DEVELOPMENT • CONSTRUCTION MANAGEMENT • SURVEYORS
130 Vine Street • Reno, Nevada 89503
(775) 329-2911 • Fax 329-6469

AREA E5 - SOUTHWEST CORNER - DRAINS OFFSITE

$$A = 28,743 \text{ SF} = 0.66 \text{ ac}$$

SOIL GROUP D - 5-15% GRADE, MODERATE VEGETATION

SIMILAR TO E1, (3)

$$A = 0.49 \text{ ac}$$

$$C_s = 0.45$$

$$C_{100} = 0.68$$

$$CN = 70$$

SOIL GROUP A 5-15% GRADE, MODERATE VEGETATION

SIMILAR TO E1 (3)

$$A = 0.17 \text{ ac}$$

$$C_s = 0.40$$

$$C_{100} = 0.55$$

$$CN = 63$$

$$\text{COMPOSITE } C_s = \frac{(0.49)(0.45) + (0.17)(0.40)}{(0.49 + 0.17)} = 0.44$$

$$C_{100} = \frac{(0.49)(0.68) + (0.17)(0.55)}{(0.49 + 0.17)} = 0.65$$

$$CN = \frac{(0.49)(70) + (0.17)(63)}{(0.49 + 0.17)} = 68$$

BY OBSERVATION, $T_C = 10 \text{ min} = 0.17 \text{ hr}$

$T_L = 6 \text{ min} = 0.10 \text{ hr}$

NO IMPERVIOUS AREA

SEE E3 FOR PRECIP & INTENSITY

PROJECT DV ESTATES PRO. # P5068-16003

SUBJECT PRELIM HYDRO DATE 8-25-16

BY ELT SHEET 11 OF



Allen Gray & Associates INC.

CIVIL ENGINEERS • PROJECT & FACILITY DEVELOPMENT • CONSTRUCTION MANAGEMENT • SURVEYORS

130 Vine Street • Reno, Nevada 89503

(775) 329-2911 • Fax 329-6469

Proposed Hydrology

Area P1 - Area Contributing to 24" Culvert
at South Property Boundary.

TOTAL AREA = 2,887,521 SF = 66.29 ac = 0.10 sq. mi.

T_C, T_L DO NOT CHANGE FROM EXISTING

$$\therefore T_C = 20.85 \text{ min} = 0.35 \text{ hr}$$

$$T_L = 12.51 \text{ min} = 0.21 \text{ hr}$$

INCREASE IN OVERALL AREA DUE TO STREETS.

- CONTRIBUTING AREAS THAT ARE CHANGED
ARE IN SOUTHERN PORTION OF SITE ONLY

Area ① - SEE EXISTING ①

② - SEE EXISTING ②

③ - SEE EXISTING ③ + EXTRA = 11.56 + 0.03 = 11.59

④ - AREA EXISTING ④ + EXTRA AREA

$$\text{EXTRA AREA} = 79,761 \text{ SF} = 1.83 \text{ ac}$$

$$\text{TOTAL AREA} = 15.71 \text{ ac} + 1.83 \text{ ac} = 17.54 \text{ ac}$$

$$C = 0.45$$

$$CN = 70$$

⑤ - SEE EXISTING ⑤

⑥ - SEE EXISTING ⑥

PROJECT PV ESTATOS PRO. # B068-16003

SUBJECT Prelim Hydro DATE 9-12-16

BY ELT

SHEET 12 OF



Allen Gray & Associates INC.

CIVIL ENGINEERS • PROJECT & FACILITY DEVELOPMENT • CONSTRUCTION MANAGEMENT • SURVEYORS

130 Vine Street • Reno, Nevada 89503

(775) 329-2911 • Fax 329-6469

⑦ - AREA EXISTING ⑦ + EXTRA AREA

$$\text{EXTRA AREA} = 25,244 \text{ SF} = 0.58 \text{ ac}$$

$$\text{TOTAL AREA} = 10.36 \text{ ac} + 0.58 \text{ ac} = 10.94 \text{ ac}$$

$$C = 0.25$$

$$CN = 55$$

⑧ - ~~SEE~~ EXISTING 8

⑨ - AREA EXISTING ⑨ + EXTRA AREA

$$\text{EXTRA AREA} = 0.38 \text{ ac}$$

$$\text{TOTAL AREA} = 1.9 \text{ ac} + 0.38 \text{ ac} = 2.28 \text{ ac}$$

$$C = 0.20$$

$$CN = 47$$

$$\begin{aligned} \text{COMPOSITE } C_s &= (0.6)(5.91) + (0.55)(13.31) + (0.45)(11.59) \\ &+ (0.45)(17.54) + (0.40)(1.92) + (0.30)(1.50) \\ &+ (0.25)(10.94) + (0.30)(1.30) + (0.20)(2.28) \\ &\hline &66.29 \text{ ac} \end{aligned}$$

$$C = 0.43$$

$$\begin{aligned} \text{COMPOSITE } CN &= (85)(5.91) + (70)(13.31) + (70)(11.59) \\ &+ (70)(17.54) + (63)(1.92) + (63)(1.50) \\ &+ (55)(10.94) + (80)(1.30) + (47)(2.28) \\ &\hline &66.29 \text{ ac} \end{aligned}$$

$$CN = 68$$

$$\text{LET } C_{100} = 0.65$$

PROJECT FV ESTATOS PRO. # F068-16003

SUBJECT PRELIM HYDRO DATE 9-12-16

BY ELT SHEET 13 OF



Allen Gray & Associates INC.

CIVIL ENGINEERS • PROJECT & FACILITY DEVELOPMENT • CONSTRUCTION MANAGEMENT • SURVEYORS

130 Vine Street • Reno, Nevada 89503

(775) 329-2911 • Fax 329-6469

IMPERVIOUS AREA

- ASSUME: ① TYPICAL HOUSE 60' X 60' = 3600 SF FOOTPRINT
② TYPICAL DRIVEWAY 24' X 40' = 960 SF
③ GRAVEL SITE FOR LIFT STATION

$$\text{TOTAL IMPERVIOUS/LOT} = 4560 \text{ SF} \\ \text{--- ROUND TO } 5000 \text{ SF}$$

$$(54 \text{ LOTS})(5000 \text{ SF/LOT}) = 270,000 \text{ SF} = 6.20 \text{ ac}$$

$$\text{STREET/SIDWALK AREA} = 196,882 \text{ SF} = 4.52 \text{ ac}$$

$$\text{EXISTING IMPERVIOUS AREA} = 43,050 \text{ SF} = 0.99 \text{ ac}$$

$$\text{TOTAL IMPERVIOUS} = 270,000 \text{ SF} + 196,882 \text{ SF} + 43,050 \text{ SF} \\ = 509,932 \text{ SF} = 11.71 \text{ ac}$$

$$\% \text{ OF TOTAL} = \frac{509,932}{2,887,521} = 17.66\%$$

SUMMARY: COMPOSITE CN = 68
% IMPERVIOUS = 17.66
TOTAL AREA = 66.29 ac = 0.10 sq mi
Tc = 20.85 min = 0.35 hr
TL = 12.51 min = 0.21 hr

PROJECT PV ESTADOS PRO. # B068-10003

SUBJECT PRELIM HYDRO DATE 9-14-16

BY ELT SHEET 14 OF



Allen Gray & Associates INC.

CIVIL ENGINEERS • PROJECT & FACILITY DEVELOPMENT • CONSTRUCTION MANAGEMENT • SURVEYORS
130 Vine Street • Reno, Nevada 89503
(775) 329-2911 • Fax 329-6469

ROUGH DETENTION CALCULATION

EXISTING CONDITIONS:

$$Q_5 = 1.9 \text{ cfs}$$

$$H_5 = 0.20 \text{ ac.ft}$$

$$Q_{100} = 9.2 \text{ cfs}$$

$$H_{100} = 0.80 \text{ ac.ft}$$

PROPOSED CONDITIONS:

$$Q_5 = 5.2 \text{ cfs}$$

$$H_5 = 0.5 \text{ ac.ft}$$

$$Q_{100} = 16.4 \text{ cfs}$$

$$H_{100} = 1.4 \text{ ac.ft}$$

REQUIRED STORAGE VOLUME (MIN.)

$$H_5 = 0.5 \text{ ac.ft} - 0.2 \text{ ac.ft} = 0.30 \text{ ac.ft}$$

$$H_{100} = 1.4 \text{ ac.ft} - 0.80 \text{ ac.ft} = 0.60 \text{ ac.ft}$$

USE A SAFETY FACTOR OF 50%

$$\therefore \text{REQUIRED STORAGE} = (0.60)(1.5) = 0.9 \text{ ac.ft}$$
$$= 39,204 \text{ cu.ft}$$

$$\text{IF } D = 2 \text{ FT, THEN } A = 19,602 \text{ SF (140' SQUARE)}$$

$$\text{AVAILABLE VOLUME AT OVERFLOW} = 38,907 \text{ cf OK}$$

(38%) SF

PROJECT CHANCELANE PRO. # B069-16003

SUBJECT Hydrology DATE _____

BY ELT SHEET 1 OF 1



Allen Gray & Associates INC.

CIVIL ENGINEERS • PROJECT & FACILITY DEVELOPMENT • CONSTRUCTION MANAGEMENT • SURVEYORS
130 Vine Street • Reno, Nevada 89503
(775) 329-2911 • Fax 329-6469

5-year Storm Run Results – Existing Conditions

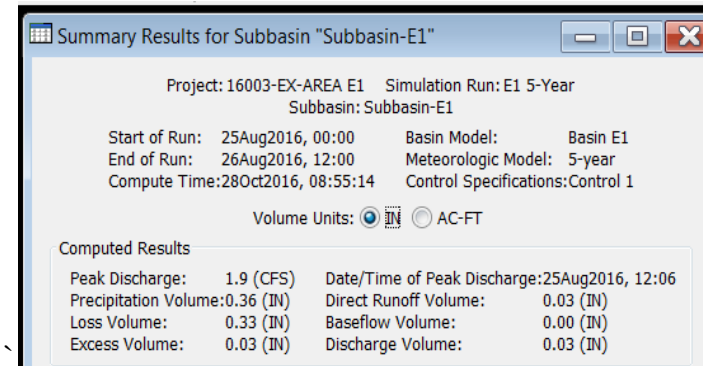
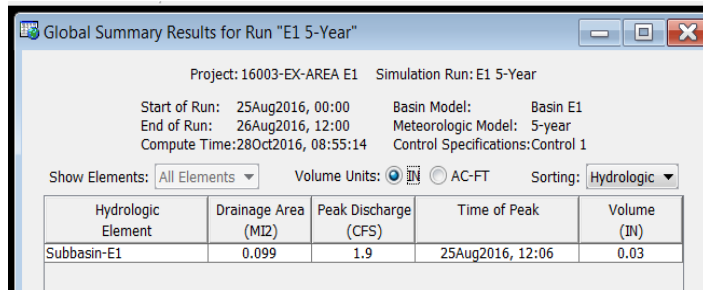
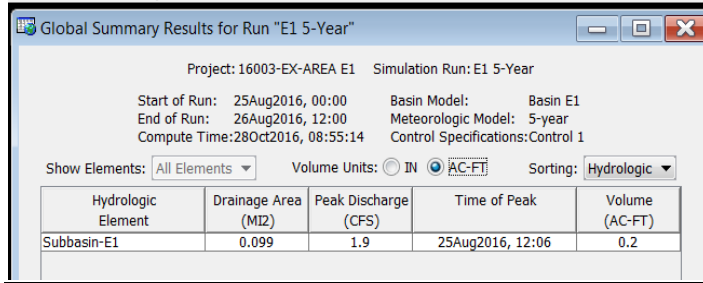

Time-Series Results for Subbasin "Subbasin-E1"

Project: 16003-EX-AREA E1 Simulation Run: E1 5-Year
 Subbasin: Subbasin-E1

Start of Run: 25Aug2016, 00:00 Basin Model: Basin E1
 End of Run: 26Aug2016, 12:00 Meteorologic Model: 5-year
 Compute Time:28Oct2016, 08:55:14 Control Specifications:Control 1

Date	Time	Precip (IN)	Loss (IN)	Excess (IN)	Direct Flow (CFS)	Baseflow (CFS)	Total Flow (CFS)
25Aug2016	11:53	0.01	0.01	0.00	0.7	0.0	0.7
25Aug2016	11:54	0.01	0.01	0.00	0.8	0.0	0.8
25Aug2016	11:55	0.01	0.01	0.00	0.9	0.0	0.9
25Aug2016	11:56	0.01	0.01	0.00	1.0	0.0	1.0
25Aug2016	11:57	0.01	0.01	0.00	1.1	0.0	1.1
25Aug2016	11:58	0.01	0.00	0.00	1.3	0.0	1.3
25Aug2016	11:59	0.00	0.00	0.00	1.4	0.0	1.4
25Aug2016	12:00	0.00	0.00	0.00	1.5	0.0	1.5
25Aug2016	12:01	0.00	0.00	0.00	1.6	0.0	1.6
25Aug2016	12:02	0.00	0.00	0.00	1.7	0.0	1.7
25Aug2016	12:03	0.00	0.00	0.00	1.8	0.0	1.8
25Aug2016	12:04	0.00	0.00	0.00	1.8	0.0	1.8
25Aug2016	12:05	0.00	0.00	0.00	1.9	0.0	1.9
25Aug2016	12:06	0.00	0.00	0.00	1.9	0.0	1.9
25Aug2016	12:07	0.00	0.00	0.00	1.9	0.0	1.9
25Aug2016	12:08	0.00	0.00	0.00	1.8	0.0	1.8
25Aug2016	12:09	0.00	0.00	0.00	1.8	0.0	1.8
25Aug2016	12:10	0.00	0.00	0.00	1.7	0.0	1.7
25Aug2016	12:11	0.00	0.00	0.00	1.6	0.0	1.6
25Aug2016	12:12	0.00	0.00	0.00	1.5	0.0	1.5
25Aug2016	12:13	0.00	0.00	0.00	1.4	0.0	1.4
25Aug2016	12:14	0.00	0.00	0.00	1.3	0.0	1.3
25Aug2016	12:15	0.00	0.00	0.00	1.2	0.0	1.2
25Aug2016	12:16	0.00	0.00	0.00	1.1	0.0	1.1
25Aug2016	12:17	0.00	0.00	0.00	1.0	0.0	1.0
25Aug2016	12:18	0.00	0.00	0.00	1.0	0.0	1.0
25Aug2016	12:19	0.00	0.00	0.00	0.9	0.0	0.9
25Aug2016	12:20	0.00	0.00	0.00	0.8	0.0	0.8
25Aug2016	12:21	0.00	0.00	0.00	0.8	0.0	0.8

100-year Storm Run Results – Existing Conditions

Global Summary Results for Run "E1 100-year"

Project: 16003-EX-AREA E1 Simulation Run: E1 100-year

Start of Run: 25Aug2016, 00:00 Basin Model: Basin E1
 End of Run: 26Aug2016, 12:00 Meteorologic Model: 100-year
 Compute Time: 28Oct2016, 09:04:50 Control Specifications: Control 1

Show Elements: All Elements Volume Units: IN AC-FT Sorting: Hydrologic

Hydrologic Element	Drainage Area (MI ²)	Peak Discharge (CFS)	Time of Peak	Volume (IN)
Subbasin-E1	0.099	9.2	25Aug2016, 12:06	0.15

Global Summary Results for Run "E1 100-year"

Project: 16003-EX-AREA E1 Simulation Run: E1 100-year

Start of Run: 25Aug2016, 00:00 Basin Model: Basin E1
 End of Run: 26Aug2016, 12:00 Meteorologic Model: 100-year
 Compute Time: 28Oct2016, 09:04:50 Control Specifications: Control 1

Show Elements: All Elements Volume Units: IN AC-FT Sorting: Hydrologic

Hydrologic Element	Drainage Area (MI ²)	Peak Discharge (CFS)	Time of Peak	Volume (AC-FT)
Subbasin-E1	0.099	9.2	25Aug2016, 12:06	0.8

Summary Results for Subbasin "Subbasin-E1"

Project: 16003-EX-AREA E1 Simulation Run: E1 100-year
 Subbasin: Subbasin-E1

Start of Run: 25Aug2016, 00:00 Basin Model: Basin E1
 End of Run: 26Aug2016, 12:00 Meteorologic Model: 100-year
 Compute Time: 28Oct2016, 09:04:50 Control Specifications: Control 1

Volume Units: IN AC-FT

Computed Results

Peak Discharge:	9.2 (CFS)	Date/Time of Peak Discharge:	25Aug2016, 12:06
Precipitation Volume:	0.87 (IN)	Direct Runoff Volume:	0.15 (IN)
Loss Volume:	0.72 (IN)	Baseflow Volume:	0.00 (IN)
Excess Volume:	0.15 (IN)	Discharge Volume:	0.15 (IN)

5-year Storm Run Results – Proposed Conditions

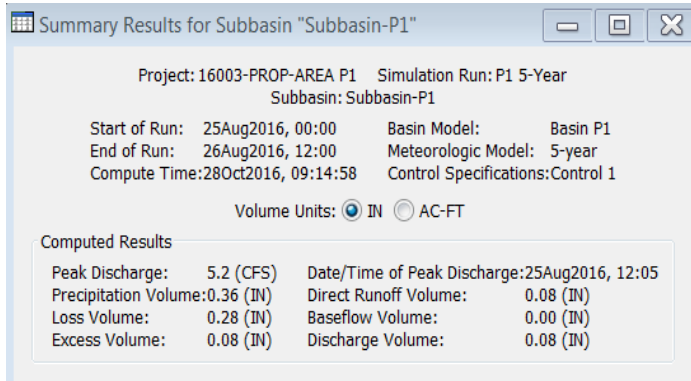
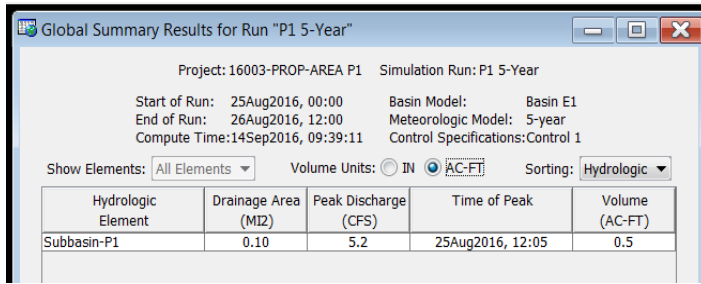
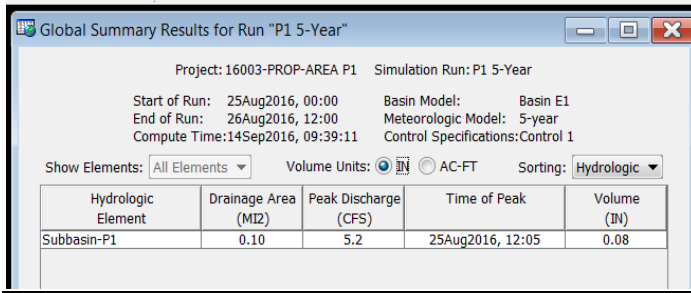

Time-Series Results for Subbasin "Subbasin-P1"

Project: 16003-PROP-AREA P1 Simulation Run: P1 5-Year
Subbasin: Subbasin-P1

Start of Run: 25Aug2016, 00:00 Basin Model: Basin E1
End of Run: 26Aug2016, 12:00 Meteorologic Model: 5-year
Compute Time: 14Sep2016, 09:39:11 Control Specifications: Control 1

Date	Time	Precip (IN)	Loss (IN)	Excess (IN)	Direct Flow (CFS)	Baseflow (CFS)	Total Flow (CFS)
25Aug2016	11:55	0.01	0.01	0.00	2.9	0.0	2.9
25Aug2016	11:56	0.01	0.01	0.00	3.2	0.0	3.2
25Aug2016	11:57	0.01	0.00	0.00	3.5	0.0	3.5
25Aug2016	11:58	0.01	0.00	0.00	3.8	0.0	3.8
25Aug2016	11:59	0.00	0.00	0.00	4.1	0.0	4.1
25Aug2016	12:00	0.00	0.00	0.00	4.4	0.0	4.4
25Aug2016	12:01	0.00	0.00	0.00	4.6	0.0	4.6
25Aug2016	12:02	0.00	0.00	0.00	4.9	0.0	4.9
25Aug2016	12:03	0.00	0.00	0.00	5.0	0.0	5.0
25Aug2016	12:04	0.00	0.00	0.00	5.1	0.0	5.1
25Aug2016	12:05	0.00	0.00	0.00	5.2	0.0	5.2
25Aug2016	12:06	0.00	0.00	0.00	5.2	0.0	5.2
25Aug2016	12:07	0.00	0.00	0.00	5.1	0.0	5.1
25Aug2016	12:08	0.00	0.00	0.00	4.9	0.0	4.9
25Aug2016	12:09	0.00	0.00	0.00	4.7	0.0	4.7
25Aug2016	12:10	0.00	0.00	0.00	4.5	0.0	4.5
25Aug2016	12:11	0.00	0.00	0.00	4.3	0.0	4.3
25Aug2016	12:12	0.00	0.00	0.00	4.0	0.0	4.0
25Aug2016	12:13	0.00	0.00	0.00	3.7	0.0	3.7
25Aug2016	12:14	0.00	0.00	0.00	3.4	0.0	3.4
25Aug2016	12:15	0.00	0.00	0.00	3.1	0.0	3.1
25Aug2016	12:16	0.00	0.00	0.00	2.9	0.0	2.9
25Aug2016	12:17	0.00	0.00	0.00	2.7	0.0	2.7
25Aug2016	12:18	0.00	0.00	0.00	2.5	0.0	2.5
25Aug2016	12:19	0.00	0.00	0.00	2.3	0.0	2.3
25Aug2016	12:20	0.00	0.00	0.00	2.1	0.0	2.1
25Aug2016	12:21	0.00	0.00	0.00	2.0	0.0	2.0
25Aug2016	12:22	0.00	0.00	0.00	1.8	0.0	1.8
25Aug2016	12:23	0.00	0.00	0.00	1.7	0.0	1.7

100-year Storm Run Results

Global Summary Results for Run "P1 100-year"

Project: 16003-PROP-AREA P1 Simulation Run: P1 100-year

Start of Run: 25Aug2016, 00:00 Basin Model: Basin E1
 End of Run: 26Aug2016, 12:00 Meteorologic Model: 100-year
 Compute Time: 14Sep2016, 09:38:30 Control Specifications: Control 1

Show Elements: All Elements Volume Units: IN AC-FT Sorting: Hydrologic

Hydrologic Element	Drainage Area (MI ²)	Peak Discharge (CFS)	Time of Peak	Volume (IN)
Subbasin-P1	0.10	16.4	25Aug2016, 12:05	0.27

Global Summary Results for Run "P1 100-year"

Project: 16003-PROP-AREA P1 Simulation Run: P1 100-year

Start of Run: 25Aug2016, 00:00 Basin Model: Basin E1
 End of Run: 26Aug2016, 12:00 Meteorologic Model: 100-year
 Compute Time: 14Sep2016, 09:38:30 Control Specifications: Control 1

Show Elements: All Elements Volume Units: IN AC-FT Sorting: Hydrologic

Hydrologic Element	Drainage Area (MI ²)	Peak Discharge (CFS)	Time of Peak	Volume (AC-FT)
Subbasin-P1	0.10	16.4	25Aug2016, 12:05	1.4

Summary Results for Subbasin "Subbasin-P1"

Project: 16003-PROP-AREA P1 Simulation Run: P1 100-year
 Subbasin: Subbasin-P1

Start of Run: 25Aug2016, 00:00 Basin Model: Basin P1
 End of Run: 26Aug2016, 12:00 Meteorologic Model: 100-year
 Compute Time: 14Sep2016, 10:24:27 Control Specifications: Control 1

Volume Units: IN AC-FT

Computed Results

Peak Discharge: 16.4 (CFS)	Date/Time of Peak Discharge: 25Aug2016, 12:05
Precipitation Volume: 0.87 (IN)	Direct Runoff Volume: 0.27 (IN)
Loss Volume: 0.60 (IN)	Baseflow Volume: 0.00 (IN)
Excess Volume: 0.27 (IN)	Discharge Volume: 0.27 (IN)

Time-Series Results for Subbasin "Subbasin-P1"

Project: 16003-PROP-AREA P1 Simulation Run: P1 100-year
Subbasin: Subbasin-P1

Start of Run: 25Aug2016, 00:00 Basin Model: Basin E1
End of Run: 26Aug2016, 12:00 Meteorologic Model: 100-year
Compute Time: 14Sep2016, 09:38:30 Control Specifications: Control 1

Date	Time	Precip (IN)	Loss (IN)	Excess (IN)	Direct Flow (CFS)	Baseflow (CFS)	Total Flow (CFS)
25Aug2016	11:55	0.02	0.01	0.01	8.8	0.0	8.8
25Aug2016	11:56	0.02	0.01	0.01	9.7	0.0	9.7
25Aug2016	11:57	0.01	0.01	0.01	10.7	0.0	10.7
25Aug2016	11:58	0.01	0.01	0.00	11.7	0.0	11.7
25Aug2016	11:59	0.01	0.01	0.00	12.7	0.0	12.7
25Aug2016	12:00	0.01	0.01	0.00	13.7	0.0	13.7
25Aug2016	12:01	0.01	0.00	0.00	14.5	0.0	14.5
25Aug2016	12:02	0.00	0.00	0.00	15.3	0.0	15.3
25Aug2016	12:03	0.00	0.00	0.00	15.8	0.0	15.8
25Aug2016	12:04	0.00	0.00	0.00	16.2	0.0	16.2
25Aug2016	12:05	0.00	0.00	0.00	16.4	0.0	16.4
25Aug2016	12:06	0.00	0.00	0.00	16.4	0.0	16.4
25Aug2016	12:07	0.00	0.00	0.00	16.2	0.0	16.2
25Aug2016	12:08	0.00	0.00	0.00	15.8	0.0	15.8
25Aug2016	12:09	0.00	0.00	0.00	15.2	0.0	15.2
25Aug2016	12:10	0.00	0.00	0.00	14.5	0.0	14.5
25Aug2016	12:11	0.00	0.00	0.00	13.6	0.0	13.6
25Aug2016	12:12	0.00	0.00	0.00	12.8	0.0	12.8
25Aug2016	12:13	0.00	0.00	0.00	11.9	0.0	11.9
25Aug2016	12:14	0.00	0.00	0.00	11.0	0.0	11.0
25Aug2016	12:15	0.00	0.00	0.00	10.2	0.0	10.2
25Aug2016	12:16	0.00	0.00	0.00	9.4	0.0	9.4
25Aug2016	12:17	0.00	0.00	0.00	8.6	0.0	8.6
25Aug2016	12:18	0.00	0.00	0.00	8.0	0.0	8.0
25Aug2016	12:19	0.00	0.00	0.00	7.4	0.0	7.4
25Aug2016	12:20	0.00	0.00	0.00	6.9	0.0	6.9
25Aug2016	12:21	0.00	0.00	0.00	6.4	0.0	6.4
25Aug2016	12:22	0.00	0.00	0.00	6.0	0.0	6.0
25Aug2016	12:23	0.00	0.00	0.00	5.6	0.0	5.6

Time-Series Results for Subbasin "Subbasin-E1"

Project: 16003-EX-AREA E1 Simulation Run: E1 100-year
Subbasin: Subbasin-E1

Start of Run: 25Aug2016, 00:00 Basin Model: Basin E1
End of Run: 26Aug2016, 12:00 Meteorologic Model: 100-year
Compute Time: 28Oct2016, 09:04:50 Control Specifications: Control 1

Date	Time	Precip (IN)	Loss (IN)	Excess (IN)	Direct Flow (CFS)	Baseflow (CFS)	Total Flow (CFS)
25Aug2016	11:53	0.02	0.02	0.00	3.4	0.0	3.4
25Aug2016	11:54	0.02	0.02	0.00	3.9	0.0	3.9
25Aug2016	11:55	0.02	0.01	0.00	4.4	0.0	4.4
25Aug2016	11:56	0.02	0.01	0.00	4.9	0.0	4.9
25Aug2016	11:57	0.01	0.01	0.00	5.5	0.0	5.5
25Aug2016	11:58	0.01	0.01	0.00	6.1	0.0	6.1
25Aug2016	11:59	0.01	0.01	0.00	6.7	0.0	6.7
25Aug2016	12:00	0.01	0.01	0.00	7.3	0.0	7.3
25Aug2016	12:01	0.01	0.00	0.00	7.8	0.0	7.8
25Aug2016	12:02	0.00	0.00	0.00	8.3	0.0	8.3
25Aug2016	12:03	0.00	0.00	0.00	8.7	0.0	8.7
25Aug2016	12:04	0.00	0.00	0.00	9.0	0.0	9.0
25Aug2016	12:05	0.00	0.00	0.00	9.2	0.0	9.2
25Aug2016	12:06	0.00	0.00	0.00	9.2	0.0	9.2
25Aug2016	12:07	0.00	0.00	0.00	9.2	0.0	9.2
25Aug2016	12:08	0.00	0.00	0.00	9.0	0.0	9.0
25Aug2016	12:09	0.00	0.00	0.00	8.7	0.0	8.7
25Aug2016	12:10	0.00	0.00	0.00	8.3	0.0	8.3
25Aug2016	12:11	0.00	0.00	0.00	7.9	0.0	7.9
25Aug2016	12:12	0.00	0.00	0.00	7.4	0.0	7.4
25Aug2016	12:13	0.00	0.00	0.00	6.9	0.0	6.9
25Aug2016	12:14	0.00	0.00	0.00	6.4	0.0	6.4
25Aug2016	12:15	0.00	0.00	0.00	6.0	0.0	6.0
25Aug2016	12:16	0.00	0.00	0.00	5.5	0.0	5.5
25Aug2016	12:17	0.00	0.00	0.00	5.1	0.0	5.1
25Aug2016	12:18	0.00	0.00	0.00	4.7	0.0	4.7
25Aug2016	12:19	0.00	0.00	0.00	4.4	0.0	4.4
25Aug2016	12:20	0.00	0.00	0.00	4.1	0.0	4.1
25Aug2016	12:21	0.00	0.00	0.00	3.8	0.0	3.8

APPENDIX D

FIGURES

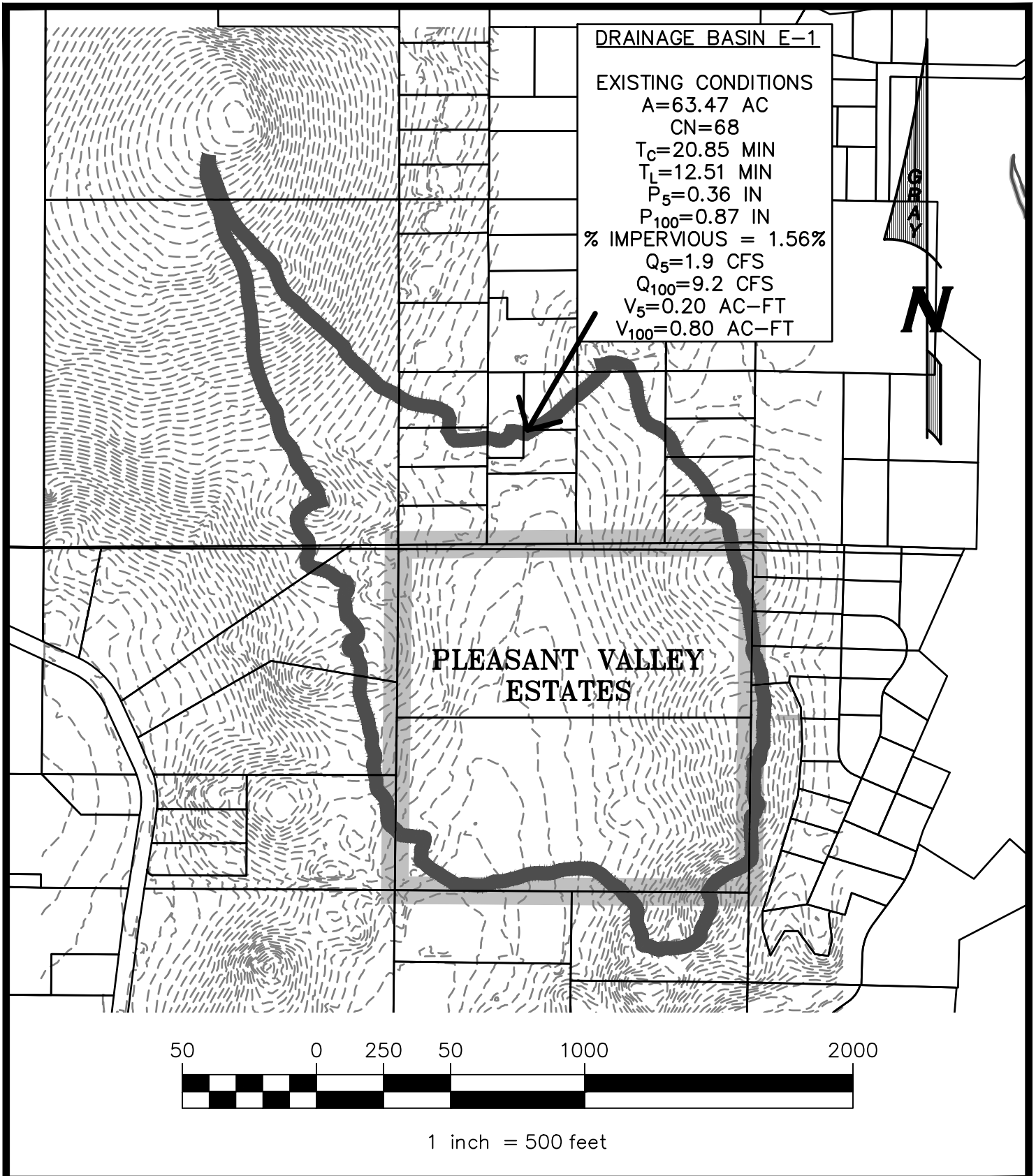

PLEASANT VALLEY ESTATES
 TENTATIVE MAP
 EXISTING DRAINAGE AREAS

SCALE: 1"=500'

DRAWN BY: ECT

DATE: 10-28-16

JOB NO.: 16003



Gray & Associates INC.

CIVIL ENGINEERS * PLANNERS * SURVEYORS

130 Vine Street Reno, Nevada 89503

(775) 329-2911 * (775) 329-6469 Fax * admin@grayassociates.net

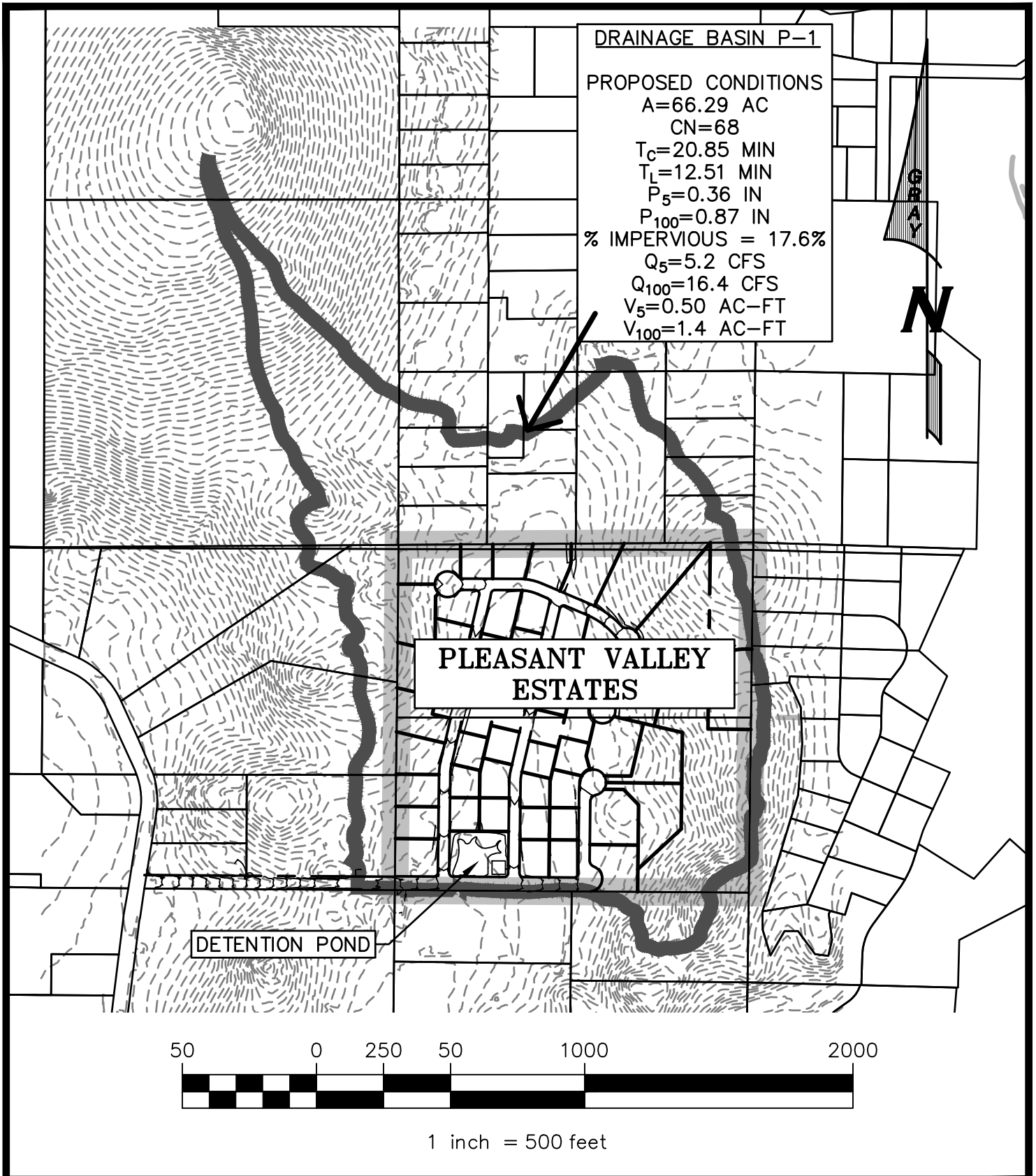

PLEASANT VALLEY ESTATES
 TENTATIVE MAP
 PROPOSED DRAINAGE AREAS

SCALE: 1"=500'

DRAWN BY: ECT

DATE: 10-28-16

JOB NO.: 16003



Gray & Associates INC.

CIVIL ENGINEERS * PLANNERS * SURVEYORS

130 Vine Street Reno, Nevada 89503

(775) 329-2911 * (775) 329-6469 Fax * admin@grayassociates.net

Contents

Hydrology Report.....Pages 1-5

Proposed Rational Method Calculations.....Appendix A

Proposed Pipe, Catch Basin and Ditch Hydraulics.....Appendix B

Proposed Detention Pond Calculations.....Appendix C

Maps and Figures.....Appendix D

Preliminary Sanitary Sewer Report

for

Pleasant Valley Estates

Washoe County, Nevada

Prepared for:

Pleasant Valley Estates, LLC
301 Flint Street
Reno, NV 89501
(775) 846-9200

Prepared by:

Gray & Associates, Inc.
130 Vine Street
Reno, NV 89503
(775) 329-2911

October 26, 2016

P068-16003

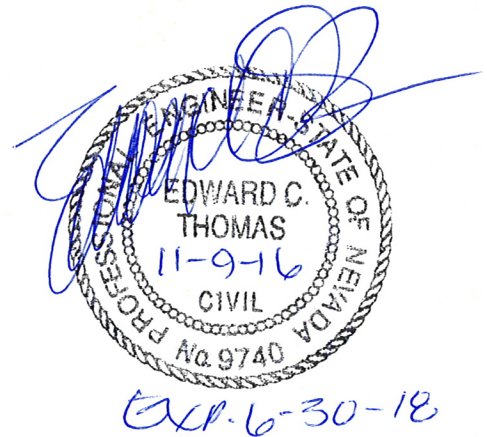

Gray & Associates INC.

SITE DESCRIPTION

This report presents sanitary sewer calculations for the Pleasant Valley Estates Residential Subdivision project. Pleasant Valley Estates is located in the northeastern 1/4 of the northwestern 1/4 of Section 3, T.17N, R.20E., M.D.M. in Washoe County, Nevada. The property consists of two parcels (APN's 017-410-38 and 39; 16100 Rocky Vista Road and 1221 Chance Lane, respectively). The project encompasses 39.34 acres and includes one existing residential structure currently on a well and septic system. The site is located within an isolated small valley between Rhodes Road to the west and Majestic View subdivision/Toll Road on the east.

FLOOD ZONE

According to FEMA Flood Insurance Rate Map No. 32031C3351G, the entire site lies within Flood Hazard Zone X (unshaded) which is defined as areas determined to be outside the 500-year floodplain.

PROJECT DESCRIPTION

Upon completion, the site will consist of approximately 54 Single Family Homes. The nearest existing 8" PVC Sanitary Sewer Main is located in Star Point Drive within the adjacent Majestic View subdivision east of the subject project. The topography of the subject project does not allow for a gravity sewer, and therefore, a force main and pump system is proposed to convey sewage to the nearest existing main. A gravity sewer system will serve the proposed homes and will be routed to a pump located near the southern boundary of the property. The force main will then be routed through the subdivision to an easement located within the Majestic View subdivision into the existing 8" Sanitary Sewer located in Star Point Drive.

No non-domestic wastewater will be introduced into the sanitary sewer system.

SEWER CAPACITY ESTIMATES

The 8" sanitary sewer in Star Point Drive currently serves approximately 30 single family parcels, only a few of which have been developed into homes at present. The existing sewer main flows north into the 8" sanitary sewer in Secret Pass Road which continues north

eventually into the 8" Toll Road Main. While it is conceivable that the isolated sanitary sewer pump system contemplated for the subject property could serve future development upstream, it is unlikely, so future development is not considered in this report.

The following table estimates the total flow generated by the existing parcels currently served by the Star Point Main and estimates future flow from the subject project. Calculations allow for a minimum sewer slope of 0.35% and a Manning's roughness coefficient of 0.012. The capacity of the 8" sanitary sewer in Star Point Drive flowing at 50% capacity is 252,000 gpd (0.39 cfs). The total flow from the project plus the existing flows from the existing sewer main total 67,200 gpd.

Existing System	Flow Calculation	Total Flow
Majestic View	$(270 \text{ gpcpd})(30 \text{ sfh}) \left(3 \frac{\text{cap}}{\text{unit}}\right)$	24,300 gal/day
Proposed Project	Flow Calculation	Total Flow
Pleasant Valley Estates Subdivision	$(270 \text{ gpcpd})(53 \text{ sfh}) \left(3 \frac{\text{cap}}{\text{unit}}\right)$	42,930 gal/day
Combined Flow in Majestic View Sanitary Sewer Main		67,200 gal/day

CONCLUSION

The full capacity of the existing 8" sanitary sewer main in Star Point Drive is approximately 500,000 gpd which is much greater than the proposed and future flows estimated to be reaching the main. Therefore the proposed 67,200 gpd sanitary sewer flows from existing users and the proposed 54 lot project can be easily accommodated by the existing 8" main in Star Point Drive.